

Evaluation Board Report

19V 45W AC-DC power supply

Design Specs	Value	Unit
Input Voltage	85-265	VAC
Output Voltage	19	VDC
Output Current	2.35	A
Isolation	YES	
MPS IC	HFC0400GS	
Application	<ul style="list-style-type: none"> • AC-DC Adapters for Notebooks, etc. • Offline Battery Chargers. • LCD&TV Monitors, etc. 	

Document Number	EBXXX
Author	Application Engineering Department
Date	Nov, 2014
Revision	1.0

Design Summary

EVHFC0400-S-00A evaluation board provides a reference design for a universal offline power supply with 19V, 2.35A output. It contains the complete specification of the power supply, a detailed circuit diagram, the entire bill of materials required to build the power supply, drawing of the power inductors and transformers, and test data of the most important performance.

DESCRIPTION

HFC0400 is a fixed-frequency current mode controller with built-in slope compensation. At light load condition, it freezes the peak current and reduces its switching frequency down to 25kHz. As a result, it offers excellent efficiency at lightload. At very light load, the controller enters burst mode. So very low standby power consumption can be achieved.

HFC0400 offers frequency jittering which helps to spread out energy in conducted noise. It also has the X-CAP discharge function, through the HV Pin signal motoring, which can decrease the No load consumption further.

HFC0400 features variable protections like Thermal Shutdown (TSD), Vcc under Voltage Lockout (UVLO), Over Load Protection (OLP), Over Voltage Protection (OVP), Over Temperature Protection (OTP) and Brown-Out Protection.

The HFC0400 is available in the SOIC8-7A package.

ELECTRICAL SPECIFICATION

Parameter	Symbol	Value	Units
Supply Voltage	V _{IN}	90 - 265	V _{AC}
Output Voltage	V _{OUT}	19	V
Output Current	I _{OUT}	2.35	A

FEATURES

- Fixed-frequency current mode control operation with built-in slope compensation.
- Frequency Foldback down to 25kHz at light load condition
- Burst Mode for low standby power consumption
- Frequency jittering for a reduced EMI signature
- X-CAP discharge function
- Internal high voltage current source
- VCC Under Voltage Lockout with Hysteresis (UVLO)
- Brown-Out Protection on HV pin
- Over Load Protection with programmable delay
- Latch-off for external Over Voltage Protection(OVP) and Over Temperature Protection(OTP) on TIMER Pin
- Thermal Shutdown (auto restart with hysteresis)
- Short Circuit Protection
- Programmable soft start

All MPS parts are lead-free and adhere to the RoHS directive. For MPS green status, please visit MPS website under Quality Assurance.

"MPS" and "The Future of Analog IC Technology", are Registered Trademarks of Monolithic Power Systems, Inc..

EVHFC0400-S -00A EVALUATION BOARD

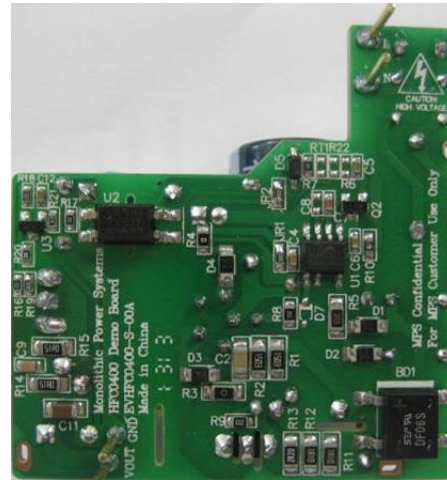

(L x W x H) 53mm x 54mm x 25mm

Board Number	MPS IC Number
EVHFC0400-S -00A	HFC0400GS

EVALUATION BOARD SCHEMATIC

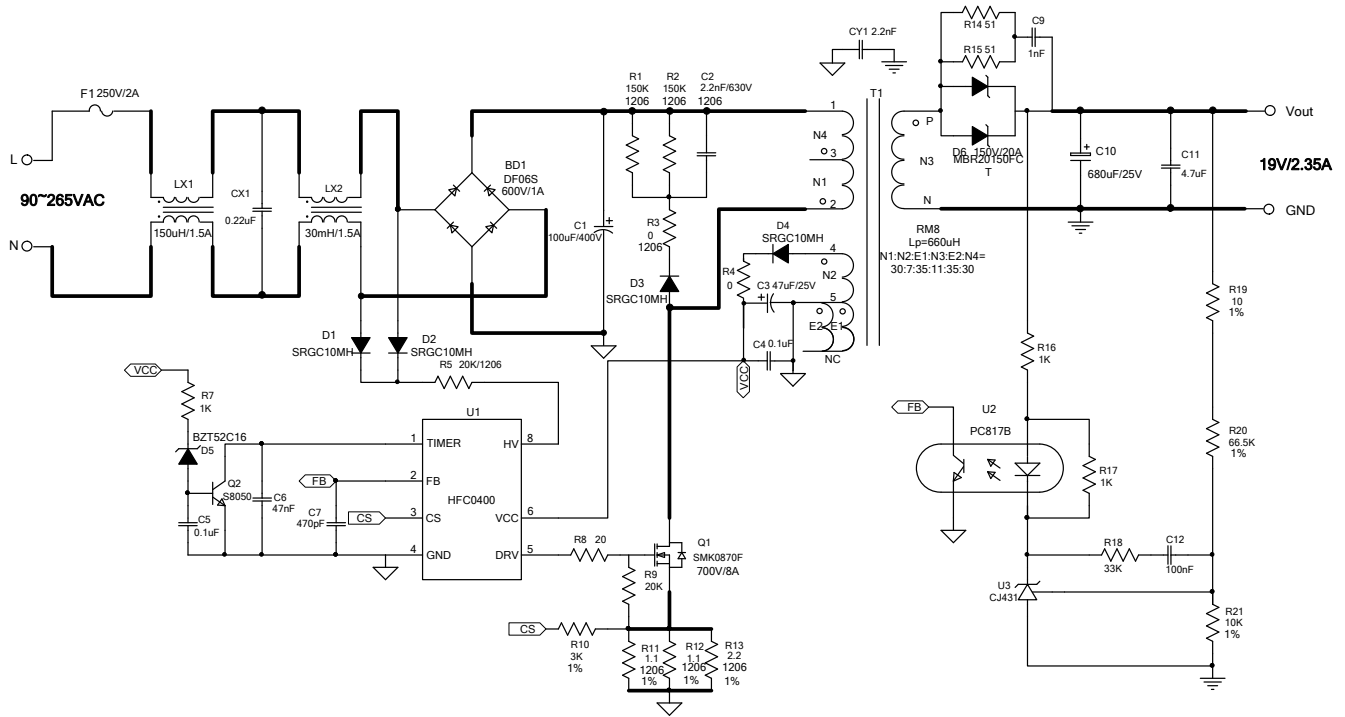

EVHFC0400-S -00A BILL OF MATERIALS

Qty	Ref	Value	Description	Package	Manufacturer	Part Number
1	BD1	DF06S	Diode;600V;1A	SMD	Fairchild	DF06S
1	C1	100μF	Electrolytic Capacitor; 400V;	DIP	Jianghai	CD263-400V100uF
1	C2	2.2nF	Ceramic Capacitor; 630V;X7R;	1206	Murata	GRM31BR72J222KW01L
1	C3	47μF	Electrolytic Capacitor; 25V;	DIP	Jianghai	CD286-25V47uF
3	C4, C5, C12	0.1μF	Ceramic Capacitor; 25V;X7R;	0603	Yageo	CC0603KRX7R8BB104
1	C6	47nF	Ceramic Capacitor; 25V;X7R;	0603	HHEC	C0603X473K025T
1	C7	470pF	Ceramic Capacitor; 50V;C0G;	0603	Murata	GRM1885C1H471JA01D
1	C9	1nF	Ceramic Capacitor; 250V;X7R;	0805	TDK	C2012X7R2E102K
1	C10	680μF	Electrolytic Capacitor; 25V;	DIP	Panasonic	EEU-FR1E681
1	C11	4.7μF	Ceramic Capacitor; 25V;X7R;	1206	TDK	C3216X7R1E475K
1	CX1	0.22μF	Film Capacitor; 275V;10%	DIP	Kaili	PX224K3ID49L270D9R
1	CY1	2.2nF	Capacitor;4000V;20%	DIP	Hongke	JN12E222MY02N
4	D1, D2, D3, D4	SRGC10MH	Diode;1000V;1A	1206	Maxmega	SRGC10MH
1	D5	BZT52C16	ZenerDiode;16V; 5mA/500mW;	SOD123	Diodes	BZT52C16
1	D6	MBR20150FCT	Diode;150V;20A	TO- 220AB	Xutong	MBR20150FCT
1	F1	SS-5-2A	Fuse;250V;2A;	DIP	Cooper Bussmann	SS-5-2A
1	LX1	150μH	Common Inductor; 1.5A;	DIP	Emei	TP4U150-00
1	LX2	30mH	Common Inductor; 1.5A;	DIP	Emei	TP4M30-02
1	Q1	SMK0870F	Mosfet;700V;8A; 0.9Ω;	TO- 220F-3L	AUK	SMK0870F
1	Q2	S8050	25V/05A	SOT-23	Changdian	S8050
2	R1, R2	150kΩ	Film Resistor; 1%;1/4W;	1206	Panasonic	ERJ8ENF1503V
1	R3	0Ω	Film Resistor; 5%;1/4W;	1206	Any	RC1206JR-070RL
1	R4	0Ω	Film Resistor;5%;	0805	Yageo	RC0603FR-071KL
1	R5	20kΩ	Film Resistor; 5%;1/4W;	1206	LIZ	CR1206J40203G
3	R7, R16, R17	1kΩ	Film Resistor;5%;	0603	Yageo	RC0603JR-070RL

EVHFC0400-S-00A BILL OF MATERIALS (continued)

Qty	Ref	Value	Description	Package	Manufacturer	Part Number
1	R8	20Ω	Film Resistor;1%;	0805	Yageo	RC0805JR-0720RL
1	R9	20kΩ	Film Resistor;5%	0805	Yageo	RC0805JR-0720KL
1	R10	3kΩ	Film Resistor;1%;	0603	Yageo	RC0603FR-073KL
2	R11, R12	1.1Ω	Film Resistor; 1%;1/4W;	1206	Yageo	RC1206FR-071R1L
1	R13	2.2Ω	Film Resistor; 1%;1/4W;	1206	Yageo	RC1206FR-072R2L
2	R14, R15	51Ω	Film Resistor; 1%;1/4W;	1206	Yageo	RC1206FR-0751RL
1	R18	33kΩ	Film Resistor;1%;	0603	Yageo	RC0603FR-0733KL
1	R19	10Ω	Film Resistor;1%;	0603	Yageo	RC0603FR-0710RL
1	R20	66.5kΩ	Film Resistor;1%;	0603	Yageo	RC0603FR-0766K5L
1	R21	10kΩ	Film Resistor;1%;	0603	Yageo	RC0603FR-0710KL
1	T1	660μH	RM8;660μH; N1:N2:E1:N3:E2:N4 =30:7:35:11:35:30	DIP	Emei	FX0311
1	U1	HFC0400	PWM Controller	SOIC8-7A	MPS	HFC0400GS
1	U2	PC817B	Photocoupler; 1-Channel;	SMD	Sharp	PC817B
1	U3	CJ431	Shunt Regulator;2.5V;	SOT-23	Changdian	CJ431

TRANSFORMER STRUCTURE

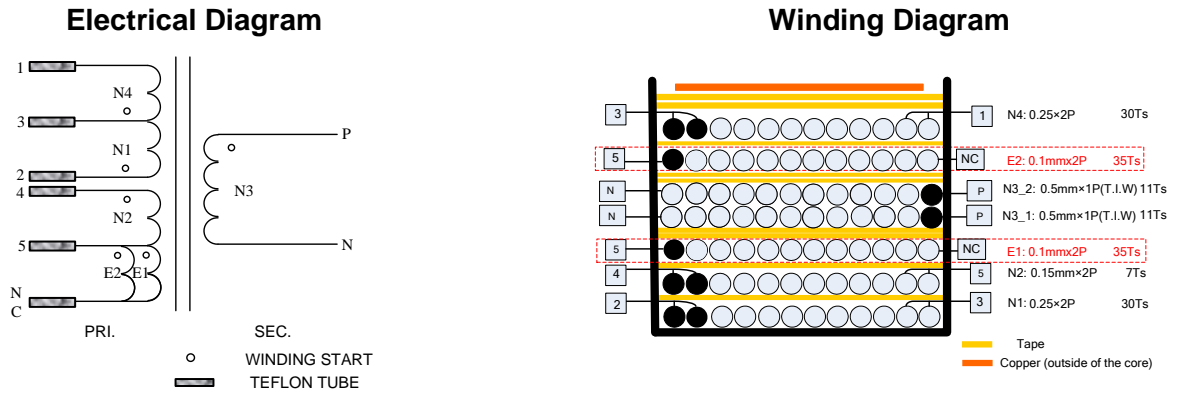

Notes:

1.Round one layer copper outside of the core air gap. And make sure the head and the tail of the copper and connected, then connected the copper to Ground Pin(Pin5).

Pin Definition of Bobbin

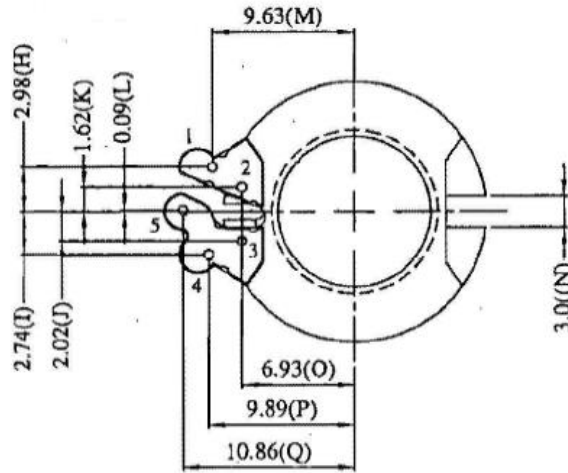

Table 1—Electrical Characteristic

Parameter	Condition	Value
Primary Inductance	L _p (1-2)	660uH±5%
Core		RM8
Bobbin		RM8
Core Material		PC40 or equivalent
Turn Ratio	N1:N2:E1:N3:E2:N4	30:7:35:11:35:30

Table 2—Winding Specification

Tape Turns	Winding No.	Start&End	Wire Diameter (mm)	Turns
1	N1	2→3	0.25×2	30
1	N2	4→5	0.15×2	7
2	E1	5→NC	0.1×2	35
2	N3	P→N	0.5×2(T.I.W)	11
1	E2	5→NC	0.1×2	35
2	N4	3→1	0.25×2	30

EVB TEST RESULTS

Performance waveforms are tested on the evaluation board.

$V_{IN} = 230V_{AC}$, $V_{OUT} = 19V$, $L = 660\mu H$, $T_A = 25^\circ C$, unless otherwise noted.

Efficiency

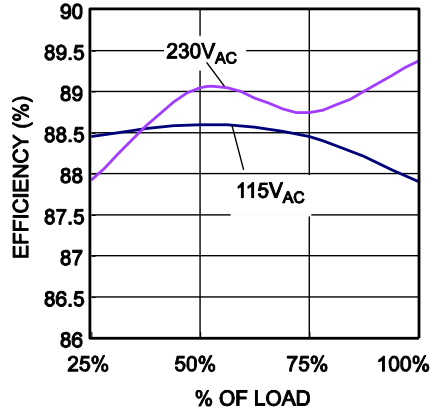

No Load Power Consumption

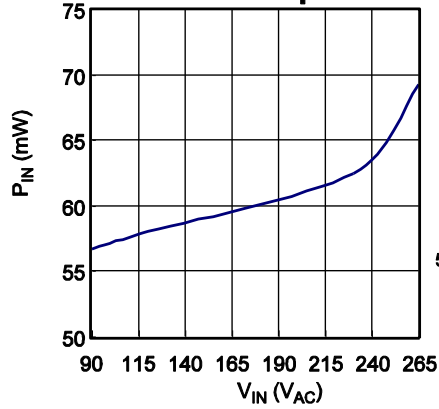

Voltage Stress

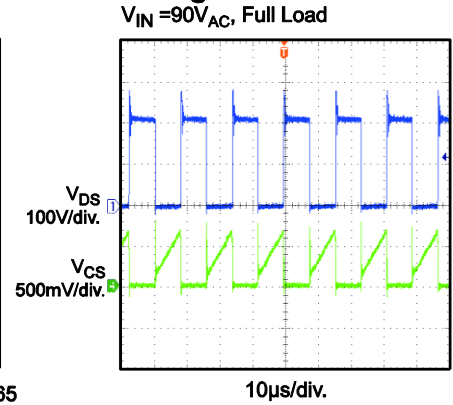

Voltage Stress

$V_{IN} = 265V_{AC}$, Full Load

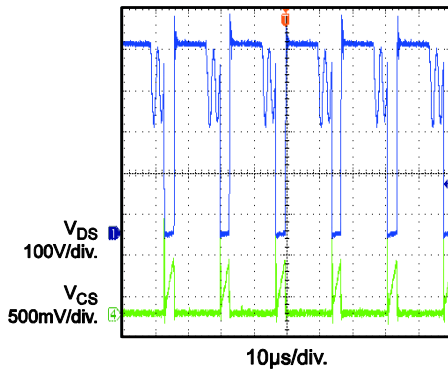

Output Ripple

$V_{IN} = 115V_{AC}$, Full Load

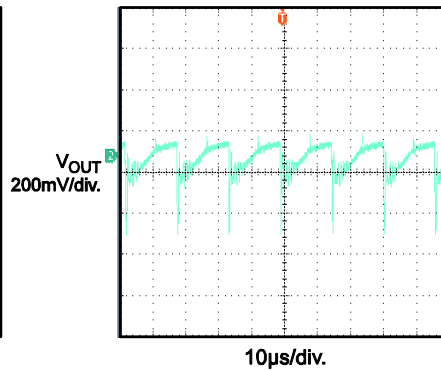

Output Ripple

$V_{IN} = 230V_{AC}$, Full Load

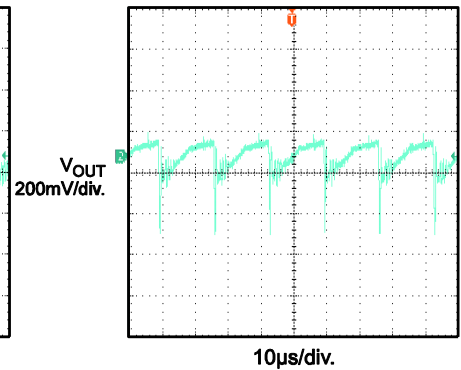

Soft Start

$V_{IN} = 90V_{AC}$, Full Load

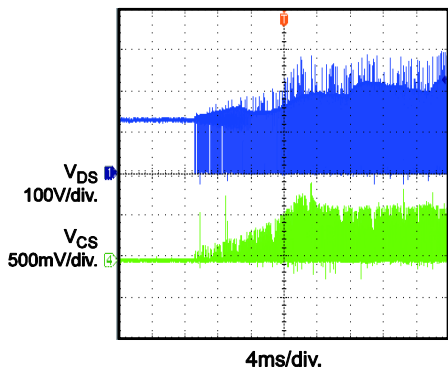

Soft Start

$V_{IN} = 265V_{AC}$, Full Load

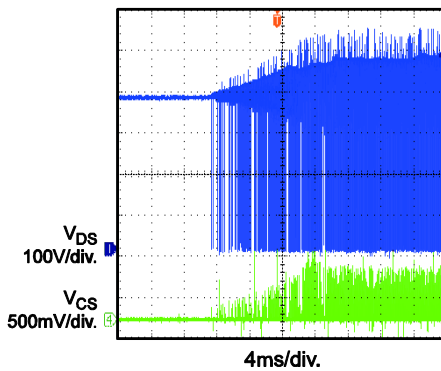

Turn On Delay

$V_{IN} = 115V_{AC}$, Full Load

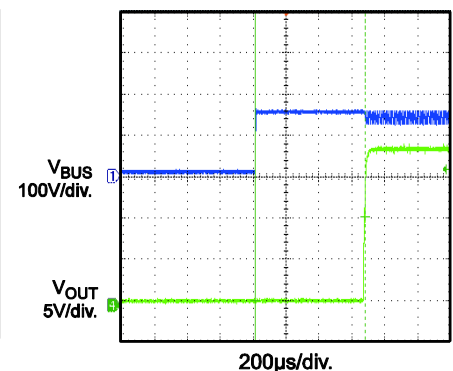

EVB TEST RESULTS *(continued)*

Performance waveforms are tested on the evaluation board.

$V_{IN} = 230V_{AC}$, $V_{OUT} = 19V$, $L = 660\mu H$, $T_A = 25^\circ C$, unless otherwise noted.

Turn on Delay

$V_{IN} = 115V_{AC}$, No Load

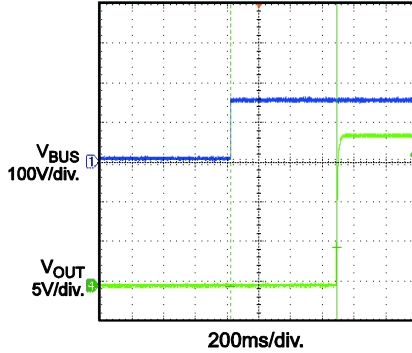

Turn on Delay

$V_{IN} = 230V_{AC}$, Full Load

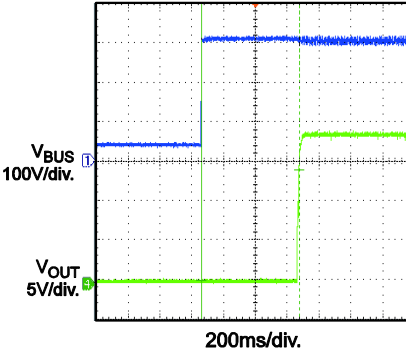

Turn on Delay

$V_{IN} = 230V_{AC}$, No Load

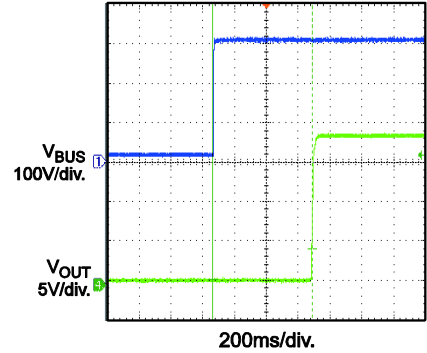

Load Transient

$V_{IN} = 115V_{AC}$, No Load to Full Load

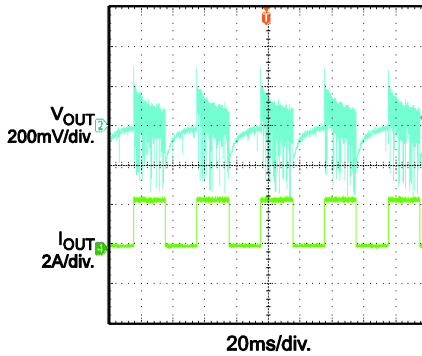

Load Transient

$V_{IN} = 230V_{AC}$, No Load to Full Load

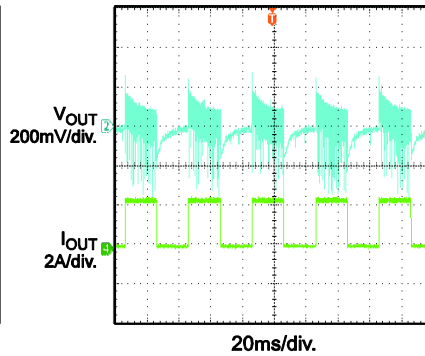

Short Circuit Protection

$V_{IN} = 230V_{AC}$

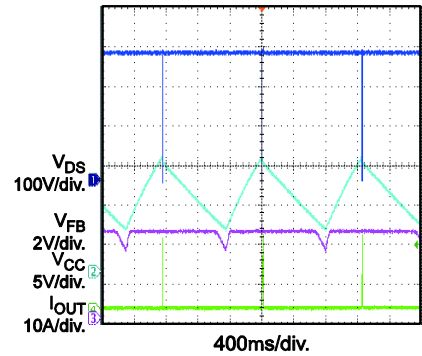

Over Load Protection

$V_{IN} = 230V_{AC}$

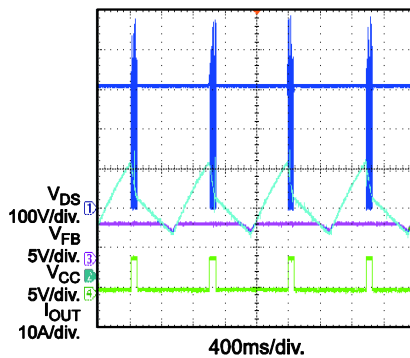

Thermal Shutdown

$V_{IN} = 230V_{AC}$

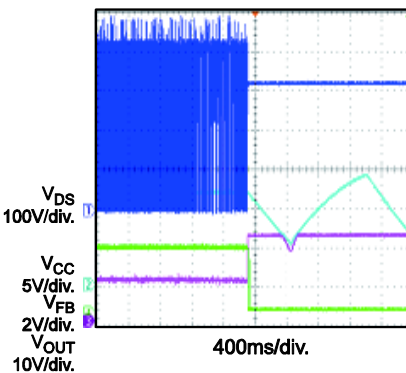

Over Voltage Protection

$V_{IN} = 230V_{AC}$, Full Load

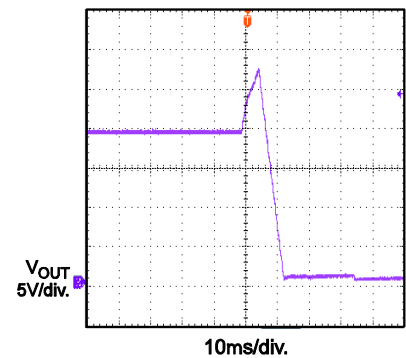

EVB TEST RESULTS *(continued)*

Performance waveforms are tested on the evaluation board.

$V_{IN} = 230V_{AC}$, $V_{OUT} = 19V$, $L = 660\mu H$, $T_A = 25^{\circ}C$, unless otherwise noted.

Over Voltage Protection

$V_{IN} = 230V_{AC}$, No Load

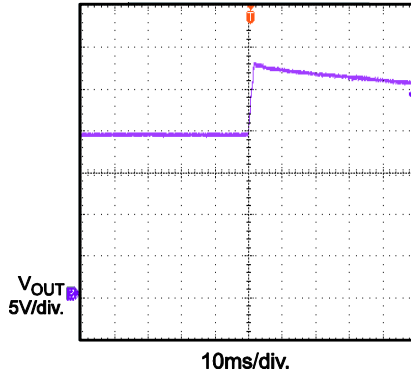

Conducted EMI

115V_{AC} Input L Line

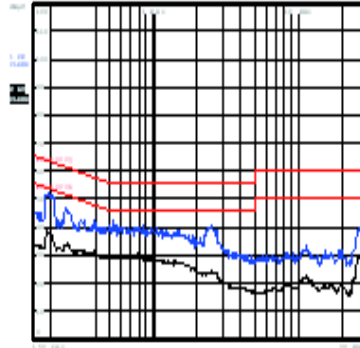

Conducted EMI

115V_{AC} Input N Line

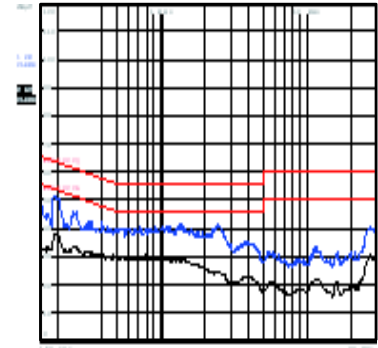

Conducted EMI

230V_{AC} Input L Line

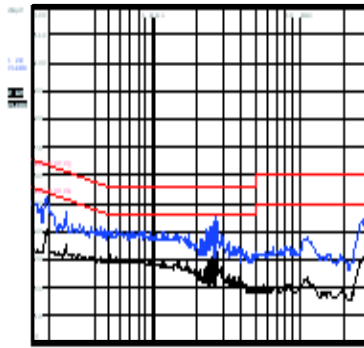

Conducted EMI

230V_{AC} Input N Line

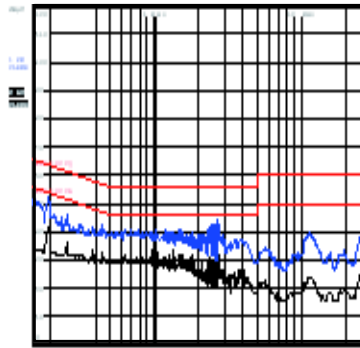

PRINTED CIRCUIT BOARD LAYOUT

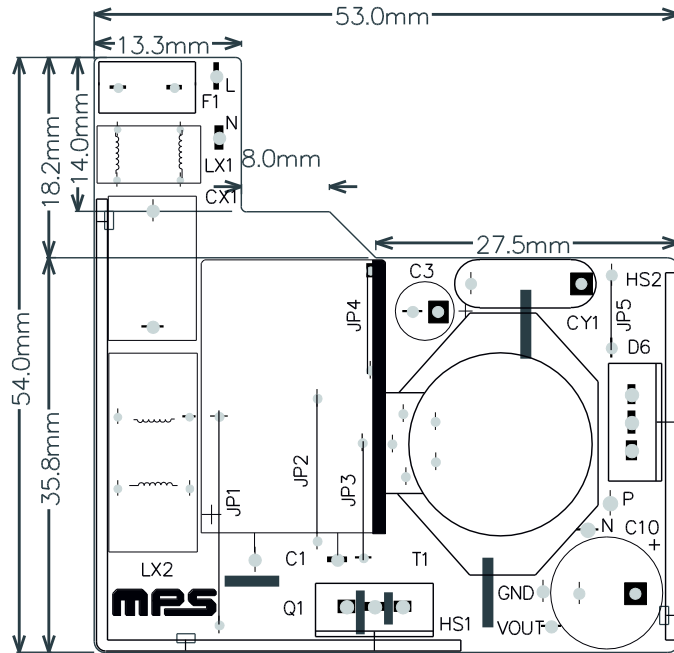

Figure 1 — Top Layer

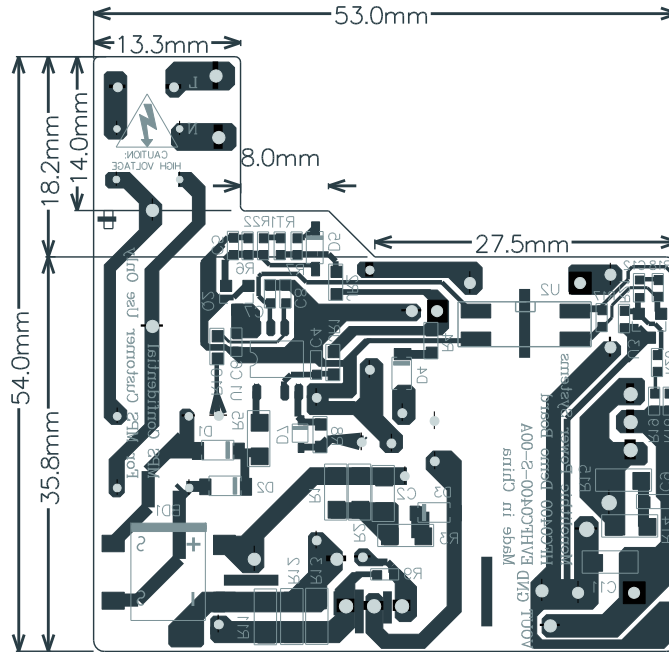

Figure 2 — Bottom Layer

QUICK START GUIDE

1. Preset Power Supply to $90V \leq V_{IN} \leq 265V$.
2. Turn Power Supply off.
3. Connect the power supply output to L and N pins respectively.
4. Connect the positive and negative terminals of the Load to VOUT and GND pins respectively.
5. Turn Power Supply on after making connections.

Contact Information

To request this evaluation board, please refer to your local sales offices which can be found from:

<http://www.monolithicpower.com/Company/Contact-Us>

Disclaimer

Monolithic Power Systems (MPS) reserves the right to make changes to its products and to discontinue products without notice. The applications information, schematic diagrams, and other reference information included herein is provided as a design aid only and are therefore provided as-is. MPS makes no warranties with respect to this information and disclaims any implied warranties of merchantability or non-infringement of third-party intellectual property rights.

MPS cannot assume responsibility for use of any circuitry other than circuitry entirely embodied in a MPS product. No circuit patent licenses are implied.

Certain applications using semiconductor products may involve potential risks of death, personal injury, or severe property or environmental damage (“Critical Applications”).

MPS PRODUCTS ARE NOT DESIGNED, INTENDED, AUTHORIZED, OR WARRANTED TO BE SUITABLE FOR USE IN LIFE-SUPPORT APPLICATIONS, DEVICES OR SYSTEMS, OR OTHER CRITICALAPPLICATIONS.

Inclusion of MPS products in critical applications is understood to be fully at the risk of the customer. Questions concerning potential risk applications should be directed to MPS.

MPS semiconductors are typically used in power supplies in which high voltages are present during operation. High voltage safety precautions should be observed in design and operation to minimize the chance of injury.

NOTICE: The information in this document is subject to change without notice. Please contact MPS for current specifications. Users should warrant and guarantee that third party Intellectual Property rights are not infringed upon when integrating MPS products into any application. MPS will not assume any legal responsibility for any said applications.