

Evaluation Board Report

12V 36W AC-DC power supply

Design Specs	Value	Unit
Input Voltage	85-265	VAC
Output Voltage	12	VDC
Output Current	3	A
Isolation	YES	
MPS IC	HFC0300HS	
Application	<ul style="list-style-type: none"> • Battery charger: cellular phone, digital camera, video camera, electrical shaver, emergency lighting system, etc • Standby power supply: CRT-TV, Projection-TV, LCD-TV, PDP-TV, Desk top PC, Audio system, etc • SMPS: printer, DVD player/recorder, VCR, CD player, Set top box, Air conditioner, refrigerator, washing machine, dish washer, Adapter, etc 	

Document Number	EBXXX
Author	Application Engineering Department
Date	Nov, 2014
Revision	1.0

Design Summary

EVHFC0300HS-00A evaluation board provides a reference design for a universal offline power supply with 12V, 3A output. It contains the complete specification of the power supply, a detailed circuit diagram, the entire bill of materials required to build the power supply, drawing of the power inductors and transformers, and test data of the most important performance.

DESCRIPTION

HFC0300 is a variable off time controller. Based on a fixed peak current technique, the controller decreases its frequency as the load becomes lighter. As a result, it offers excellent efficiency performance at light load while optimizing the efficiency in other load conditions.

When the frequency decreases to some level, peak current decreases with the decrease of the load to prevent transformer mechanical resonance. The controller enters burst mode when the output power falls below a given level.

The HFC0300 features various variable protections like Thermal Shutdown (TSD), V_{CC} Under Voltage Lockout (UVLO), Over Load Protection (OLP), Short Circuit Protection (SCP), Over Voltage Protection (OVP).

The HFC0300 is available in the 8-pin SOIC8 package.

ELECTRICAL SPECIFICATION

Parameter	Symbol	Value	Units
Supply Voltage	V_{IN}	85~265	VAC
Output Voltage	V_{OUT}	12	V
Output Current	I_{OUT}	3	A

FEATURES

- Variable Off Time, Current Mode Control
- Universal Main Supply Operation (85V~265VAC)
- Naturally Frequency Foldback with the Load Becoming Lighter
- Peak Current Compression Reduces the Transformer Noise
- Active Burst Mode for Low Standby Power Consumption
- Internal High Voltage Current Source
- Internal 200ns Leading Edge Blanking
- Thermal Shutdown (auto restart with hysteresis)
- VCC Under Voltage Lockout with Hysteresis (UVLO)
- Over Voltage Protection on VCC Pin
- Timer Based Over Load Protection
- Short Circuit Protection
- Natural Spectrum Shaping for Improved EMI Performance

All MPS parts are lead-free and adhere to the RoHS directive. For MPS green status, please visit MPS website under Quality Assurance.

"MPS" and "The Future of Analog IC Technology", are Registered Trademarks of Monolithic Power Systems, Inc..

EVHFC0300HS-00A EVALUATION BOARD

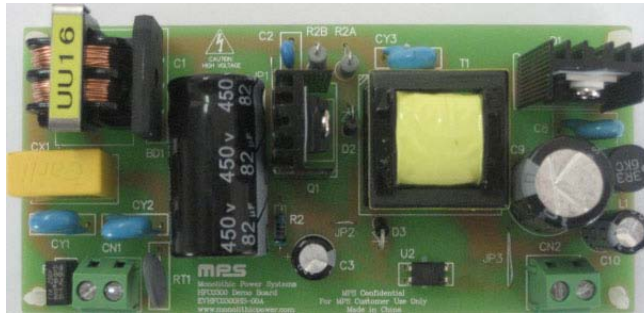

(L x W x H) 12.13cm x 5.66cm x 2.80cm

Board Number	MPS IC Number
EVHFC0300HS-00A	HFC0300HS

EVALUATION BOARD SCHEMATIC

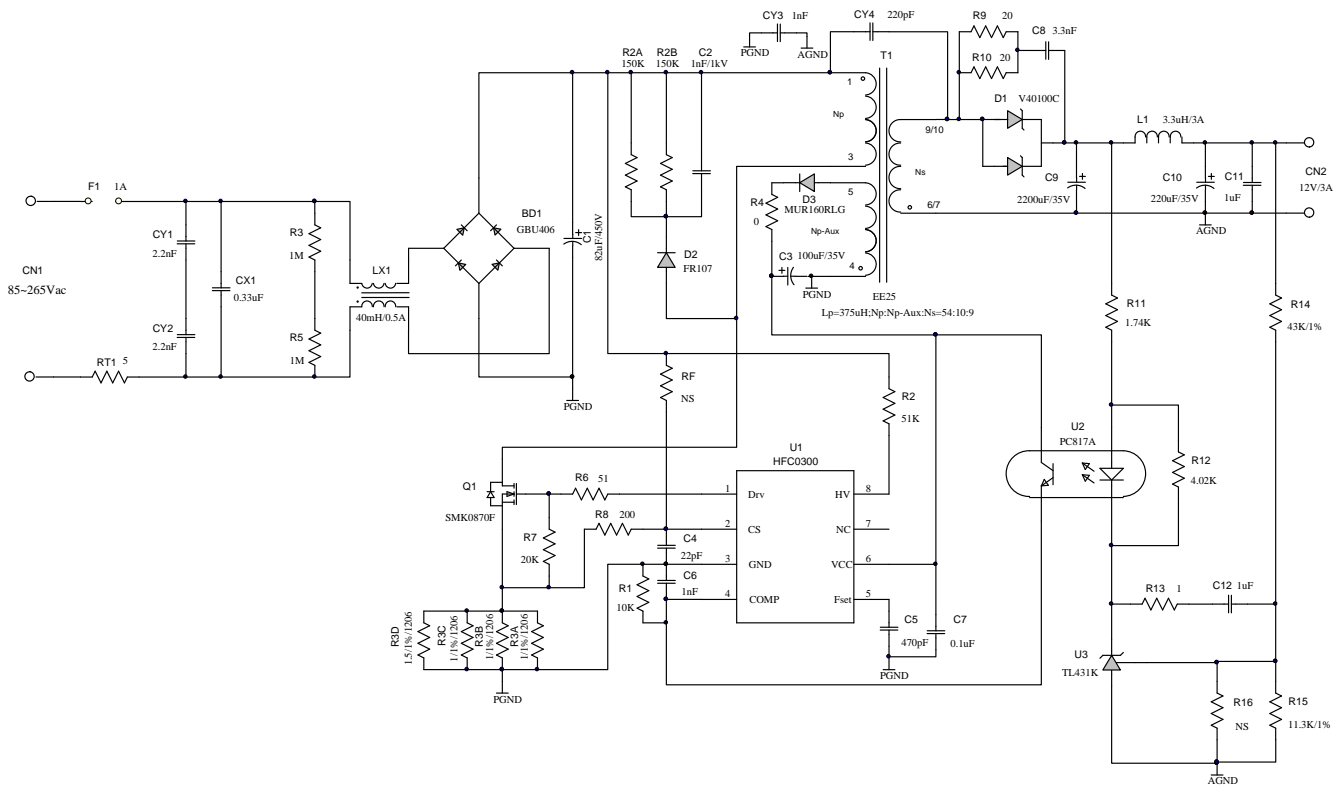

EVHFC0300HS-00A BILL OF MATERIALS

Qty	Ref	Value	Description	Package	Manufacturer	Part Number
1	BD1	GBU406	Diode;600V;4A	Through Hole	Diodes	GBU406
1	C1	82uF/450V	Electrolytic Capacitor;450V;	DIP	Jianghai	CD266-450V82
1	C2	1nF	Ceramic Capacitor;1000V;	DIP	Any'	CAP 1nF/1000V
1	C3	100µF/35V	Electrolytic Capacitor;35V;	DIP	Jianghai	CD287-35V100
1	C4	22pF	Ceramic Capacitor;50V;C0G;	0603	Murate	GRM1885C1H220JA01D
1	C5	470pF	Ceramic Capacitor;50V;C0G;	0603	Murate	GRM1885C1H471JA01
1	C6	1nF	Ceramic Capacitor;50V;X7R;	0603	Murate	GRM188R71H102KA01D
1	C7	0.1µF	Ceramic Capacitor;50V;X7R;	0603	Murate	GRM188R71H104KA93D
1	C8	3.3nF	Ceramic Capacitor;250V;E;	DIP	Murata	DE1E3KX332MA4BL01
1	C9	2200µF/35V	Electrolytic Capacitor;35V;	DIP	Rubycon	2200uF/35V
1	C10	220µF/35V	Electrolytic Capacitor;35V;	DIP	Jianghai	CD287-35V220
1	C11	1µF	Ceramic Capacitor;50V;X7R;	1206	Murata	GRM31MR71H105KA88L
1	C12	1µF	Ceramic Capacitor;25V;X7R;	0603	Murata	GRM188R71E105KA12
2	CN1, CN2		Connector-2Pins,5mm;	Through Hole	Any	Any
1	CX1	0.33µF	Film Capacitor;275V;10%;	DIP	Kaili	PX334K31D49L270D9R
2	CY1, CY2	2.2nF	Y1 Capacitor;4000V;20%;	DIP	Hongke	JN12E222MY02N
1	CY3	1nF	Y1 Capacitor;4000V;20%;	DIP	Hongke	JNK09E102MY02N
1	CY4	220pF	Y1 Capacitor;4000V;10%;	DIP	Hongke	JYK08B221KY72N
1	D1	V40100C	Diode,100V,40A;	TO-220AB	Vishay	V40100C
1	D2	FR107	Diode;1000V;1A;	DO-41	Diodes	FR107
1	D3	MUR160RLG	Diode;600V;1A;	DO-41	Diodes	MUR160RLG
1	F1	1A	FUSE,250V;	DIP	CooperBusmann	SS-5-1A
3	JP1, JP2, JP3		Short Connection;			
1	L1	3.3µH	Inductor;3.3uH,3A;	DIP	Any	Any
1	LX1	40mH	Common Filter;	Through Hole	Any	Any
1	Q1	SMK0870F	N-Channel Mosfet;700V;8A;	TO-220F-3L	AUK	SMK0870F

EVHFC0300HS-00A BILL OF MATERIALS (continued)

Qty	Ref	Value	Description	Package	Manufacturer	Part Number
1	R1	10kΩ	Film Resistor;1%;	0603	Yageo	RC0603FR-0710KL
1	R2	51kΩ	Resistor;1%;1/4W;	DIP	Any	51K Ohm DIP Resistor
2	R2A, R2B	150kΩ	Resistor;5%;1W;	DIP	Any	150K Ohm DIP Resistor
2	R3,R5	1MΩ	Film Resistor;5%;	1206	Yageo	RC1206FR-071ML
3	R3A, R3B, R3C	1Ω	Film Resistor;1%;	1206	Royalohm	1206F100KT5E
1	R3D	1.5Ω	Film Resistor;1%;	1206	Royalohm	1206F150KT5E
1	R4	0Ω	Film Resistor;5%;	1206	Yageo	RC1206JR-070RL
1	R6	51Ω	Film Resistor;1%;	1206	Yageo	RC1206FR-0751RL
1	R7	20kΩ	Film Resistor;5%;	1206	LIZ	CR1206J40203G
1	R8	200Ω	Film Resistor;1%;	0603	Yageo	RC0603FR-07200RL
2	R9, R10	20Ω	Film Resistor;5%;	1206	Any	1206J0200T5E
1	R11	1.74kΩ	Film Resistor;1%;	0603	Yageo	RC0603FR-071K74L
1	R12	4.02kΩ	Film Resistor;1%	0603	Yageo	RC0603FR-074K02L
1	R13	1Ω	Film Resistor;5%;	0603	LIZ	CR0603JA01R0G
1	R14	43kΩ	Film Resistor;1%;	0603	LION	RC0603FR-0743KL
1	R15	11.3kΩ	Film Resistor;1%;	0603	Yageo	RC0603FR-0711K3L
1	RT1	5Ω	NTC;	DIP	Xinshun	5D2-10
1	T1	FX0176	EE25,375μH,54:10:9;	Though Hole	UM Electronic	FX0176
1	U1	HFC0300	Controller;	SOIC8	MPS	HFC0300HS
1	U2	PC817A	Photocoupler;1-Channel;	DIP	Sharp	PC817A
1	U3	TL431K	Shunt Regulator,2.5V;	SOT-23	Unisonic	TL431K

TRANSFORMER STRUCTURE

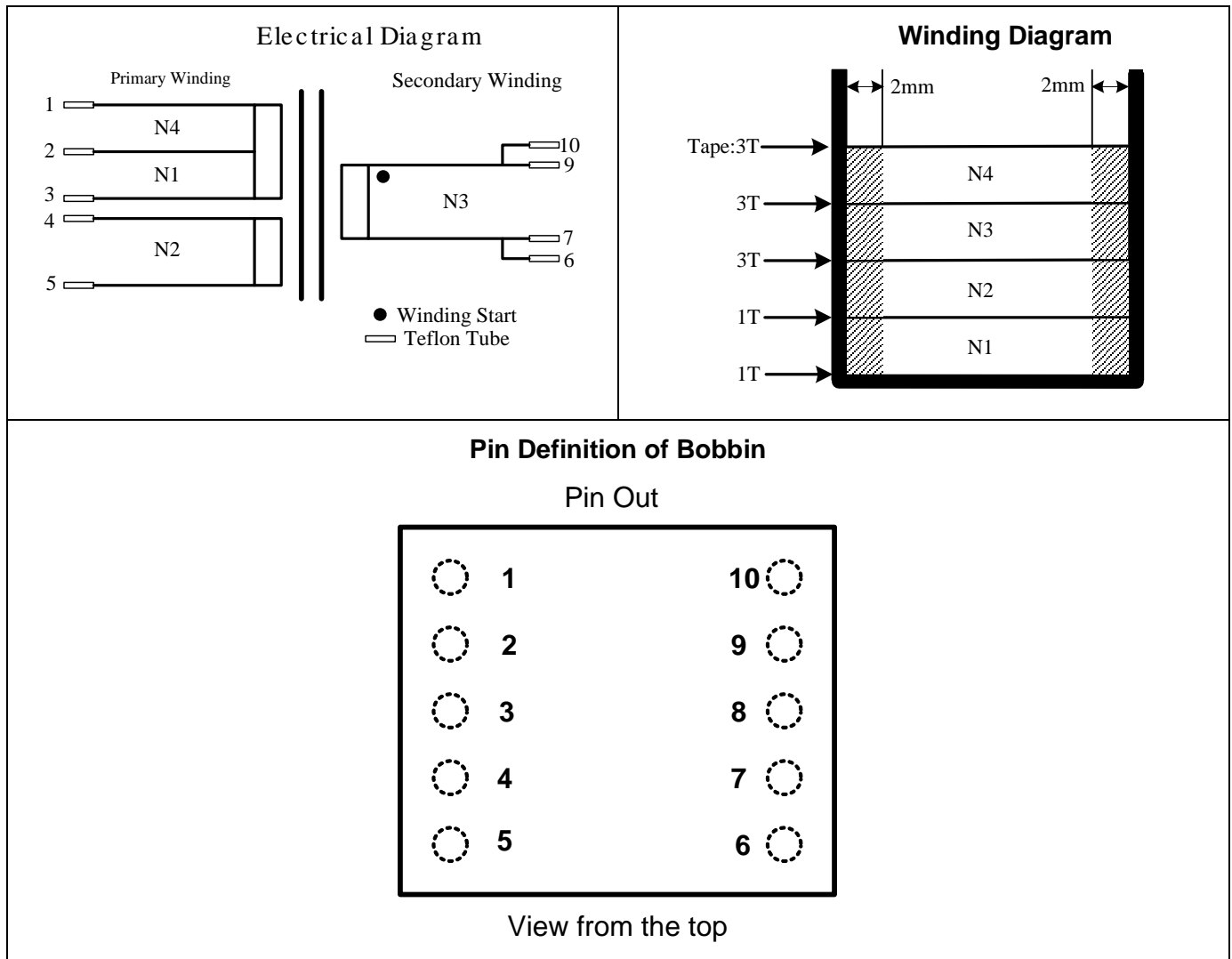

Table 1—Electrical Characteristic

Parameter	Condition	Value
Primary Inductance	Lp(3-1)	375 μ H \pm 10%
Core		EE25
Bobbin		EF25
Core Material		PC40 or equivalent
Turn Ratio	N1:N2:N3:N4	27:10:9:27

Table 2—Winding Specification

Tape Turns	Winding No.	Margin Tapes	Start&End	Wire Diameter (mm)	Turns
1	N1	2mm	3→2	0.20×3	27
1	N2	2mm	5→4	0.20×1	10
3	N3	2mm	9,10→6,7	0.30×10	9
3	N4	2mm	2→1	0.20×3	27

EV BOARD TEST RESULTS

Performance waveforms are tested on the evaluation board.

$V_{IN} = 230VAC$, $V_{OUT} = 12V$, $L = 375\mu H$, $T_A = 23^\circ C$, unless otherwise noted.

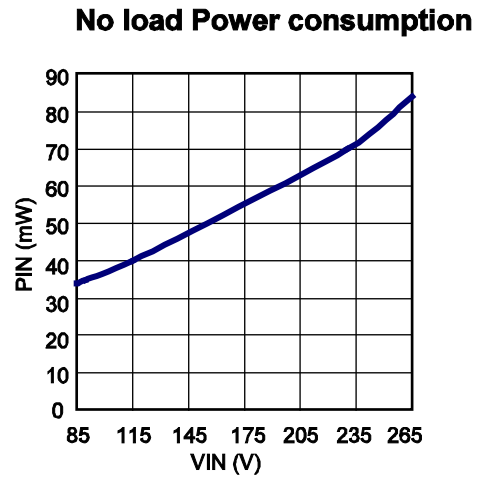
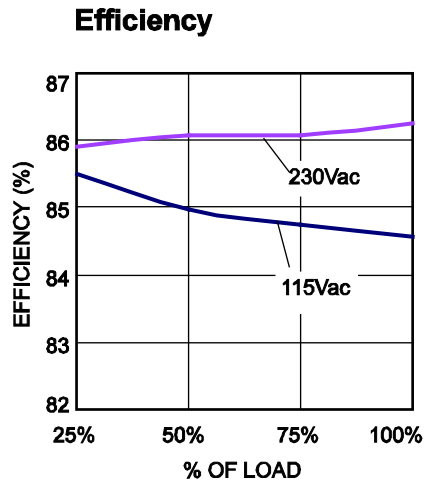

EVB TEST RESULTS *(continued)*

Performance waveforms are tested on the evaluation board.

$V_{IN} = 230VAC$, $V_{OUT} = 12V$, $L = 375\mu H$, $T_A = 23^\circ C$, unless otherwise noted.

Voltage Stress

$V_{IN} = 85Vac$

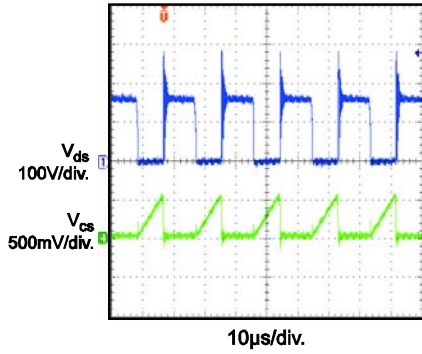

Voltage Stress

$V_{IN} = 265Vac$

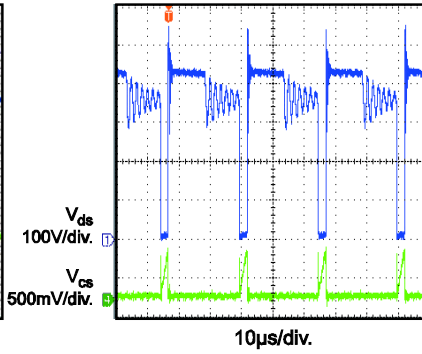

Output Ripple

$V_{in} = 115Vac$ Full Load

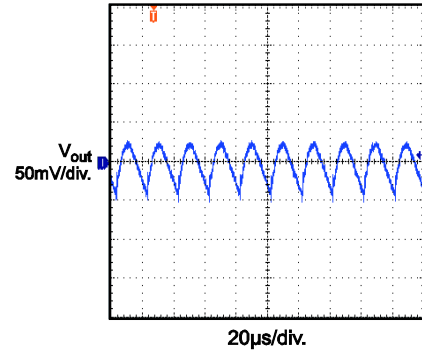

Output Ripple

$V_{in} = 115Vac$ No Load

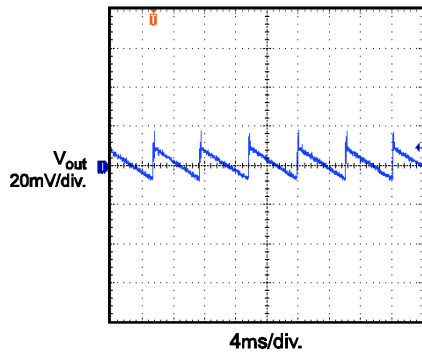

Output Ripple

$V_{in} = 230Vac$ Full Load

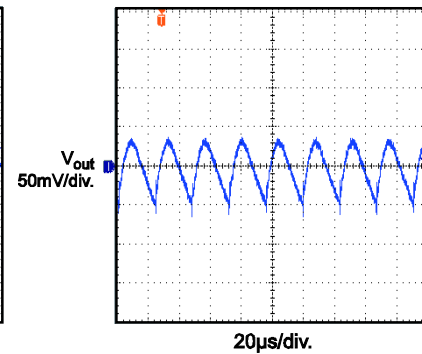

Output Ripple

$V_{in} = 230Vac$ No Load

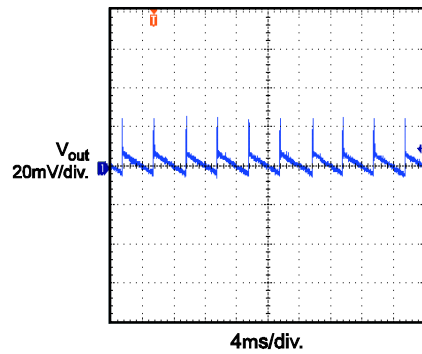

Soft Start

$V_{IN} = 85Vac$

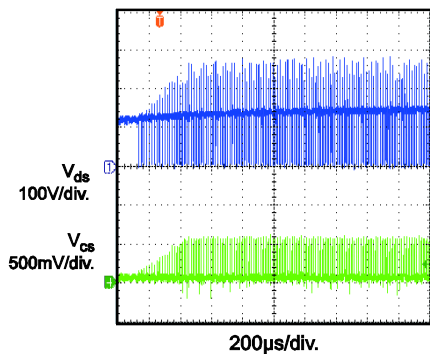

Soft Start

$V_{IN} = 265Vac$

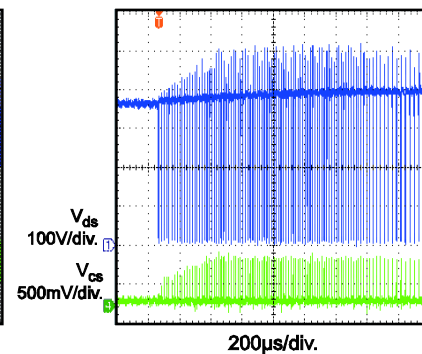

Turn on Delay

$V_{IN} = 115Vac$ Full load

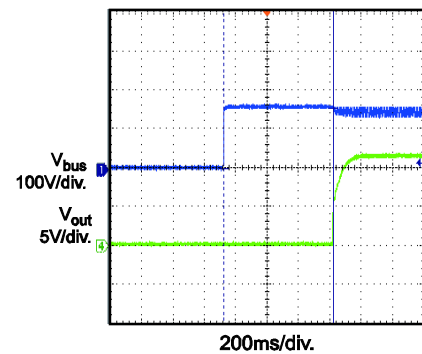

EVB TEST RESULTS *(continued)*

Performance waveforms are tested on the evaluation board.

$V_{IN} = 230VAC$, $V_{OUT} = 12V$, $L = 375\mu H$, $T_A = 23^\circ C$, unless otherwise noted.

Turn on Delay
 $V_{IN} = 115Vac$ No load

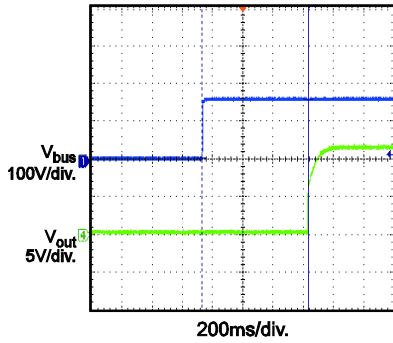

Turn on Delay
 $V_{IN} = 230Vac$ Full load

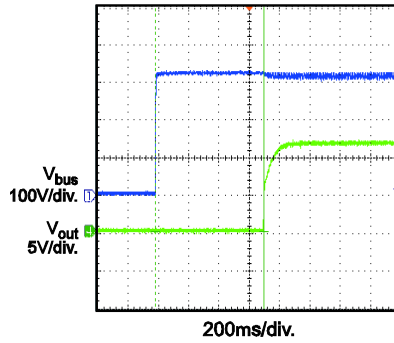

Turn on Delay
 $V_{IN} = 230Vac$ No load

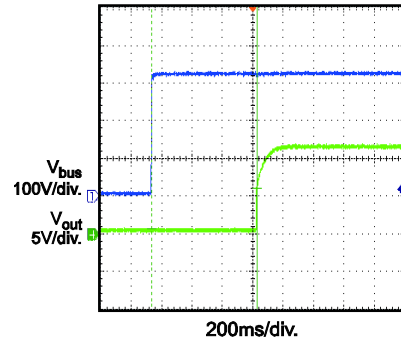

Load Transient
 $V_{IN} = 115Vac$ 25% to 50%

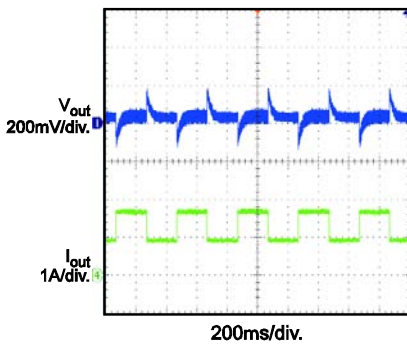

Load Transient
 $V_{IN} = 115Vac$ 50% to 75%

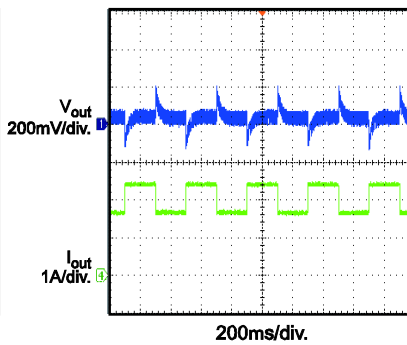

Load transient
 $V_{IN} = 230Vac$ 25% to 50%

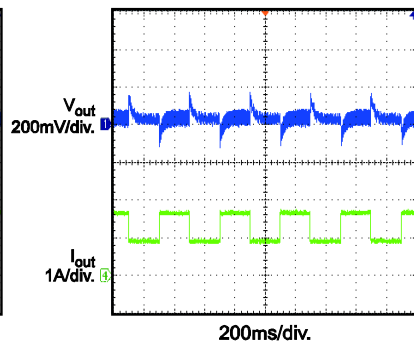

Load Transien
 $V_{IN} = 230Vac$ 50% to 75%

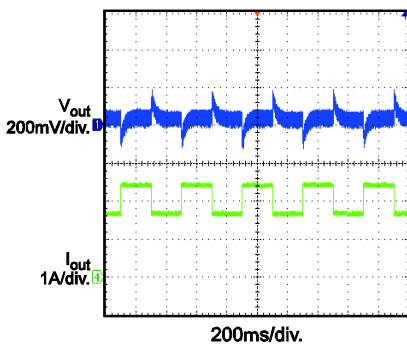

Protection
 $V_{IN} = 230Vac$ short circuit protection

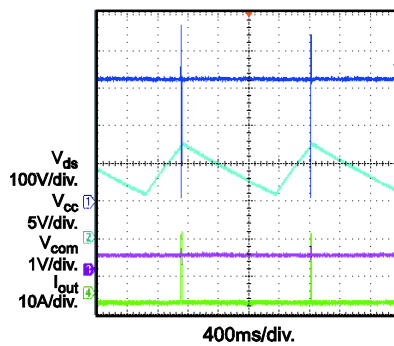

Protection
 $V_{IN} = 230Vac$ Over load protection

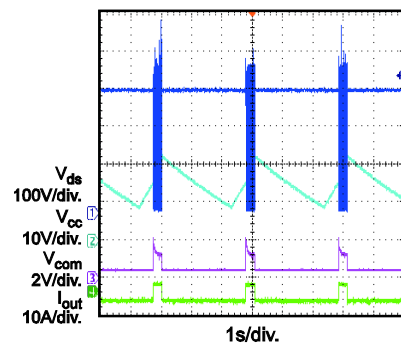

EVB TEST RESULTS *(continued)*

Performance waveforms are tested on the evaluation board.

$V_{IN} = 230VAC$, $V_{OUT} = 12V$, $L = 375\mu H$, $T_A = 23^{\circ}C$, unless otherwise noted.

Thermal Shutdown

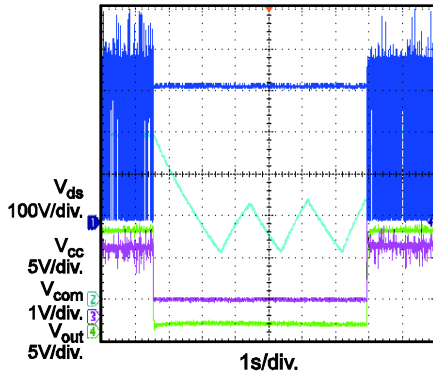

Over Voltage Protection Full load

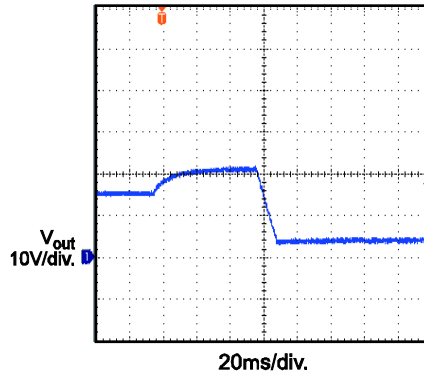

Over Voltage Protection No load

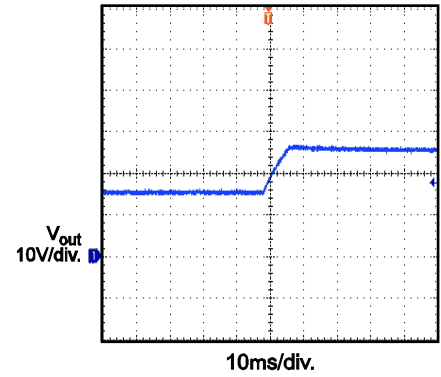

Conducted EMI two line 115Vac

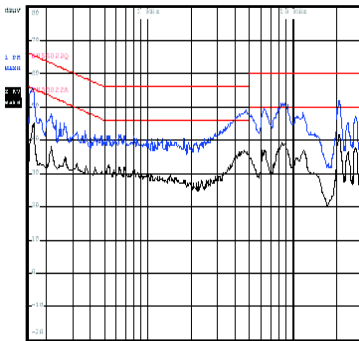

Conducted EMI two line 230 vac

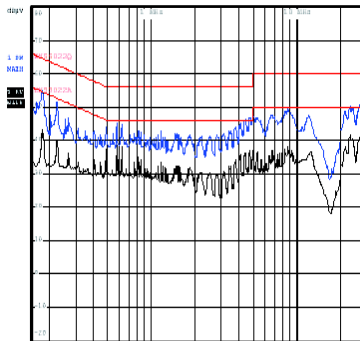

PRINTED CIRCUIT BOARD LAYOUT

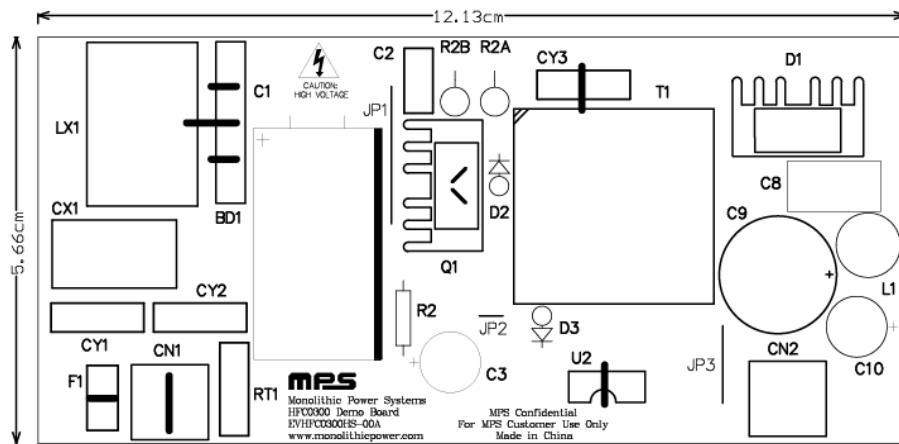

Figure 1 — Top Silk Layer

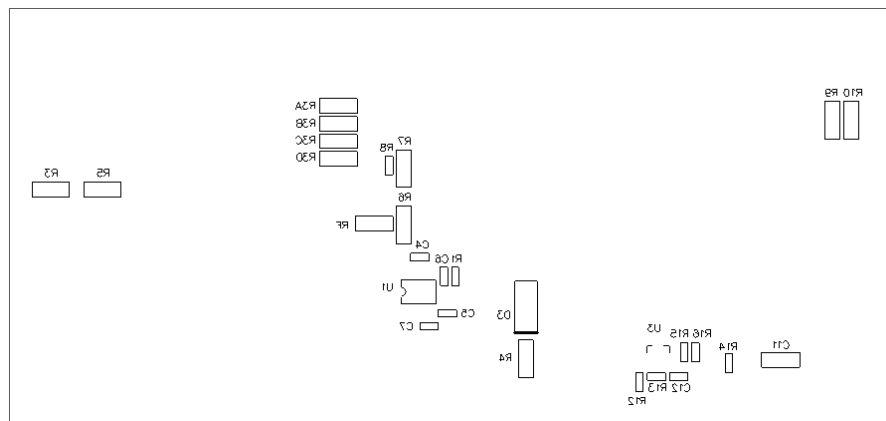

Figure 2 — Bottom Silk Layer

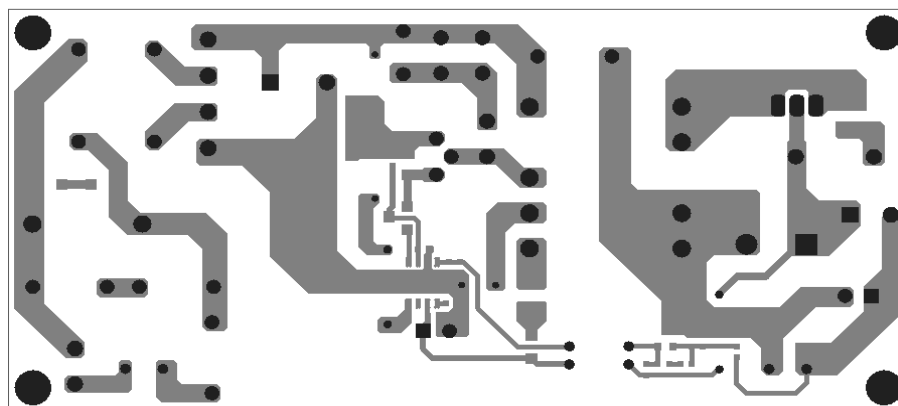

Figure 3 — Bottom Layer

QUICK START GUIDE

1. Preset Power Supply to $85V \leq V_{IN} \leq 265V$.
2. Turn Power Supply off.
3. Connect the Line and Neutral terminals of the power supply output to CN1 port.
4. Connect Load to CN2.
5. Turn Power Supply on after making connections.

Contact Information

To request this evaluation board, please refer to your local sales offices which can be found from:

<http://www.monolithicpower.com/Company/Contact-Us>

Disclaimer

Monolithic Power Systems (MPS) reserves the right to make changes to its products and to discontinue products without notice. The applications information, schematic diagrams, and other reference information included herein is provided as a design aid only and are therefore provided as-is. MPS makes no warranties with respect to this information and disclaims any implied warranties of merchantability or non-infringement of third-party intellectual property rights.

MPS cannot assume responsibility for use of any circuitry other than circuitry entirely embodied in a MPS product. No circuit patent licenses are implied.

Certain applications using semiconductor products may involve potential risks of death, personal injury, or severe property or environmental damage (“Critical Applications”).

MPS PRODUCTS ARE NOT DESIGNED, INTENDED, AUTHORIZED, OR WARRANTED TO BE SUITABLE FOR USE IN LIFE-SUPPORT APPLICATIONS, DEVICES OR SYSTEMS, OR OTHER CRITICALAPPLICATIONS.

Inclusion of MPS products in critical applications is understood to be fully at the risk of the customer. Questions concerning potential risk applications should be directed to MPS.

MPS semiconductors are typically used in power supplies in which high voltages are present during operation. High voltage safety precautions should be observed in design and operation to minimize the chance of injury.

NOTICE: The information in this document is subject to change without notice. Please contact MPS for current specifications. Users should warrant and guarantee that third party Intellectual Property rights are not infringed upon when integrating MPS products into any application. MPS will not assume any legal responsibility for any said applications.