

Evaluation Board Report

39W ACDC power supply

Design Specs	Value	Unit
Input Voltage	85-265	VAC
Output 1	16V, 1.5A	
Output 2	5V, 3A	
Isolation	YES	
MPS IC	HFC0500GS	
Application	TV and Monitors. AC-DC Power Supply with additional 5V output	

Document Number	EBXXX
Author	Application Engineering Department
Date	Nov, 2014
Revision	1.0

Design Summary

EVHFC0500-S-00A evaluation board provides a reference design for a universal offline power supply with 16V, 1.5A and 5V, 3A output. It contains the complete specification of the power supply, a detailed circuit diagram, the entire bill of materials required to build the power supply, drawing of the power inductors and transformers, and test data of the most important performance.



The Future of Analog IC Technology®

EVHFC0500-S-00A

Full Features Controller

EV Board

PRELIMINARY SPECIFICATIONS SUBJECT TO CHANGE

DESCRIPTION

The EVHFC0500-S-00A Evaluation Board is designed to demonstrate the capabilities of HFC0500. HFC0500 is a fixed-frequency current mode controller with built-in slope compensation. At light load condition, it freezes the peak current and reduces its switching frequency down to 25kHz. As a result, it offers excellent efficiency at light load. At very light load, the controller enters burst mode. So very low standby power consumption can be achieved.

The EVHFC0500-S-00A is designed for TV, monitor and it typically drives 39W with dual outputs. One is 16V_{TYP}, 1.5A load and the other is 5V_{TYP}, 3A load from 90V_{AC}/60Hz to 265V_{AC}/50Hz.

The EVHFC0500-S-00A has excellent efficiency and meets 2kV IEC61000-4-5 surge immunity and EN55022 conducted EMI requirements. HFC0500 features variable protections like Thermal Shutdown (TSD), Vcc under Voltage Lockout (UVLO), Over Load Protection (OLP), Over Voltage Protection (OVP), Over Temperature Protection (OTP) and Brown-Out Protection.

HFC0500 is available in the SOIC8-7A package.

ELECTRICAL SPECIFICATION

Parameter	Symbol	Value	Units
Supply Voltage	V _{AC}	90 - 265	V _{AC}
Output Voltage 1	V _{OUT1}	5.0	V
Output Current 1	I _{OUT1}	3.0	A
Output Voltage 2	V _{OUT2}	16.0	V
Output Current 2	I _{OUT2}	1.5	A

FEATURES

- Fixed-frequency current mode control operation with built-in slope compensation.
- Frequency Foldback down to 25kHz at light load condition
- Burst Mode for low standby power consumption
- Frequency jittering for a reduced EMI signature
- X-CAP discharge function
- Internal high voltage current source
- VCC Under Voltage Lockout with Hysteresis (UVLO)
- Brown-Out Protection on HV pin
- Over Load Protection with programmable delay
- Latch-off for external Over Voltage Protection(OVP) and Over Temperature Protection(OTP) on TIMER Pin
- Thermal Shutdown (auto restart with hysteresis)
- Short Circuit Protection
- Programmable soft start

All MPS parts are lead-free and adhere to the RoHS directive. For MPS green status, please visit MPS website under Quality Assurance.

"MPS" and "The Future of Analog IC Technology", are Registered Trademarks of Monolithic Power Systems, Inc..

EVHFC0500-S-00A EVALUATION BOARD

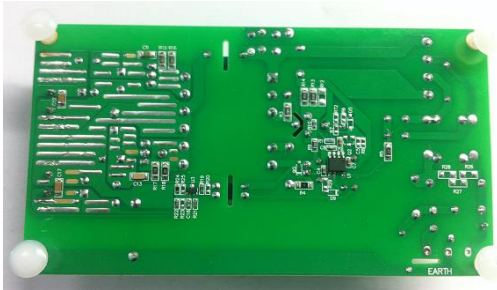

(L x W x H) 130mm x 70mm x 30mm

Board Number	MPS IC Number
EVHFC0500-S-00A	HFC0500GS

VALUATION BOARD SCHEMATIC

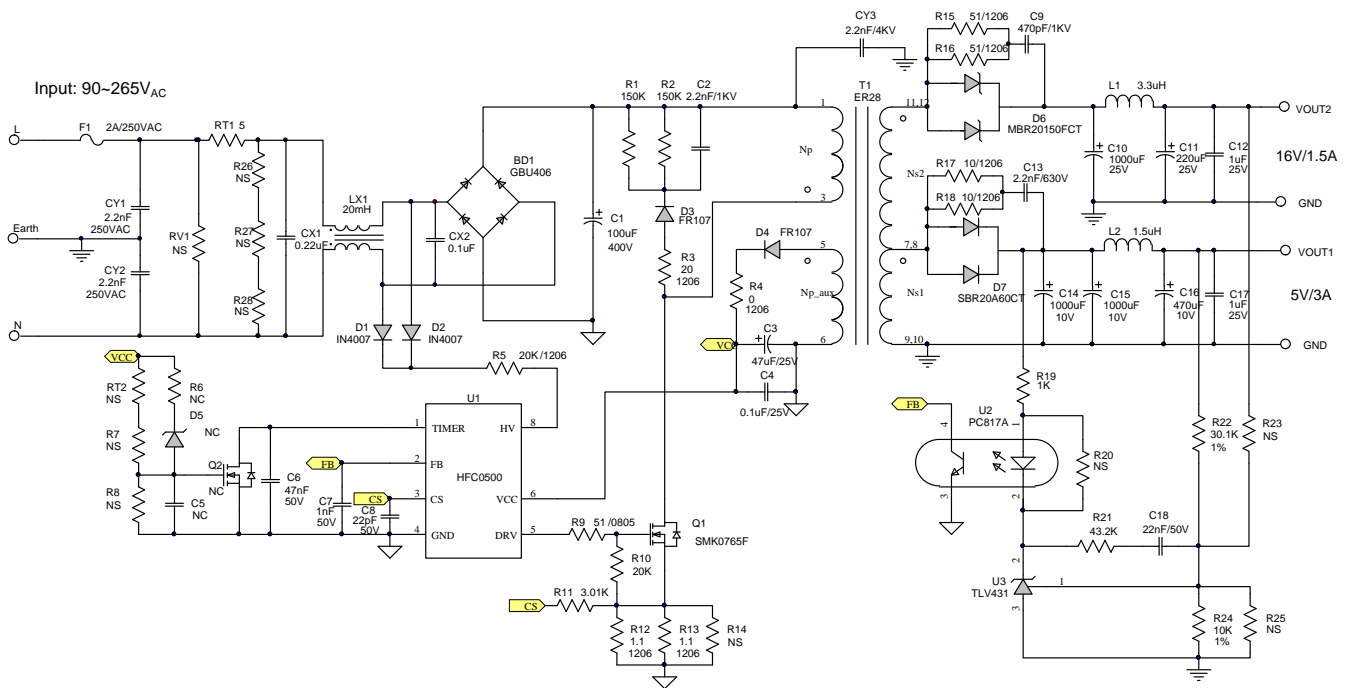

EVHFC0500-S-00A BILL OF MATERIALS

Qty	Ref	Value	Description	Package	Manufacturer	Part Number
1	BD1	GBU406	Diode;600V;4A	DIP	Diodes	GBU406
1	C1	100µF	Electrolytic Capacitor; 400V	DIP	Jianghai	CD263-400V100
1	C2	2.2nF	Capacitor;1000V	DIP	Any	
1	C3	47µF	Electrolytic Capacitor; 25V	DIP	Jianghai	CD28L-25V47
1	C4	0.1µF	Ceramic Capacitor; 25V;X7R	0603	Yageo	CC0603KRX7R8BB104
0	C5	NS				
1	C6	47nF	Ceramic Capacitor; 50V;X7R	0603	muRata	GRM188R71H473KA61D
1	C7	1nF	Ceramic Capacitor; 50V;X7R	0603	muRata	GRM188R71H102KA01D
1	C8	22pF	Ceramic Capacitor; 50V;C0G	0603	muRata	GRM1885C1H220JA01D
1	C9	470pF	Ceramic Capacitor; 1000V;U2J	1206	muRata	GRM31B7U3A471JW31L
1	C10	1000µF	Electrolytic Capacitor; 25V;	DIP	Panasonic	
1	C11	220µF	Electrolytic Capacitor; 25V;	DIP	Jianghai	CD287-25V220
2	C12, C17	1µF	Ceramic Capacitor; 25V;X7R	1206	muRata	GRM31MR71E105KA01
1	C13	2.2nF	Ceramic Capacitor; 250V;X7R	1206	Any	
2	C14, C15	1000µF	Electrolytic Capacitor; 10V	DIP	Jianghai	CD287-10V1000
1	C16	470µF	Electrolytic Capacitor; 10V	DIP	Jianghai	CD287-10V470
1	C18	22nF	Ceramic Capacitor; 50V;X7R	0603	muRata	GRM188R71H223KA01D
1	CX1	0.22µF	Film Capacitor; 275V;10%	DIP	Carli	PX224K3ID49L270D9R
1	CX2	0.1µF	Film Capacitor; 275V;10%	DIP	Carli	PX104K3IC39L270D9R
2	CY1, CY2	2.2nF	Y Capacitor; 250V;20%	DIP	Hongke	JY09F222ML72N
1	CY3	2.2nF	Capacitor;4000V;20%	DIP	Hongke	JN12E222MY02N
2	D1, D2	1N4007	Diode;1000V;1A	DO-41	Diodes	1N4007
2	D3,D 4	FR107	Diode;1000V;1A	DO-41	Diodes	FR107
0	D5, D8, D9	NS				
1	D6	MBR20150FCT	Diode;150V;20A	TO- 220AB	PANJIT	MBR20150FCT

EVHFC0500-S-00A BILL OF MATERIALS (continued)

Qty	Ref	Value	Description	Package	Manufacturer	Part Number
1	D7	SBR20A60CT	Diode;60V;20A	TO-220AB	Diodes	SBR20A60CT
1	F1	SS-5-2A	Fuse;250V;2A	DIP	COOPER BUSSMANN	SS-5-2A
1	L1	3.3 μ H	Inductor;3.3 μ H; 25mOhm;2.66A	DIP	TOKO	8RHB2-#822LY-3R3M
1	L2	1.5 μ H	Inductor;1.5 μ H; 10 mOhm;7A	DIP	Würth	744732015
1	LX1	30mH	Common Inductor; 1.5A;	DIP	Emei	TP4M30-02
1	Q1	SMK0765F	Mosfet;650V;7A	TO-220F-3L	AUK	SMK0765F
0	Q2	NS				
2	R1, R2	150k	Resistor;1%;1W	DIP	Any	
1	R3	20 Ω	Film Resistor; 5%;1/4W	1206	Royalohm	1206J0200T5E
1	R4	0	Resistor;5%	1206	Yageo	RC12065JR-070RL
1	R5	20k	Film Resistor; 5%;1/4W	1206	LIZ	CR1206J40203G
1	R9	51	Resistor; 5%;1/8W;	0805	Yageo	RC0805JR-0751RL
1	R10	20k	Film Resistor; 5%;	0603		653610846CR03T03705NJ20K
1	R11	3.01k	Film Resistor;1%	0603	Yageo	RC0603FR-073K01L
2	R13, R14	1.1	Film Resistor;1%	1206	Yageo	RC1206FR-071R1L
2	R15, R16	51	Film Resistor;1%	1206	Yageo	RC1206FR-0751RL
2	R17, R18	10	Film Resistor; 5%;1/4	1206	Yageo	CR1206JR-0710R
1	R19	1k	Film Resistor;5%	0603		0603SAJ0102T5E
1	R21	43.2k	Film Resistor; 1%;	0603	Yageo	RC0603FR-0743K2L
1	R22	30.1k	Film Resistor; 1%;	0603	Yageo	RC0603FR-0730K1L
1	R24	10k	Film Resistor; 1%;	0603	Yageo	RC0603FR-0710KL
0	R6, R7, R8, R14, R20, R23, R25, R26, R27, R28, R29	NS				



EVHFC0500-S-00A BILL OF MATERIALS (continued)

Qty	Ref	Value	Description	Package	Manufacturer	Part Number
1	RT1	5	Resistor, NTC	DIP	Xingshun	5D2-10
1	RT2	NS				
1	RV1	TVR10431	Varistor	DIP	TKS	TVR10431KSY
1	T1		Transformer;894 μ H; Np:Naux:Ns1:Ns2 =64:10:4:8	ER28	Emei ⁽¹⁾	FX0312
1	U1	HFC0500	Fixed Frequency Flyback Controller with ultra low Power consumption	SOIC8-7A	MPS	HFC0500, R2
1	U2	PC817A	Photocoupler; 1-Channel	DIP	Yiguang	PC817A
1	U3	TLV431	Shunt Regulator, 1.24V	SOT23	Guoda	TLV431ACDBZR

Note:

1. The website is www.emeigroup.com

TRANSFORMER STRUCTURE

Electrical Diagram

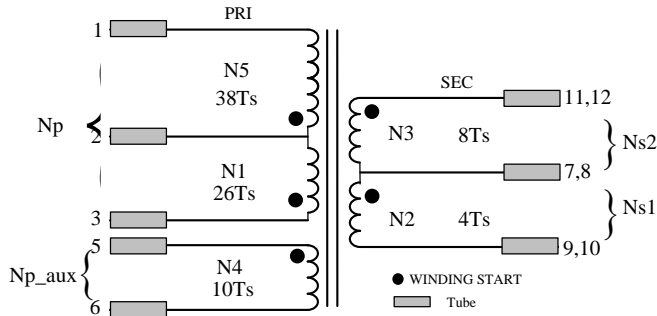

Winding Diagram

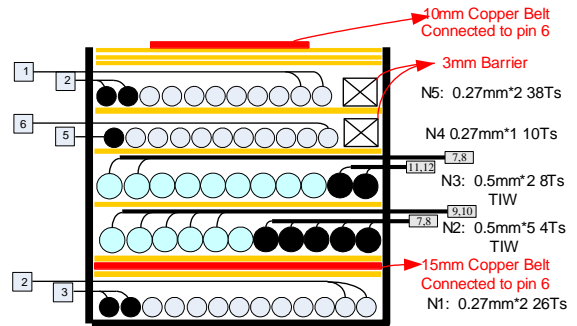

Notes:

1. Round one layer copper outside of the N1. And make sure the head and the tail of the copper and connected, then connected the copper to Ground Pin(Pin6).
2. Round one layer copper outside of the core air gap. And make sure the head and the tail of the copper and connected, then connected the copper to Ground Pin(Pin6).
3. Left 3mm barrier for N4 and N5 turns..

Pin Definition of Bobbin

Pin Out

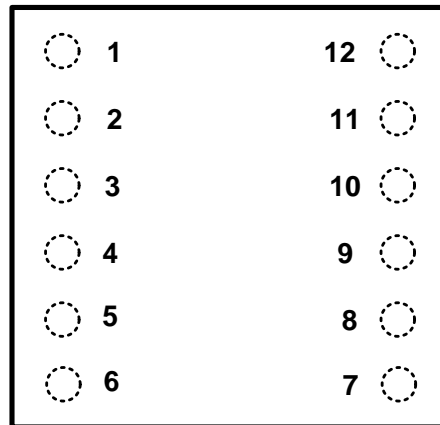

View from the top

Table 1—Electrical Characteristic

Parameter	Condition	Value
Primary Inductance	Lp(1-3)	894uH±5%
Core		EER28
Bobbin		EER28
Core Material		PC40 or equivalent
Turn Ratio	N1:N2:N3:N4:N5	26:4:8:10:38

Table 2—Winding Specification

Tape Turns	Winding No.	Start&End	Wire Diameter (mm)	Turns
1	N1	3→2	0.27×2	26
1	N2	7,8→9,10	0.5×5 TIW	4
1	N3	11,12→7,8	0.5×2 TIW	8
1	N4	5→6	0.27*1	10
3	N5	2→1	0.27×2	38

EV BOARD TEST RESULTS

Efficiency vs. Load Current

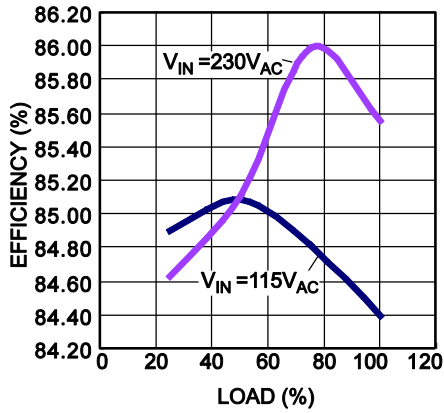

No Load Power Consumption vs. Input Voltage

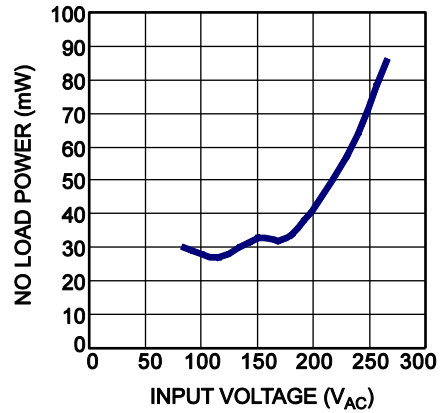

Load Regulation

Load condition		Input Voltage			
		90V _{AC}		265V _{AC}	
5V	16V	5V	16V	5V	16V
0.3A	0.3A	5.03V	15.43V	5.03V	15.42V
0.3A	1.5A	5.03V	15.02V	5.03V	15.02V
3A	0.3A	5.01V	16.75V	5.01V	16.69V
3A	1.5A	5.01V	15.96V	5.01V	15.76V

EVB TEST RESULTS

Performance waveforms are tested on the evaluation board.

$V_{IN} = 265V_{AC}$, $V_{OUT1} = 5V$, $V_{OUT2} = 16V$, full load, $T_A = 25^{\circ}C$, unless otherwise noted.

Stress
Steady State, Mosfet

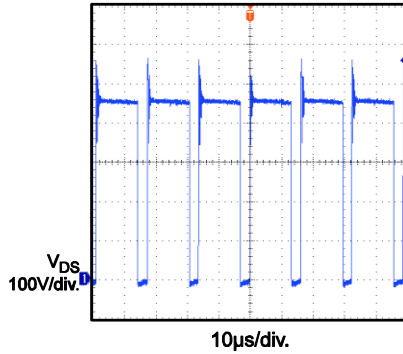

Stress
Steady State,
Output 1 Diode

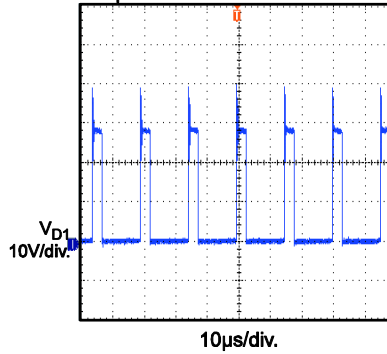

Stress
Steady State,
Output 2 Diode

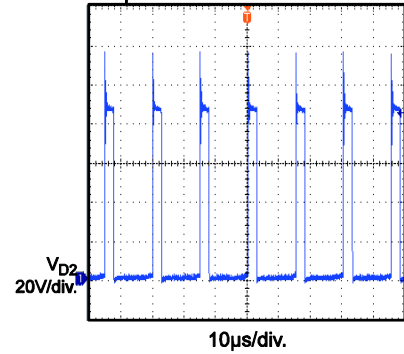

Stress
OVP, Mosfet

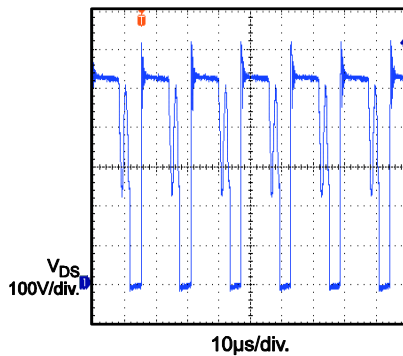

Stress
OVP, Output 1 Diode

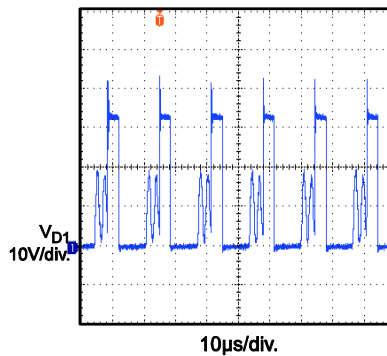

Stress
OVP, Output 1 Diode

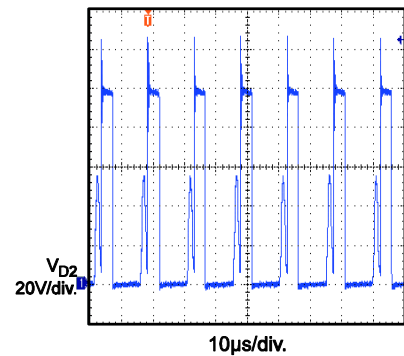

SCP
 $V_{IN}=90V_{AC}$

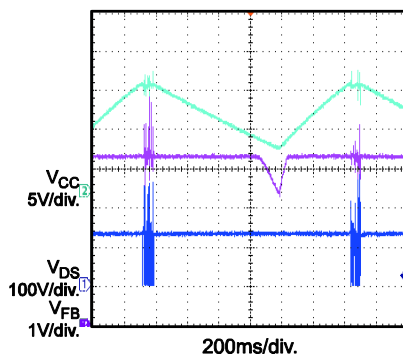

SCP
 $V_{IN}=230V_{AC}$

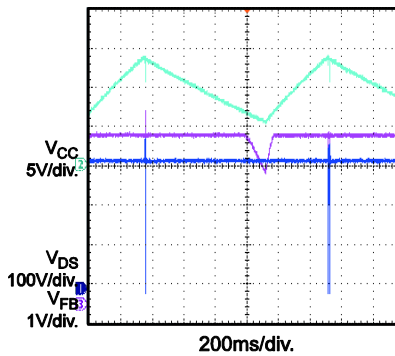

OVP
 $V_{IN}=90V_{AC}$

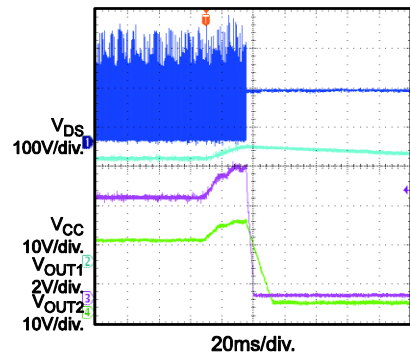

EVB TEST RESULTS *(continued)*

Performance waveforms are tested on the evaluation board.

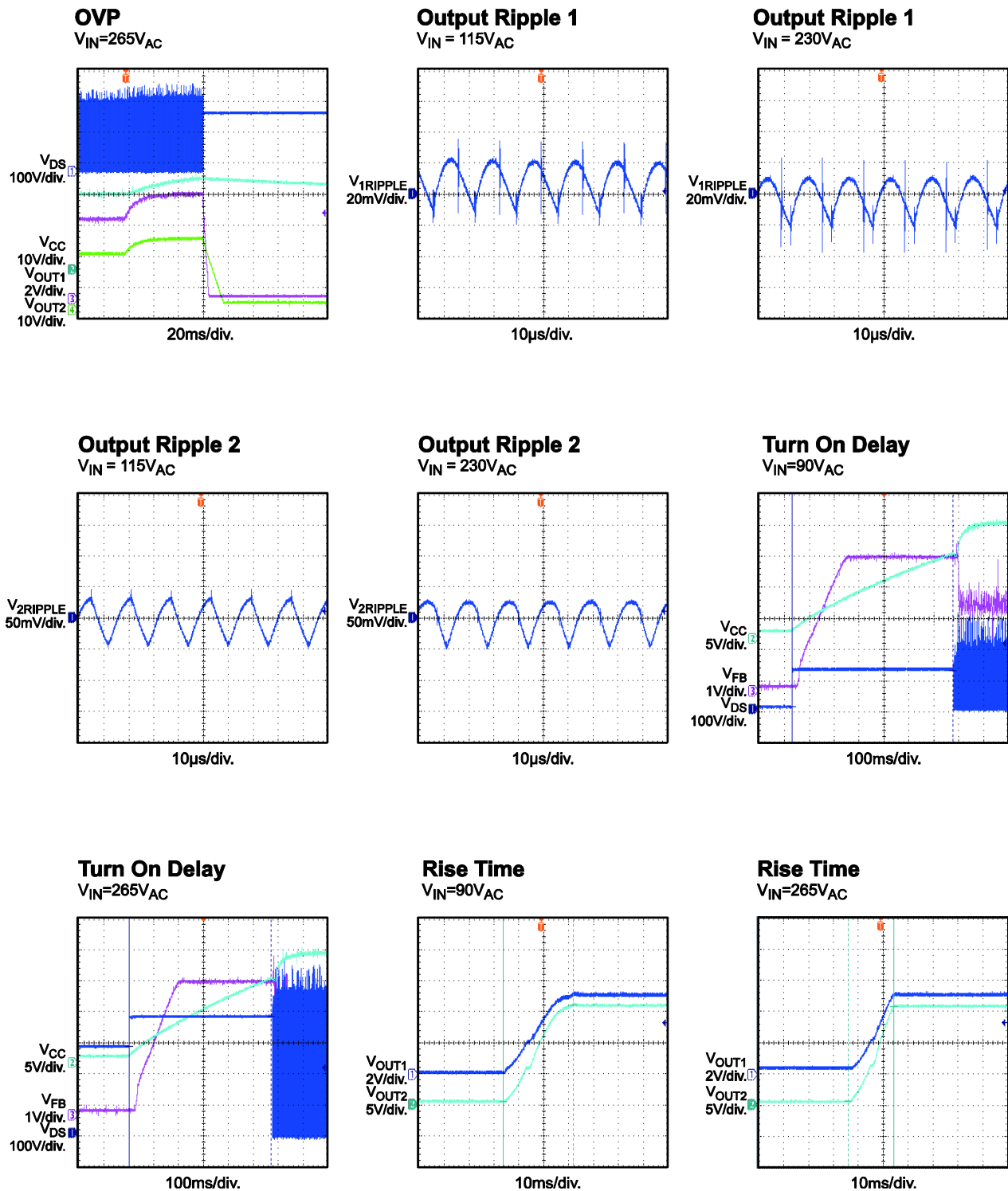
 $V_{OUT1} = 5V$, $V_{OUT2} = 16V$, full load, $T_A = 25^\circ C$, unless otherwise noted.

EVB TEST RESULTS (continued)

Performance waveforms are tested on the evaluation board.

$V_{OUT1} = 5V$, $V_{OUT2} = 16V$, full load, $T_A = 25^\circ C$, unless otherwise noted.

Start Up
 $V_{IN}=115V_{AC}$

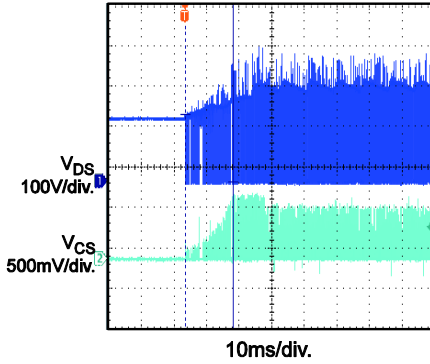

Start Up
 $V_{IN}=230V_{AC}$

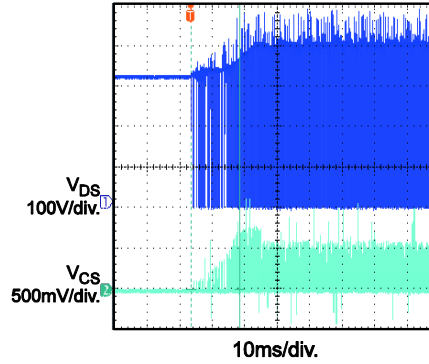

EMI
Three Line, 110V, L

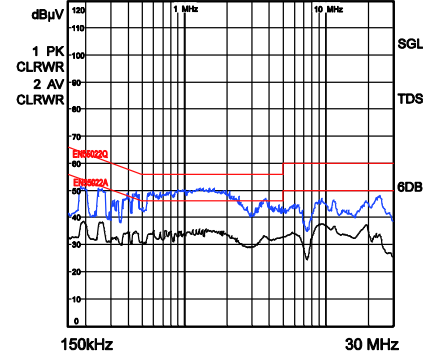

EMI
Three Line, 110V, N

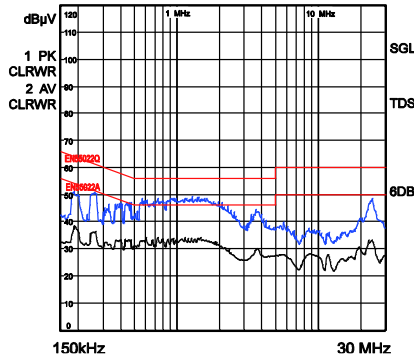

EMI
Three Line, 230V, L

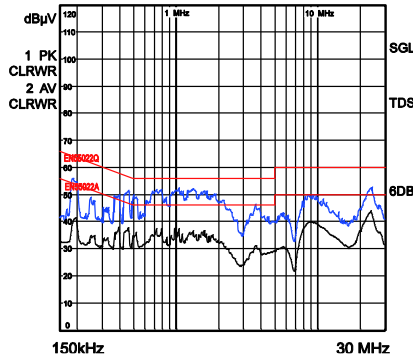

EMI
Three Line, 230V, N

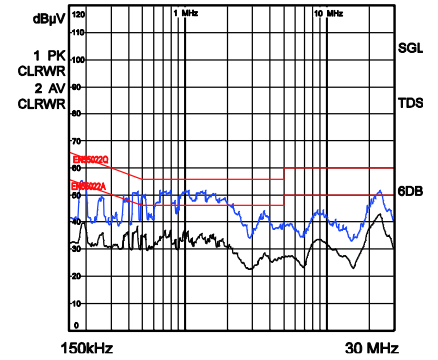

PRINTED CIRCUIT BOARD LAYOUT

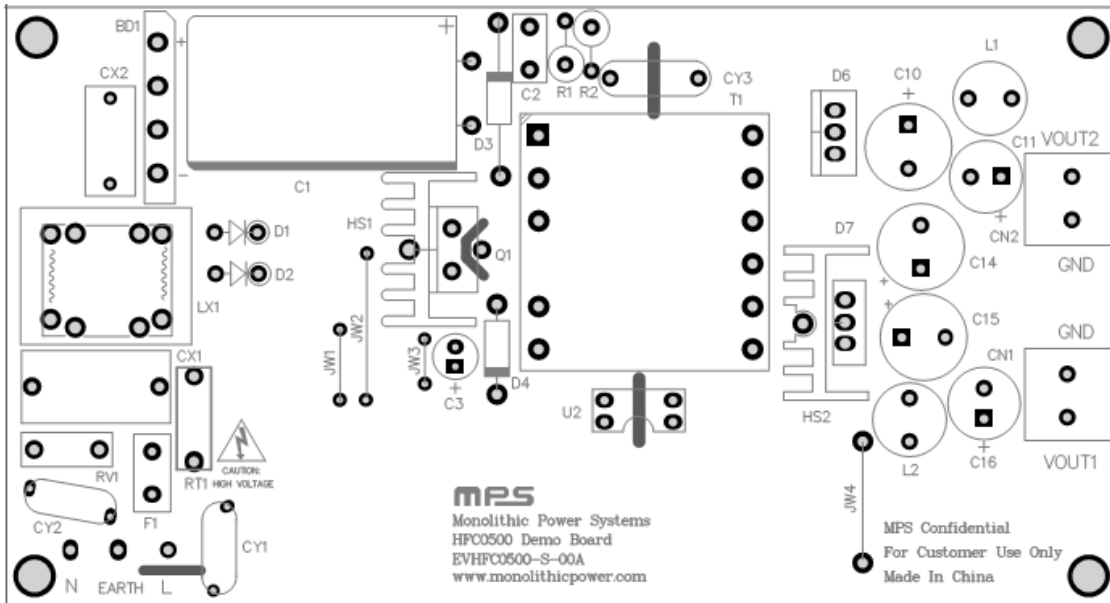

Figure 1 — Top Layer

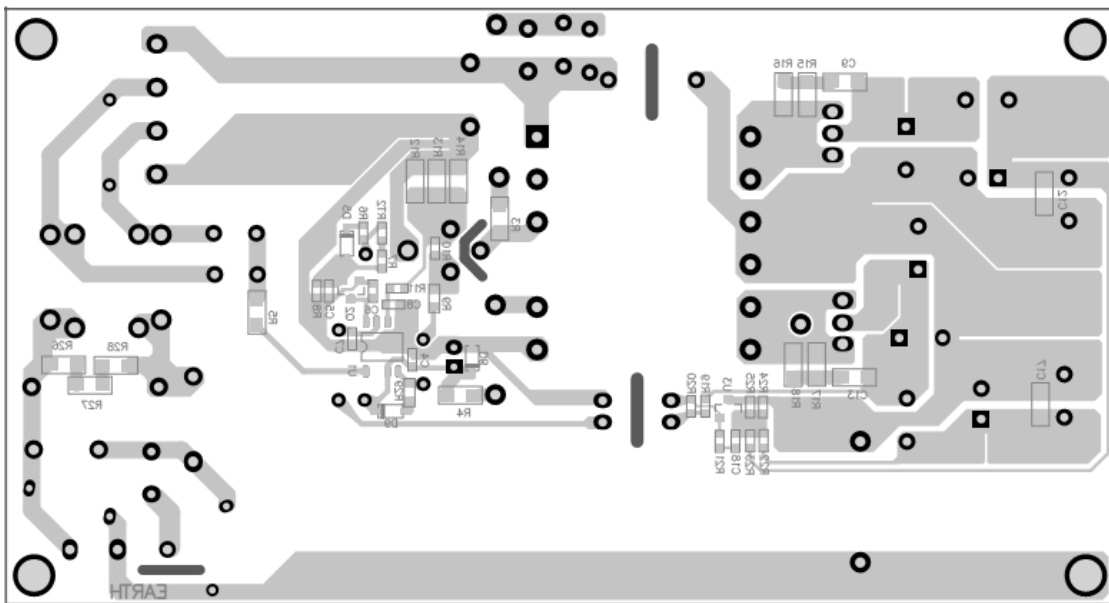

Figure 2 — Bottom Layer

QUICK START GUIDE

1. Preset Power Supply to $90V \leq V_{AC} \leq 265V$.
2. Turn Power Supply off.
3. Connect the power supply output to L and N pins respectively.
4. Connect the positive and negative terminals of the Load to VOUT and GND pins respectively.
5. Turn Power Supply on after making connections.

Contact Information

To request this evaluation board, please refer to your local sales offices which can be found from:

<http://www.monolithicpower.com/Company/Contact-Us>

Disclaimer

Monolithic Power Systems (MPS) reserves the right to make changes to its products and to discontinue products without notice. The applications information, schematic diagrams, and other reference information included herein is provided as a design aid only and are therefore provided as-is. MPS makes no warranties with respect to this information and disclaims any implied warranties of merchantability or non-infringement of third-party intellectual property rights.

MPS cannot assume responsibility for use of any circuitry other than circuitry entirely embodied in a MPS product. No circuit patent licenses are implied.

Certain applications using semiconductor products may involve potential risks of death, personal injury, or severe property or environmental damage (“Critical Applications”).

MPS PRODUCTS ARE NOT DESIGNED, INTENDED, AUTHORIZED, OR WARRANTED TO BE SUITABLE FOR USE IN LIFE-SUPPORT APPLICATIONS, DEVICES OR SYSTEMS, OR OTHER CRITICALAPPLICATIONS.

Inclusion of MPS products in critical applications is understood to be fully at the risk of the customer. Questions concerning potential risk applications should be directed to MPS.

MPS semiconductors are typically used in power supplies in which high voltages are present during operation. High voltage safety precautions should be observed in design and operation to minimize the chance of injury.

NOTICE: The information in this document is subject to change without notice. Please contact MPS for current specifications. Users should warrant and guarantee that third party Intellectual Property rights are not infringed upon when integrating MPS products into any application. MPS will not assume any legal responsibility for any said applications.