

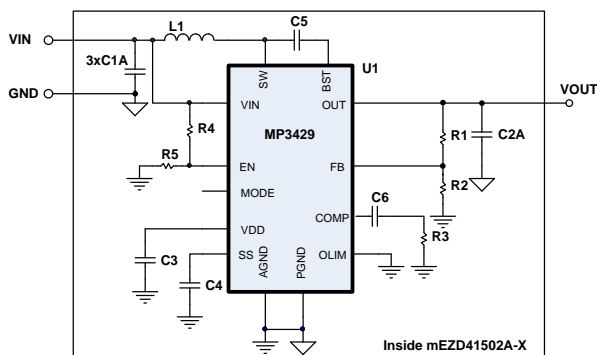

mEZ Product Options:

1. Ready-to-Use products
 2. Do-It-Yourself.
- Manufacture assistance is provided



Block Diagram

FEATURES

- Up to 13V Input Voltage
- 5V, 12V, 15V Output Options
- 2A Continuous Output Current
- Open Design Files and BOM
- 600kHz Fixed Frequency
- High Efficiency
- Over-Temperature Protection

ORDERING INFORMATION

Part Number	Input Voltage (V)	Output Voltage (V)	Output Current (A)
MEZD41502A-A	2.7 - 4.2	5	2
MEZD41502A-B	2.7 - 10	12	2
MEZD41502A-C	3.4 - 13	15	2

mEZD4150xA-X FAMILY PRODUCTS

Part Number	Input Voltage (V)	Output Voltage (V)	Output Current (A)
mEZD41501A-X	2.7 - 13	5, 12, 15	1
mEZD41502A-X	2.7 - 13	5, 12, 15	2
mEZD41503A-X	2.7 - 10	5, 12	3

ELECTRICAL CHARACTERISTICS

Input Voltage Range	mEZD41502A-A	2.7V to 4.2V
	mEZD41502A-B	2.7V to 10V
	mEZD41502A-C	3.4V to 13V
Output Voltage Set Accuracy		±2.2%
Output Voltage Ripple	$V_{IN} = 3.3V, V_{OUT} = 5V, I_{OUT} = 2A$	27mV (Typ.)
	$V_{IN} = 6.6V, V_{OUT} = 12V, I_{OUT} = 1A$	60mV (Typ.)
	$V_{IN} = 6.6V, V_{OUT} = 15V, I_{OUT} = 1A$	90mV (Typ.)
Line Regulation	V_{IN} from MIN to MAX, $I_{OUT} = 1A$	±0.3%
Load Regulation	I_{OUT} from MIN to MAX, $V_{IN} = 6.6V$	±0.5%
	$V_{IN} = 3.3V, V_{OUT} = 5V, I_{OUT} = 2A$	97.2%
Efficiency	$V_{IN} = 6.6V, V_{OUT} = 12V, I_{OUT} = 2A$	97.4%
	$V_{IN} = 6.6V, V_{OUT} = 15V, I_{OUT} = 2A$	96.7%
Switching Frequency	Typical switching frequency	600kHz
Short-Circuit Protection	No output short allowed	-
Operating Temperature Range		0 to 85°C
Over-Temperature Protection	OTP	150°C
Calculated MTBF	MIL-HDBK-217F	4185x10 ³ hrs

TYPICAL PERFORMANCE CURVES

Power Derating
 $V_{IN} = 3.3V$ and $4.2V$, $V_{OUT} = 5V$

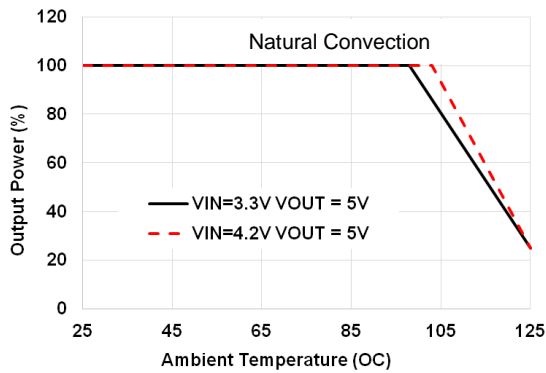

Efficiency vs. Load Current
 $V_{IN} = 3.3V$ and $4.2V$, $V_{OUT} = 5V$

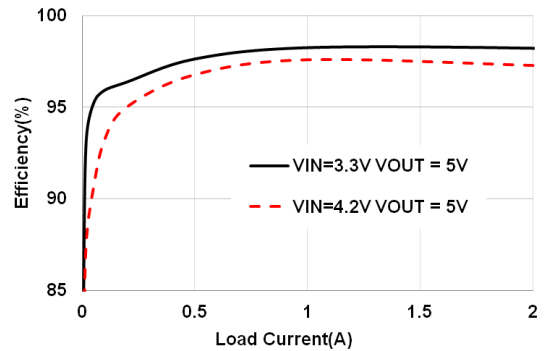

Power Derating
 $V_{IN} = 4.2V$, $6.6V$, and $8.4V$, $V_{OUT} = 12V$

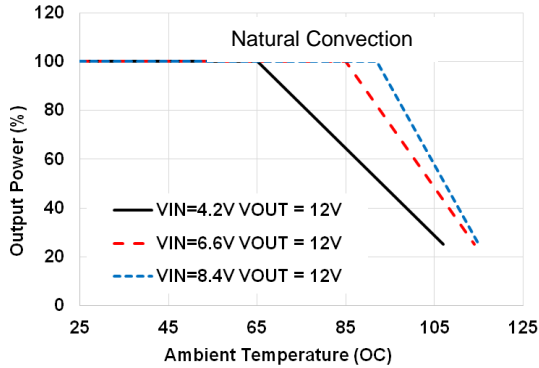

Efficiency vs. Load Current
 $V_{IN} = 4.2V$, $6.6V$, and $8.4V$, $V_{OUT} = 12V$

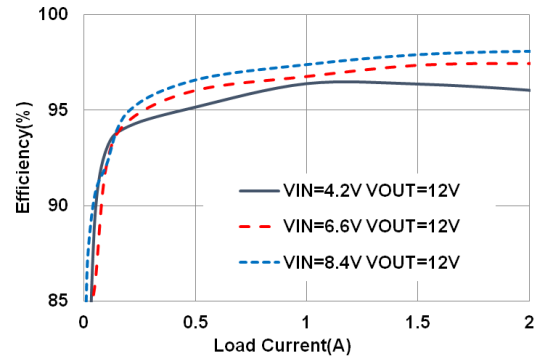

Power Derating
 $V_{IN} = 4.2V$, $6.6V$ and $8.4V$, $V_{OUT} = 15V$

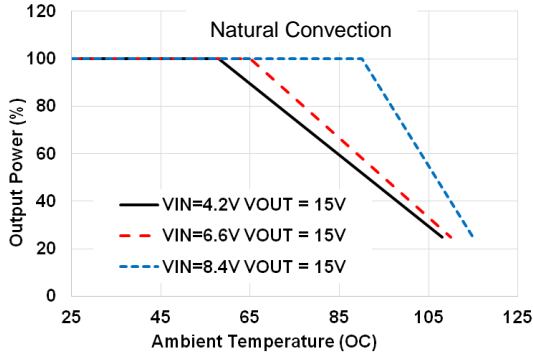

Efficiency vs. Load Current
 $V_{IN} = 4.2V$, $6.6V$ and $8.4V$, $V_{OUT} = 15V$

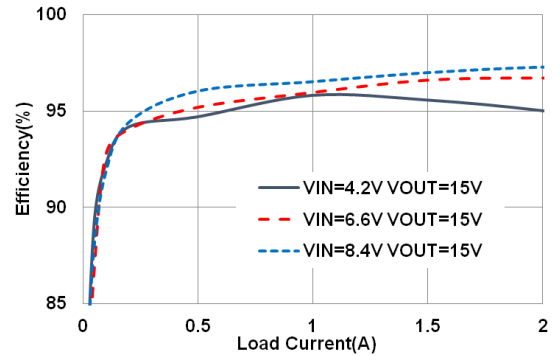

DO-IT-YOURSELF SCHEMATIC



BILL OF MATERIALS

Item	Qty	RefDes	Value	Description	Package	Manufacturer	Manufacturer P/N
1	3	C1A, C1B, C1C	22µF	Ceramic Cap., 10V, X7R (A)	1206	Murata	GRM31CR71A226ME15L
				Ceramic Cap., 25V, X7R (B,C)	1206	Murata	GRM31ER71E226KE15L
2	3	C2A, C2B, C2C	22µF	Ceramic Cap., 10V, X7R (A)	1210	Murata	GRM32ER71A226KE20L
				Ceramic Cap., 25V, X7R (B,C)	1210	Murata	GRM32ER71E226KE15L
3	2	C2D, C5	100nF	Ceramic Cap., 25V, X7R	0603	Murata	GRM188R71E104KA01D
6	1	C3	4.7µF	Ceramic Cap., 6.3V, X5R	0603	Murata	GRM188R60J475KE19D
5	1	C4	22nF	Ceramic Cap., 25V, X7R	0603	Murata	GRM188R71E223JA01D
7	1	C6	8.2nF(A)	Ceramic Cap., 50V, X7R	0603	Murata	GRM188R71H822KA01D
			6.8nF(B,C)				GRM188R71H682KA01D
8	1	R1	750kΩ	Film Res, 1%	0603	YAGEO	RC0603FR-07750KL
			187kΩ(A)				RC0603FR-07187KL
9	1	R2	68kΩ(B)	Film Res, 1%	0603	YAGEO	RC0603FR-0768KL
			53.6kΩ(C)				RC0603FR-0753K6L
10	1	R3	3kΩ(A)	Film Res, 1%	0603	YAGEO	RC0603FR-073KL
			10kΩ(B,C)				RC0603FR-0710KL
11	1	R4	30kΩ	Film Res, 1%	0603	YAGEO	RC0603FR-0730KL
12	1	R5	34.8kΩ	Film Res, 1%	0603	YAGEO	RC0603FR-0734K8L
13	0	R6, R7	NC				
14	1	L1*	1.5µH	Irms = 19A, RDC = 3.3mΩ	11.5x10mm	Sumida	104CDMCCDS-1R5MC-ND
15	0	S1	NC				
16	1	U1	MP3429	Boost Converter	QFN 3x4mm	MPS	MP3429GL
17	1	VIN,VOUT,GND	Connector	6-Pin Connector	2.54mm	Würth	

NOTE: A, B, C denote this value is specifically for mEZD41502A-A, mEZD41502A-B, mEZD41502A-C respectively.

* Or equivalent

PRODUCT PACKAGE AND DIMENSIONS

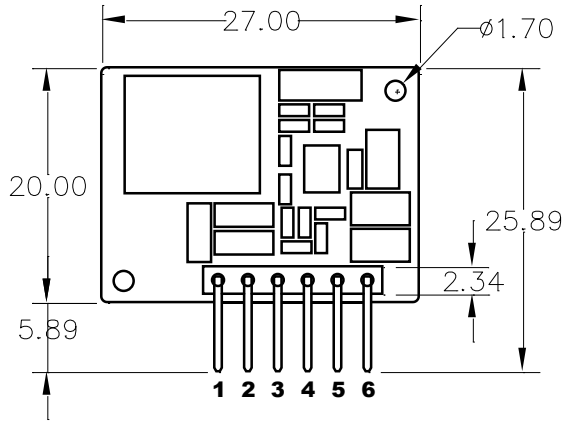

TOP VIEW

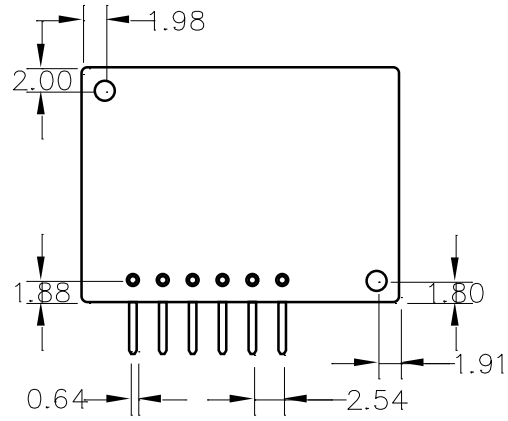

BOTTOM VIEW

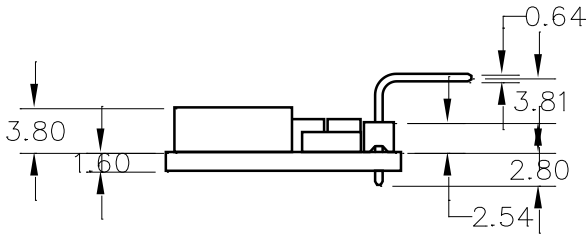

SIDE VIEW

Pin	Designation	Function
1, 2	VIN	Input Voltage
3, 4	GND	Power Ground
5, 6	VOUT	Output Voltage

NOTE:

Contact factory for different sizes of the boards (Quantity >2k).

For more information, Gerber files, and PCB layout, please contact mEZsupport@monolithicpower.com