

## DESCRIPTION

The MPQ2489 is a high efficiency step-down converter designed in continuous current mode for driving the high brightness Light Emitting Diodes (LED) from wide input voltage 6V–55V.

The MPQ2489 employs hysteretic control architecture to regulate a high accuracy LED current, which is measured through an external high-side current sensing resistor. Moreover, this control scheme provides optimized circuit stabilization and very quick response time without the loop compensation. Its low 202mV average feedback voltage reduces power loss and improves the converter efficiency.

The MPQ2489 implements PWM and analog dimming together with DIM pin.

The MPQ2489 includes thermal overload protection preventing damage in the event of an output overload.

The MPQ2489 is available in small QFN6 (3x 3mm) package.

## FEATURES

- Guaranteed Industrial/Automotive Temp
- Internal 60V MOSFET
- Wide 6V to 55V Input Range
- $\geq 1A$  Output Current
- High Efficiency (>95%)
- Hysteresis Control
- PWM & Analog Dimming
- 1000:1 PWM Dimming Resolution
- Thermal Shutdown
- Inherent Open LED Protection
- Short LED Protection
- Available in QFN6(3x 3mm) Package
- Available in AEC-Q100 Grade 1

## APPLICATIONS

- Low Voltage Halogen Replacement
- Low Voltage General Illumination
- Automotive/Decorative LED Lighting
- Signs/Emergency Lighting
- LED Backlighting

All MPS parts are lead-free and adhere to the RoHS directive. For MPS green status, please visit MPS website under Products, Quality Assurance page. "MPS" and "The Future of Analog IC Technology" are registered trademarks of Monolithic Power Systems, Inc.

## TYPICAL APPLICATION

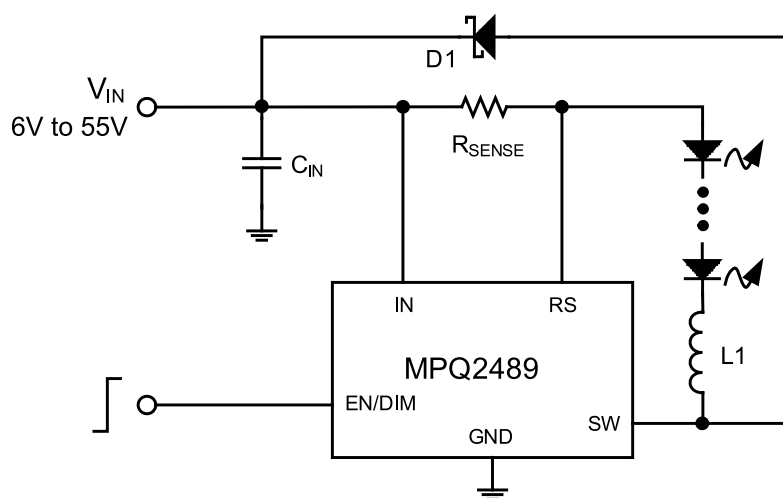

### ORDERING INFORMATION

Part Number	Package	Top Marking
MPQ2489DQ*	QFN-6 (3x3mm)	9Y
MPQ2489DQ-AEC1**	QFN-6 (3x3mm)	9Y

\* For Tape & Reel, add suffix -Z (e.g. MPQ2489DQ-Z).

For RoHS Compliant Packaging, add suffix -LF (e.g. MPQ2489DQ-LF-Z)

\*\* For Tape & Reel, add suffix -Z (e.g. MPQ2489DQ-AEC1-Z).

For RoHS Compliant Packaging, add suffix -LF (e.g. MPQ2489DQ-AEC1-LF-Z)

### PACKAGE REFERENCE

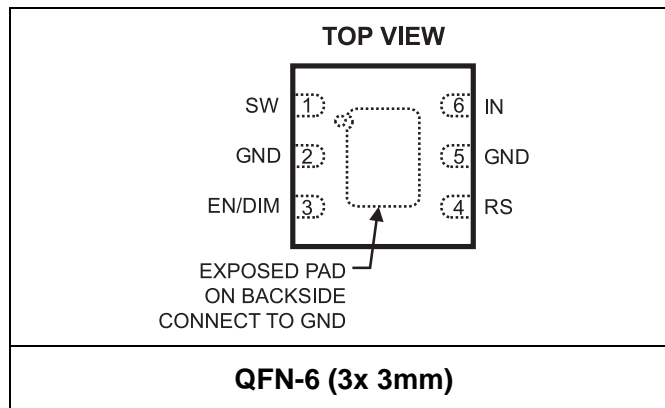

#### ABSOLUTE MAXIMUM RATINGS <sup>(1)</sup>

$V_{IN}, V_{SW}$ .....	-0.3V to +60V
$V_{RS}$ .....	$V_{IN}-5V$ to $V_{IN}$
All Other Pins .....	-0.3V to +6.3V
Continuous Power Dissipation ( $T_A = +25^\circ C$ ) <sup>(2)</sup>	
QFN6 .....	2.5W
Junction Temperature .....	150°C
Lead Temperature .....	260°C
Storage Temperature .....	-65°C to +150°C

#### Recommended Operating Conditions <sup>(3)</sup>

Supply Voltage $V_{IN}$ .....	6V to 55V
Operating Junction Temp. ( $T_J$ ) .....	-40°C to +125°C

#### Thermal Resistance <sup>(4)</sup>

	$\theta_{JA}$	$\theta_{JC}$
QFN-6 (3mm x 3mm) .....	50	14... °C/W

#### Notes:

- 1) Exceeding these ratings may damage the device.
- 2) The maximum allowable power dissipation is a function of the maximum junction temperature  $T_J(MAX)$ , the junction-to-ambient thermal resistance  $\theta_{JA}$ , and the ambient temperature  $T_A$ . The maximum allowable continuous power dissipation at any ambient temperature is calculated by  $P_D(MAX) = (T_J(MAX) - T_A) / \theta_{JA}$ . Exceeding the maximum allowable power dissipation will cause excessive die temperature, and the regulator will go into thermal shutdown. Internal thermal shutdown circuitry protects the device from permanent damage.
- 3) The device is not guaranteed to function outside of its operation conditions.
- 4) Measured on JESD51-7, 4-layer PCB.

**ELECTRICAL CHARACTERISTICS** **$V_{IN} = 24V$ ,  $T_J = -40^{\circ}C$  to  $+125^{\circ}C$  unless otherwise noted. Typical values are at  $T_J = 25^{\circ}C$ .**

Parameter	Symbol	Condition	Min	Typ	Max	Units	
Input Voltage	$V_{IN}$		6		55	V	
Shutdown Supply Current	$I_{SD}$	$V_{IN} = 24V$	$T_J = 25^{\circ}C$	85	108	$\mu A$	
			$T_J = -40^{\circ}C$ to $+125^{\circ}C$		130		
Quiescent Supply Current	$I_Q$	No Switching			1	mA	
Internal Reference Voltage	$V_{REF}$		1.23	1.275	1.32	V	
Feedback Reference Voltage (with respect to $V_{IN}$ )	$V_{IN}-V_{RS}$	$V_{EN/DIM} = 1.28V$	$T_J = 25^{\circ}C$	192	202	212	mV
			$T_J = -40^{\circ}C$ to $+125^{\circ}C$	187		217	
Feedback Reference Voltage Hysteresis	$V_{FB\_HYS}$			$\pm 30$		mV	
EN/DIM Max Dimming Voltage	$V_{DIM\_MAX}$				2.56	V	
EN/DIM Min Dimming Voltage	$V_{DIM\_MIN}$		0.3			V	
EN/DIM Enable High Voltage	$V_{EN\_HIGH}$	$V_{EN}$ Rising			0.3	V	
EN/DIM Enable Low Voltage	$V_{EN\_LOW}$	$V_{EN}$ Falling	0.16			V	
EN/DIM Up-pulling Resistor	$R_{EN}$			45		k $\Omega$	
Recommended PWM Dimming Frequency <sup>(5)</sup>	$F_{PWM}$		0.1		2	kHz	
Switch On Resistance	$R_{DS\_ON}$			0.5		$\Omega$	
Minimum On Time <sup>(6)</sup>	$T_{ON\_MIN}$			100		ns	
Minimum Off Time <sup>(6)</sup>	$T_{OFF\_MIN}$			100		ns	
Recommended Maximum Operating Frequency	$F_{MAX}$				600	kHz	
Recommended Duty Cycle Range at $F_{MAX}$ <sup>(5)</sup>	D		30		70	%	
Start Up Time	$T_{SS}$	External capacitor on dim pin is 4.7nF		0.3	0.5	ms	

**Notes:**

- 5) Application recommendation, no production test.  
6) Design Guarantee, no production test.



## PIN FUNCTIONS

QFN6 Pin#	Name	Description
1	SW	The Drain of Internal MOSFET. Connecting the common terminal of inductor and anode of Schottky to this pin.
2, 5	GND	Ground.
3	EN/DIM	Enable/Dimming Command Input. To use PWM dimming, apply a square wave signal to this pin. To use Analog dimming, apply a 0.3V–2.5V DC voltage to this pin. The voltage from 0.3V to 2.5V linearly controls the LED current range from 25% to 200%. Turn off the output current when pulling this pin below 0.2V. Connect a 1nF–10nF capacitor for normal operation ( $V_{EN/DIM}=1.28V$ ).
4	RS	LED Current Sense Input. Connecting the current sensing resistor that programs the LED average current to IN pin.
6	IN	Input Supply Pin. Connecting a proper decoupling capacitor from IN pin to GND.

## TYPICAL PERFORMANCE CHARACTERISTICS

$V_{IN}=30V$ , 3 LEDs in series,  $I_{OUT}=550mA$ , unless otherwise noted.

$I_Q$  Current vs.  $T_J$

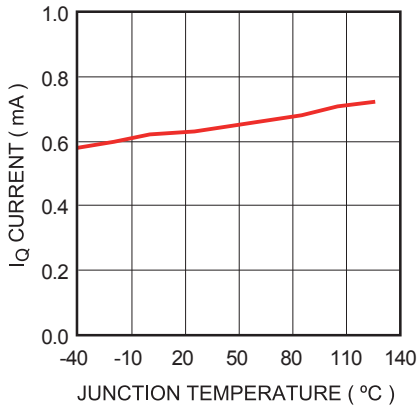

$V_{RS}$  Reference vs.  $T_J$

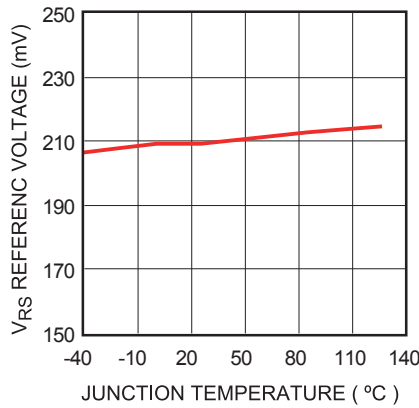

Reference Voltage vs.  $T_J$

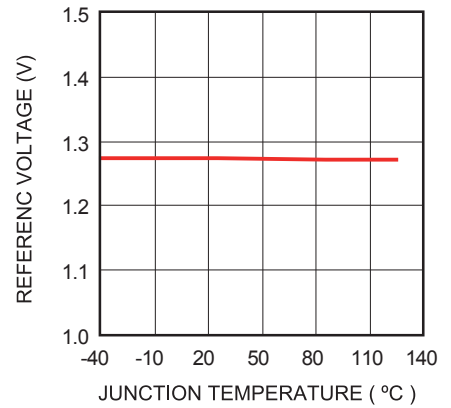

Enable ON/OFF Voltage vs.  $T_J$

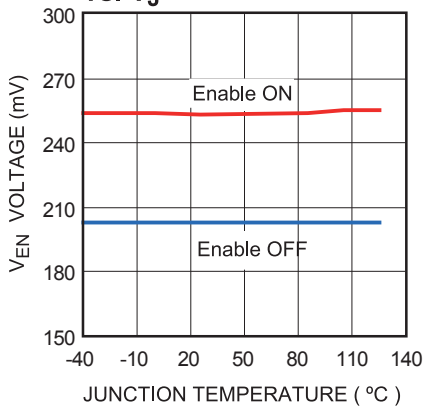

$F_{SW}$  vs.  $T_J$

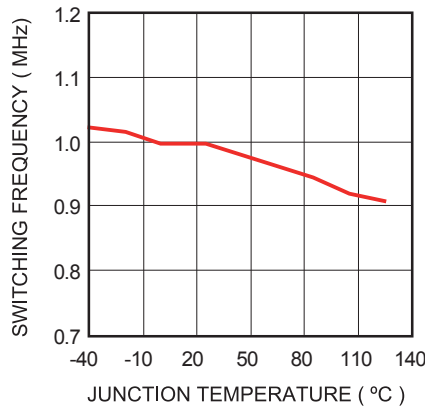

$I_{OUT}$  Line Regulation

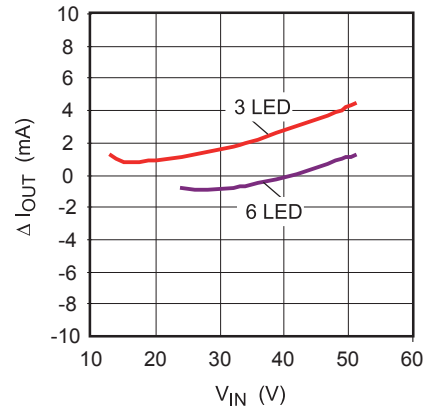

Efficiency vs. Input Voltage

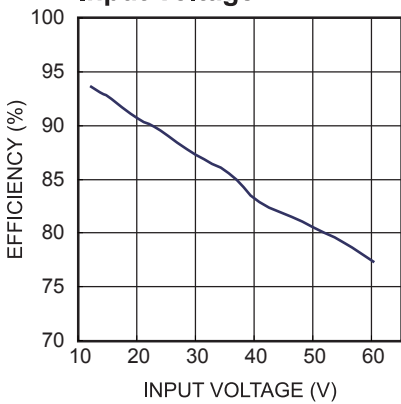

Analog Dimming Curve

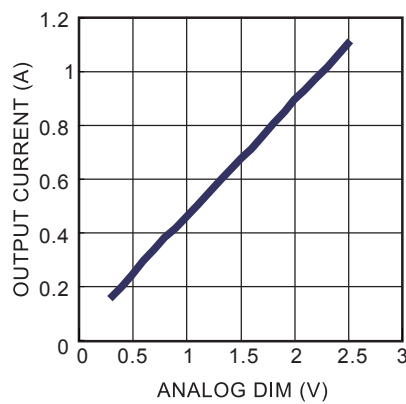

$I_{LED}$  vs.  $R_{set}$

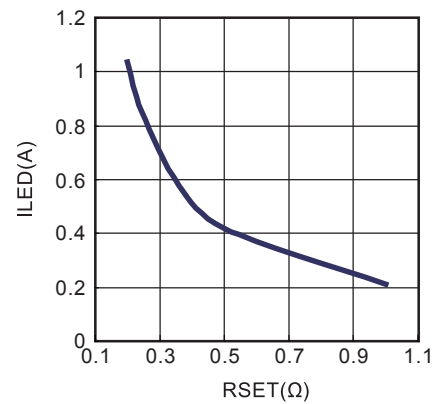

## TYPICAL PERFORMANCE CHARACTERISTICS (CONTINUED)

$V_{IN}=30V$ , 3 LEDs in series,  $I_{OUT}=550mA$ , unless otherwise noted.

**Steady State**

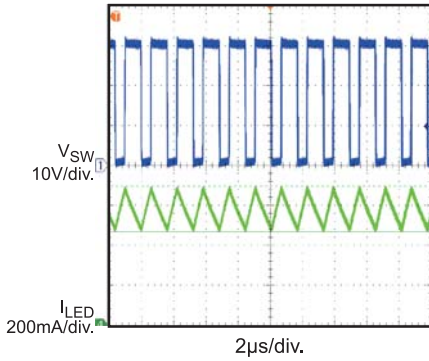

**Vin Startup**

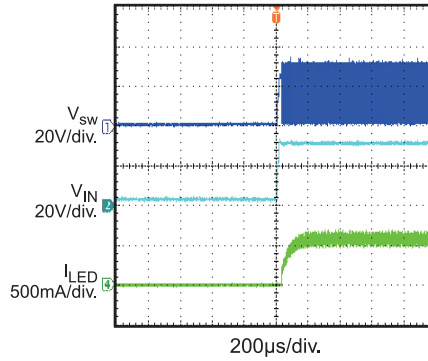

**Ven Startup**

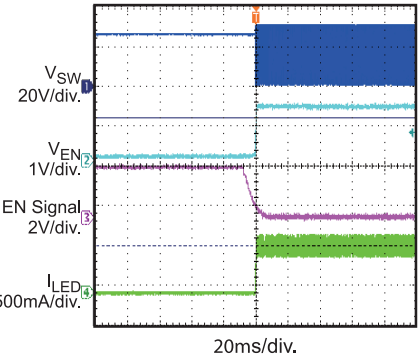

**PWM Dimming**

$f_{PWM} = 200Hz$ ,  $D_{PWM} = 50\%$

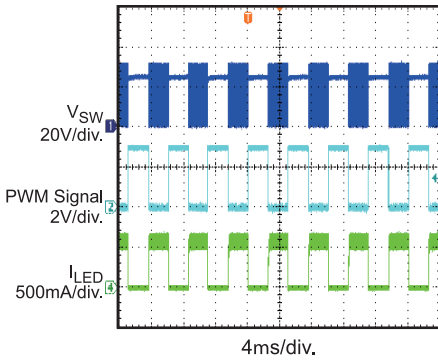

**Open LED Protection**

Open LEDs at working

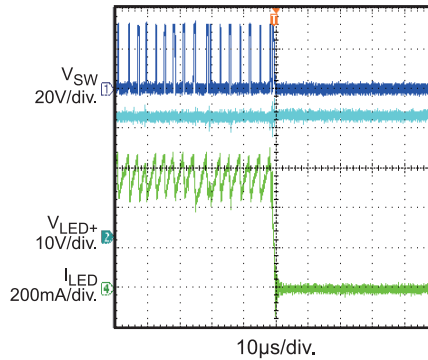

**Short LED Protection**

Short LEDs at working

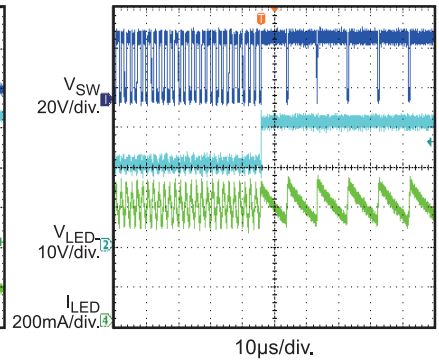

**Analog Dimming**

$V_{ADIM} = 1.28V$ ,  $I_{OUT}=527mA$ ,  $V_{IN}=51V$

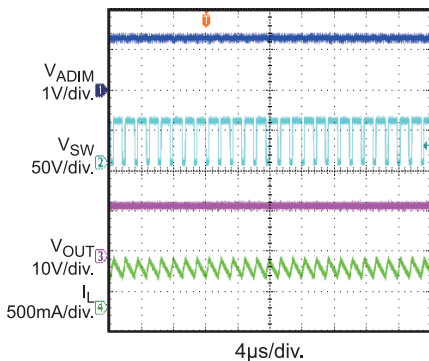

**PWM Dimming Curve**

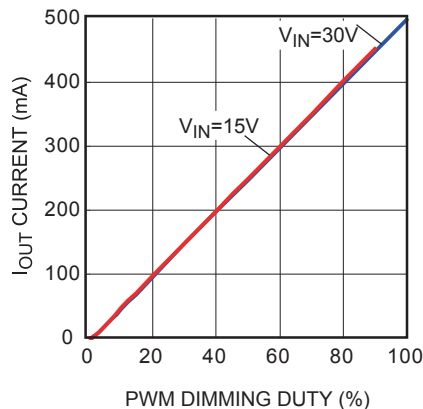

### FUNCTION DIAGRAM

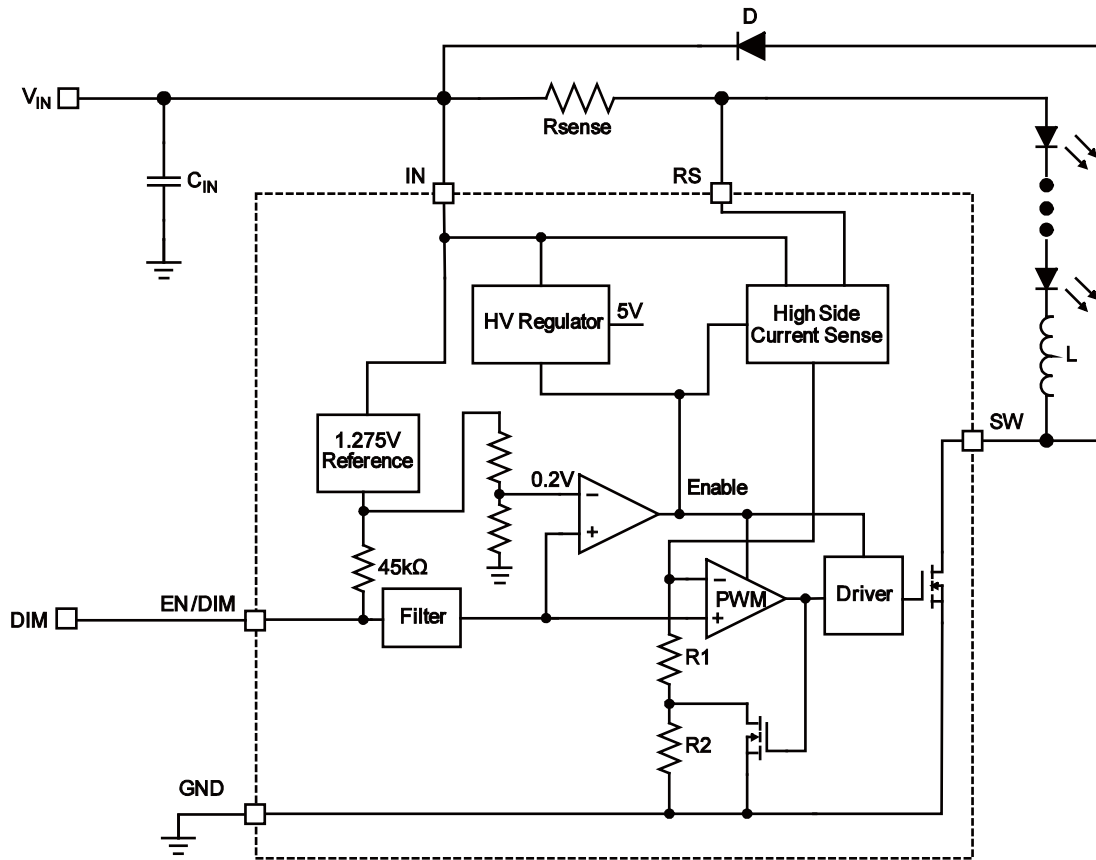

Figure 1—MPQ2489 Function Block Diagram

## OPERATION

### Steady State

The MPQ2489 is a hysteretic controlled step down LED driver that is easily to be configured in varies applications ranging from 6V–55V input. The converter employs a high side current sensing resistor to detect and regulate the LED current. The voltage across the current sensing resistor is kept measured and regulated in 202mV±30mV range.

The internal 1.275V reference voltage is utilized to provide a 0.2V reference for enabling the part and a 1.275V pulling-up voltage as current reference voltage. When  $V_{EN} > 0.2V$ , the output of the comparator becomes high and the other blocks are enabled.

Output current is sensed by high-side resistor  $R_{sense}$ . When the switch is on,  $R_2$  is shorted and output current upper-threshold is fixed by  $R_1$ . When the switch is off, output current lower-threshold is fixed by  $R_1$  and  $R_2$ . Ratio of  $R_1$  and  $R_2$  determines the current hysteresis.

### Enable Control

Once Input voltage is applied, the internal 1.275V reference is connected to EN/DIM pin through pull up resistor. If EN/DIM is left open, the IC will automatically start up to the maxim brightness. Applying a capacitor on this pin can hereby program a soft start time.

If an external voltage range from 1.275V to 1.25V is applied to this pin, the current sensing voltage reference is linearly controlled from 0mV to 202mV. By controlling the EN/DIM pin voltage the analog dimming can be easily employed.

If an external PWM voltage is applied on this pin, the IC will follow the PWM duty to achieve the PWM dimming, the PWM signal amplitude must be about 1.25V. About the flexible external PWM dimming method, please refer to the selecting dimming control mode section.

### System Soft Start

The voltage on the EN/DIM pin is the inductor current reference. An external capacitor from the EN/DIM pin to ground provides a soft-start delay. When  $V_{IN}$  starts, internal voltage source charges the capacitor from 0V to 1.25V to fulfill soft-start function.

### Dimming Control

MPQ2489 provides two dimming methods: PWM dimming and DC analog dimming.

To use PWM dimming, apply a square wave to the EN/DIM pin. To use analog dimming, apply a 0.3V–2.5V DC voltage to this pin.

### Maximum Continuous Switching Current

MPQ2489 max continuous switching current depends on the package with different thermal resistance. The table 1 shows the max continuous current corresponding package for reference.

**Table 1.  $I_{MAX}$  vs. Package**

<b>Package</b>	QFN6
<b><math>I_{max}(A)</math></b>	1.41



## APPLICATION INFORMATION

### Setting the LED Current

The LED current is identical and set by the current setting resistor between the IN pin and RS pin.

$$R_{SET} = 202mV / I_{LED}$$

For  $R_{SET} = 0.36\Omega$ , the LED current is set to 550mA

### Selecting the Diode

The output diode supplies current to the inductor when the internal MOSFET is off. To reduce losses due to diode forward voltage and recovery time, use a Schottky diode with the MPQ2489. The diode should be rated for a reverse voltage greater than the input voltage. The average current rating must be greater than the maximum load current expected, and the peak current rating must be greater than the peak inductor current.

### Selecting the Input Capacitor

The input capacitor reduces the surge current drawn from the input supply and the switching noise from the device. A  $10\mu F$ – $22\mu F$  capacitor is enough for most application. The voltage rating should be greater than input voltage. A low ESR capacitor should be used for input decoupling.

### Selecting the Output Capacitor

For most applications, output capacitor is not necessary. But if peak to peak ripple LED current is required less than 30% of average current, add a capacitor across the LEDs. Proportionally lower ripple can be achieved with higher capacitor value. A value of  $2.2\mu F$  will meet most requirements.

### Selecting Soft-Start Capacitor

With the soft-start capacitor, the delay time can be estimated by  $0.2ms/nF$ . In PWM dimming,  $C < 2.2nF$  is recommended to eliminate its effect on LED average current.

### Selecting Dimming Control Mode

MPQ2489 provides two dimming methods: DC analog dimming and PWM dimming.

#### 1. DC analog dimming mode

Apply a 0.3V–2.5V DC voltage to the EN/DIM pin. The voltage from 0.3V to 2.5V changes the

inductor current reference directly and linearly controls the inductor current range from 25% to 200%. (See Figure 2)

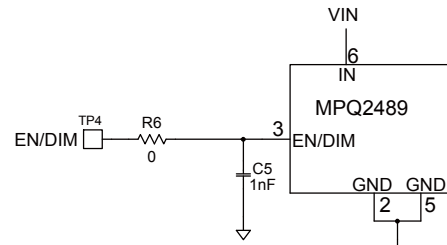

**Figure 2—Analog Dimming External Circuit**

#### 2. PWM dimming mode

Apply a 100Hz to 2kHz square waveform to the EN/DIM pin. The average LED current is proportional to PWM duty. Because this pin is pulled up by 1.25V internal source as inductor current reference, a NPN-transistor on/off circuit is recommended to separate PWM signal from the current reference. (See Figure 3). The minimum amplitude of the PWM signal is 1.5V.

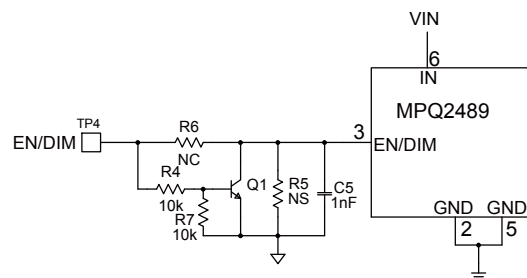

**Figure 3—PWM Dimming External Circuit**

### Selecting the Inductor

Lower value of inductance can result in higher switch frequency, which causes larger switch loss. So switch frequency between 200 kHz to 600 kHz is highly recommended for most application. According to switch frequency, inductor value can be estimated as below:

$$L = \frac{\left(1 - \frac{V_{OUT}}{V_{IN}}\right) \times V_{OUT}}{0.3 \times I_{LED} \times f_{SW}}$$

For high efficiency, the inductor's DC resistance should be as small as possible.

For 1A application and 40°C temperature rising restriction, Figure 4 and 5 can provide a reference for selecting proper value of inductor.

PCB Size: double layer 5cm x 4.6cm

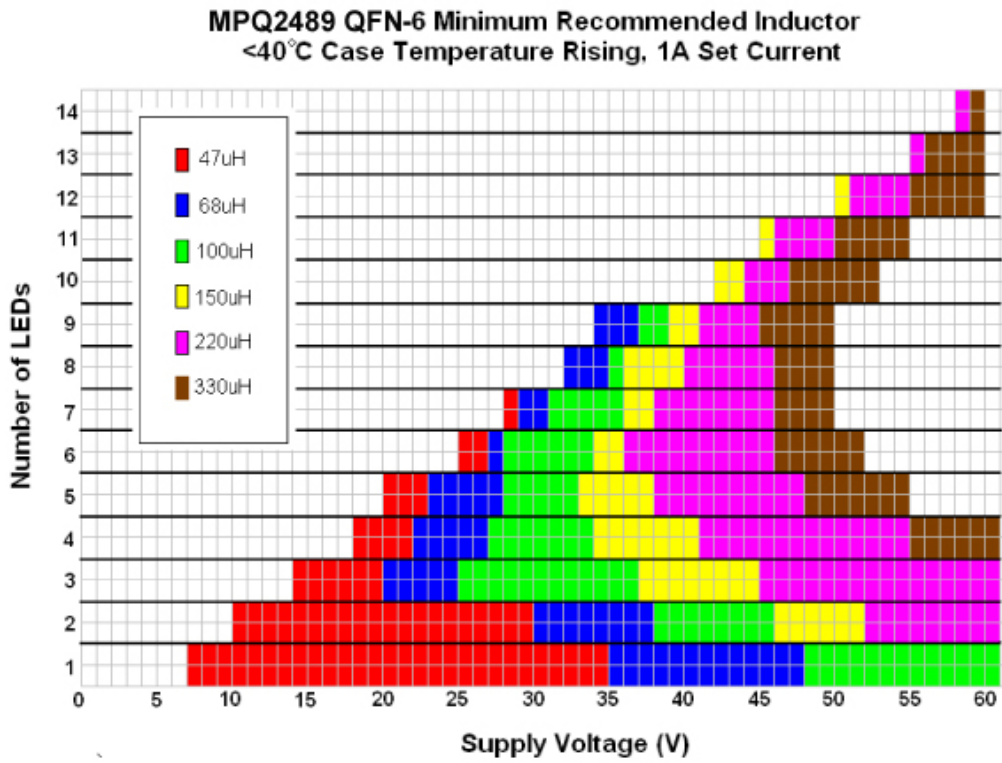

Figure 4—Inductor selection instruction for QFN-6

**Layout Consideration**

Careful attention must be paid to the PCB board layout and components placement.  $R_{SENSE}$  should be placed close to the IN pin and RS pin in order to minimize set current error. The input loop including input capacitor, schottky diode and internal MOSFET should be as short as possible.

**Radiation EMI Test Result**

Figure 5 and 6 represents EMI test results for EVQ2489.

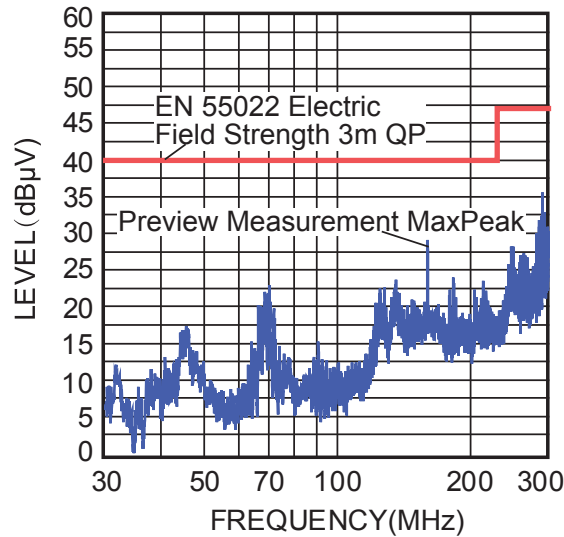

**Figure 5—EMI result, Vin=12VAC, Iout=0.24A, 3LEDs, OATS**

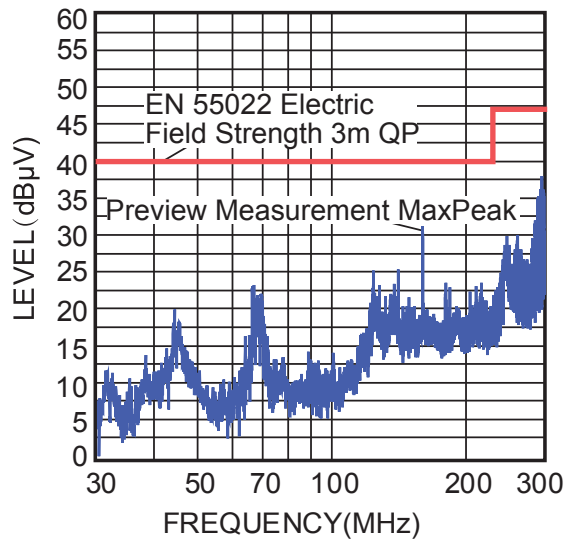

**Figure 6—EMI result, Vin=36VAC, Iout=0.35A, 3LEDs, OATS**

## PACKAGE INFORMATION

### QFN6 (3mm x 3mm)

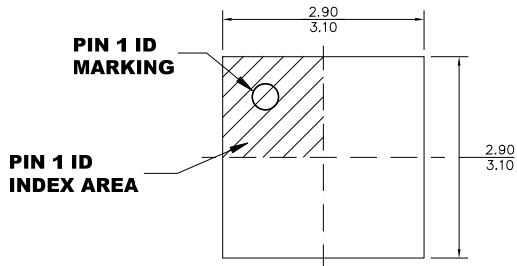

**TOP VIEW**

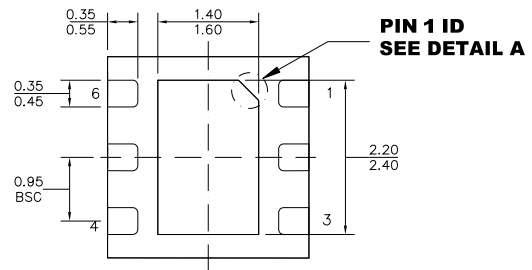

**BOTTOM VIEW**

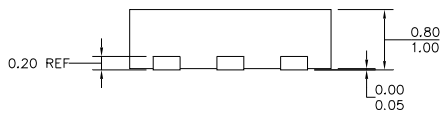

**SIDE VIEW**

**PIN 1 ID OPTION A**  
0.30x45° TYP.



**PIN 1 ID OPTION B**  
R0.25 TYP.



**DETAIL A**

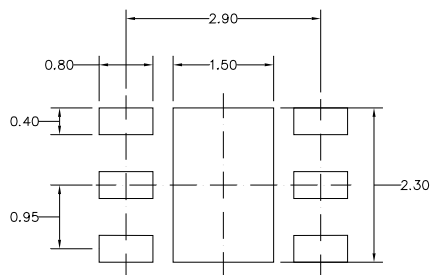

**RECOMMENDED LAND PATTERN**

**NOTE:**

- 1) ALL DIMENSIONS ARE IN MILLIMETERS.
- 2) EXPOSED PADDLE SIZE DOES NOT INCLUDE MOLD FLASH.
- 3) LEAD COPLANARITY SHALL BE 0.10 MILLIMETERS MAX.
- 4) JEDEC REFERENCE IS MO-229.
- 5) DRAWING IS NOT TO SCALE.

**NOTICE:** The information in this document is subject to change without notice. Users should warrant and guarantee that third party Intellectual Property rights are not infringed upon when integrating MPS products into any application. MPS will not assume any legal responsibility for any said applications.