



APPLICATIONS

- Battery-powered devices
- High-efficiency SMPS
- Embedded computing
- Input filters

FEATURES

- Size 4.9mmx4.9mmx4mm
- Semi-Shielded Construction
- Low DCR
- Low Stray Field
- Max Operating Temp +125°C
- RoHS/REACH-Compliant, Halogen Free

ELECTRICAL CHARACTERISTICS

Parameter			Value	Unit
Inductance ⁽¹⁾	L	±20%	1.5	μH
Resistance	R_{DC}	typ	14	mΩ
Resistance _{MAX}	$R_{DC\ MAX}$	max	17	mΩ
Rated Current ⁽²⁾	I_R	typ	6.2	A
Saturation Current _{25°C} ⁽³⁾	$I_{SAT\ 25°C}$	typ	9.3	A
Saturation Current _{100°C} ⁽⁴⁾	$I_{SAT\ 100°C}$	typ	8.4	A
Resonance Frequency	f_r	typ	70	MHz

GENERAL SPECIFICATIONS

(1) Inductance	Measured at 100kHz, 100mA
(2) Rated Current	Rated current will cause the coil temperature rise ΔT of 40K <i>I_R measured with the inductor soldered in a single-layer PCB. Copper layer thickness 35μm Cu / PCB size 30x50mm. Temperature behavior dependent on circuit design, PCB layout, proximity to other components, and trace dimensions and thickness.</i>
(3) Saturation Current _{25°C}	Saturation current will cause L to drop from 30% at 25°C ambient temperature
(4) Saturation Current _{100°C}	Saturation current will cause L to drop from 30% at 100°C ambient temperature
Temperature Test Condition	Electrical specifications measured at 25°C, 35% RH if not given differently
Operating Condition	Operating temperature: -40°C to +125°C (including temp rise) Should not exceed +125°C under worst-case operation conditions
Storage Condition	Tape and Reel packaging: -10°C to +40°C Humidity: <50% RH

All MPS parts are lead-free, halogen-free, and adhere to the RoHS directive. For MPS green status, please visit the MPS website under Quality Assurance. "MPS", the MPS logo, and "Simple, Easy Solutions" are registered trademarks of Monolithic Power Systems, Inc. or its subsidiaries.

TYPICAL PERFORMANCE CURVES

Temperature Rise vs. Current

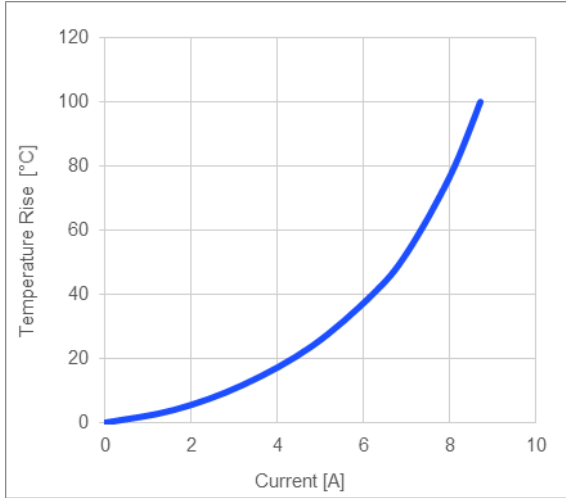

Inductance vs. Current

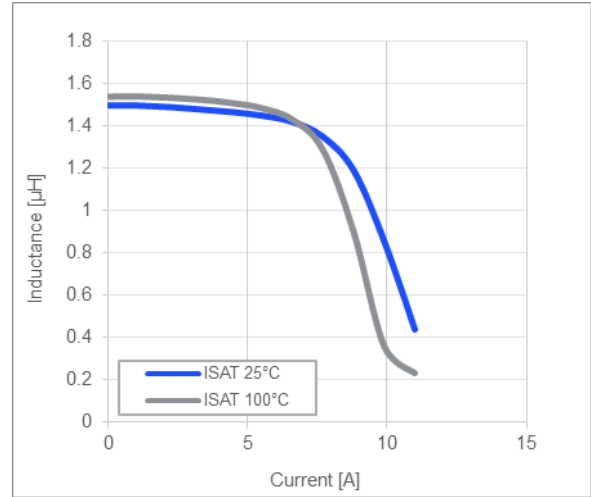

Impedance vs. Frequency

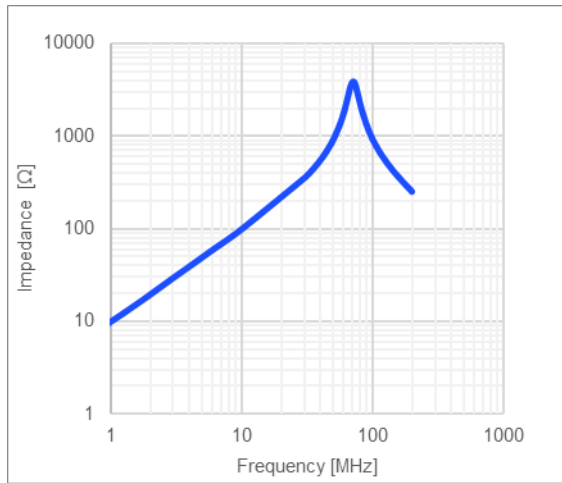

Inductance vs. Frequency

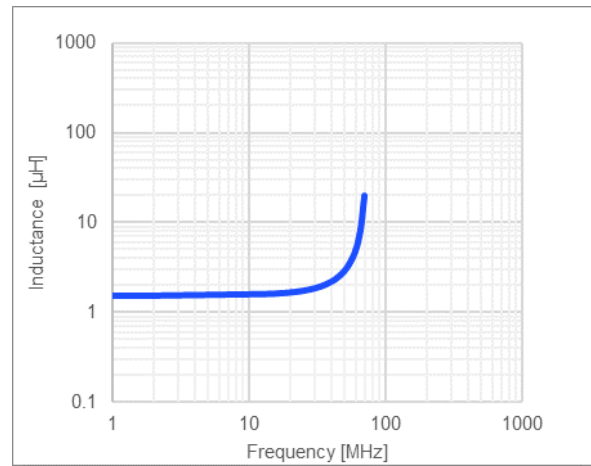

Quality Factor vs. Frequency

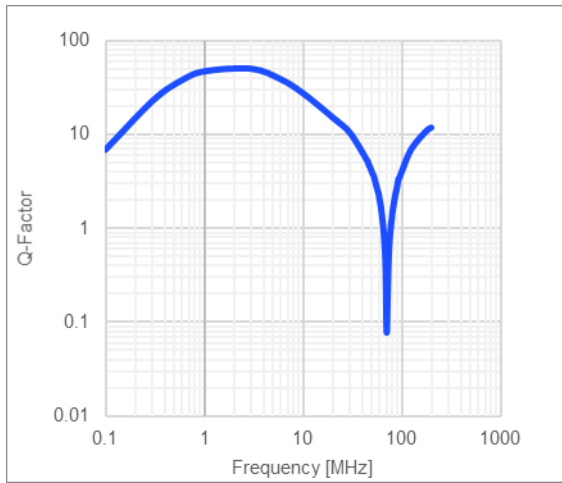

AC Resistance vs. Frequency

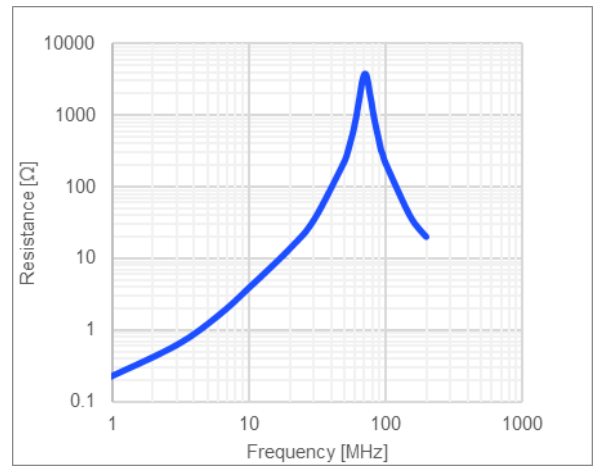

LAND PATTERN

Dimensions	
A	4.0 ref.
B	2.10 ref.
C	5.10 ref.

(unit in mm)



PRODUCT PACKAGE AND DIMENSIONS

Dimensions	
------------	--

(unit in mm)

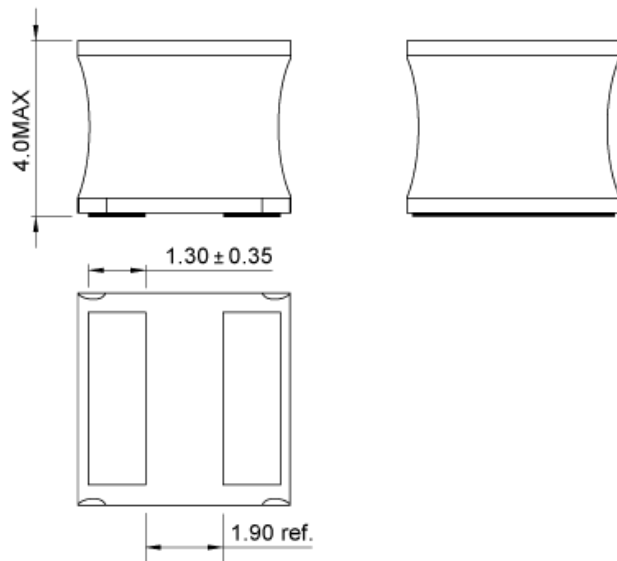
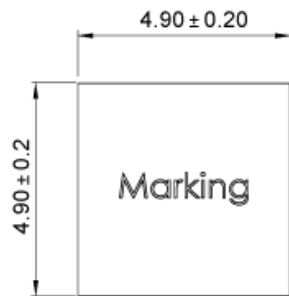

TOP MARKING

Marking	
Inductance Code	1R5

ORDERING INFORMATION

Part Number	$L^{(1)}$ typ (μH)	R_{DC} typ (mΩ)	$I_R^{(2)}$ typ (A)	$I_{SAT\ 25^{\circ}C}^{(3)}$ typ (A)	$I_{SAT\ 100^{\circ}C}^{(4)}$ typ (A)
MPL-SE5040-R47	0.47	7.3	8.0	16	13.5
MPL-SE5040-1R0	1.0	9.4	7.6	10.5	9
MPL-SE5040-1R5	1.5	14	6.2	9.3	8.4
MPL-SE5040-2R2	2.2	16	5.4	7.9	7.3
MPL-SE5040-3R3	3.3	22	5.2	6.4	5.2
MPL-SE5040-4R7	4.7	33	4.3	5	4.6
MPL-SE5040-6R8	6.8	45	3.5	4.6	4
MPL-SE5040-100	10	56	3.2	3.6	3
MPL-SE5040-150	15	83	2.5	2.9	2.6
MPL-SE5040-220	22	124	2.1	2.4	2.15

GENERAL SPECIFICATIONS
(1) Inductance

Measured at 100kHz, 100mA

(2) Rated Current

Rated current will cause the coil temperature rise ΔT of 40K
 I_R measured with the inductor soldered in a single-layer PCB. Copper layer thickness
 35μm Cu / PCB size 30x50mm. Temperature behavior dependent on circuit design,
 PCB layout, proximity to other components, and trace dimensions and thickness.

(3) Saturation Current $_{25^{\circ}C}$

Saturation current will cause L to drop from 30% at 25°C ambient temperature

(4) Saturation Current $_{100^{\circ}C}$

Saturation current will cause L to drop from 30% at 100°C ambient temperature

Temperature Test Condition

Electrical specifications measured at 25°C, 35% RH if not given differently

Operating Condition

Operating temperature: -40°C to +125°C (including temp rise)
 Should not exceed +125°C under worst-case operation conditions

Storage Condition

Tape and Reel packaging: -10°C to +40°C
 Humidity: <50% RH

NOTICE: The information in this document is subject to change without notice. Please contact MPS for current specifications. Users should warrant and guarantee that third-party Intellectual Property rights are not infringed upon when integrating MPS products into any application. MPS will not assume any legal responsibility for any said applications.