

DESCRIPTION

The MP6600 is a stepper motor driver with a built-in translator and current regulation. Current sensing is internal and requires no external sense resistors. High integration and a small package size make the MP6600 a space-saving and cost-effective solution for bipolar stepper motor drives.

The MP6600 operates from a supply voltage of up to 35V and can deliver motor currents up to 1.5A (depending on PCB design and thermal conditions). The MP6600 can operate a bipolar stepper motor in full-, half-, quarter-, or eighth-step modes. Internal safety features include over-current protection (OCP), input over-voltage protection (OVP), under-voltage lockout (UVLO), and thermal shutdown.

The MP6600 is available in a QFN-24 (4mmx4mm) package.

FEATURES

- Wide 4.5V to 35V Input Voltage Range
- Two Internal Full-Bridge Drivers
- Internal Current Sensing and Regulation
- Low On Resistance (HS: 195mΩ, LS: 170mΩ)
- No Control Power Supply Required
- Simple Logic Interface
- 3.3V and 5V Compatible Logic Supply
- Step Modes from Full-Step to Eighth-Step
- 1.5A Output Current
- Automatic Current Decay
- Over-Current Protection (OVP)
- Input Over-Voltage Protection (OVP)
- Thermal Shutdown and Under-Voltage Lockout (UVLO) Protection
- Fault Indication Output
- Available in a QFN-24 (4mmx4mm) Package

APPLICATIONS

- Bipolar Stepper Motors
- Printers

All MPS parts are lead-free, halogen-free, and adhere to the RoHS directive. For MPS green status, please visit the MPS website under Quality Assurance. "MPS" and "The Future of Analog IC Technology" are registered trademarks of Monolithic Power Systems, Inc.

TYPICAL APPLICATION

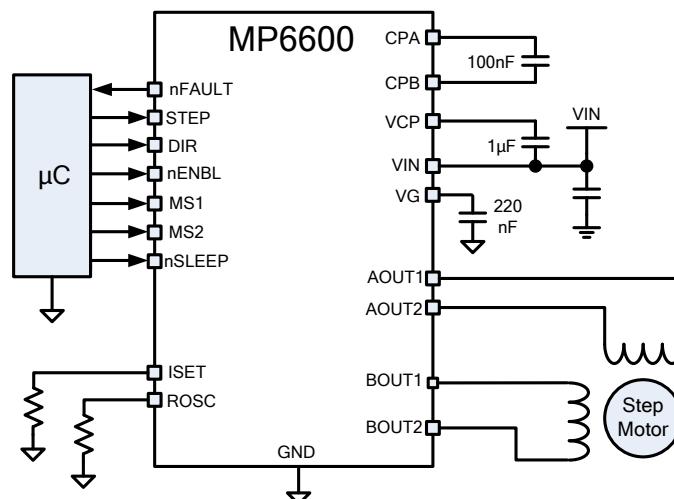

ORDERING INFORMATION

Part Number*	Package	Top Marking
MP6600GR*	QFN-24 (4mmx4mm)	See Below

* For Tape & Reel, add suffix -Z (e.g. MP6600GR-Z)

TOP MARKING

MPSYWW

MP6600

LLLLLL

MPS: MPS prefix
 Y: Year code
 WW: Week code
 MP6600: Part number
 LLLLLL: Lot number

PACKAGE REFERENCE

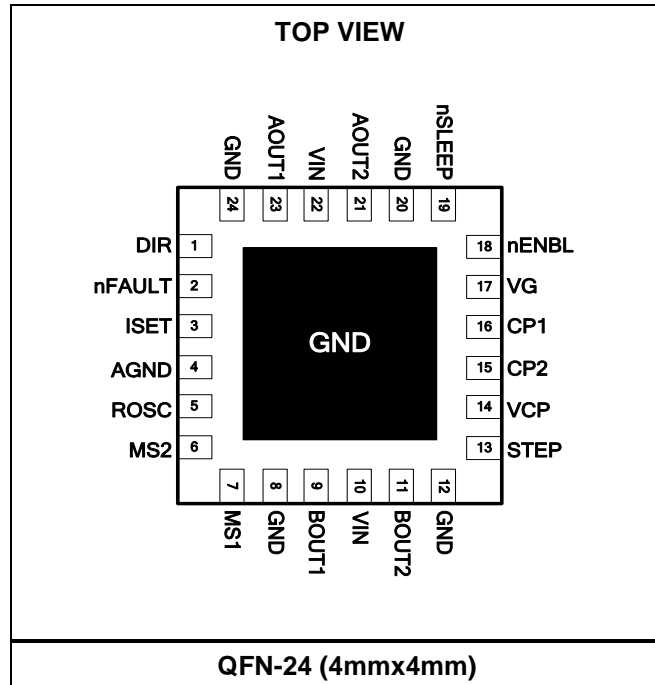

ABSOLUTE MAXIMUM RATINGS ⁽¹⁾

Supply voltage (VIN).....	-0.3V to 40V
xOUTx voltage (V _{A/BOU1/2}).....	-0.7V to 40V
VCP, CPB.....	VIN to VIN + 6.5V
All other pins to AGND.....	-0.3V to 6.5V
ESD rating (HBD)	2kV
Continuous power dissipation (T _A = +25°C) ⁽²⁾	2.9W
Storage temperature	-55°C to +150°C
Junction temperature	+150°C
Lead temperature (solder)	+260°C

Recommended Operating Conditions ⁽³⁾

Supply voltage (VIN).....	4.5V to 35V
Output current (I _{A,BOU})	±1.5A
Operating junction temp. (T _J)..	-40°C to +125°C

Thermal Resistance ⁽⁴⁾	θ_{JA}	θ_{JC}
QFN-24 (4mmx4mm)	42.....	9 °C/W

NOTES:

- 1) Exceeding these ratings may damage the device.
- 2) The maximum allowable power dissipation is a function of the maximum junction temperature T_J (MAX), the junction-to-ambient thermal resistance θ_{JA}, and the ambient temperature T_A. The maximum allowable continuous power dissipation at any ambient temperature is calculated by P_D (MAX) = (T_J (MAX)-T_A)/θ_{JA}. Exceeding the maximum allowable power dissipation produces an excessive die temperature, causing the regulator to go into thermal shutdown. Internal thermal shutdown circuitry protects the device from permanent damage.
- 3) The device is not guaranteed to function outside of its operating conditions.
- 4) Measured on JESD51-7, 4-layer PCB.

ELECTRICAL CHARACTERISTICS

V_{IN} = 24V, T_A = +25°C, unless otherwise noted.

Parameter	Symbol	Condition	Min	Typ	Max	Units
Power Supply						
Input supply voltage	V _{IN}		4.5	24	35	V
Quiescent current	I _Q	V _{IN} = 24V, nENBL = 0, nSLEEP = 1, with no load		1.5	5	mA
	I _{SLEEP}	V _{IN} = 24V, nSLEEP = 0			1	μA
Internal MOSFETs						
Output on resistance	R _{HS}	V _{IN} = 24V, I _{OUT} = 1A, T _J = 25°C		0.195	0.3	Ω
		V _{IN} = 24V, I _{OUT} = 1A, T _J = 85°C		0.25		Ω
	R _{LS}	V _{IN} = 24V, I _{OUT} = 1A, T _J = 25°C		0.17	0.3	Ω
		V _{IN} = 24V, I _{OUT} = 1A, T _J = 85°C		0.25		Ω
Body diode forward voltage	V _F	I _{OUT} = 1.5A			1.1	V
Control Logic						
Input logic low threshold	V _{IL}				0.8	V
Input logic high threshold	V _{IH}		2.1			V
Logic input current	I _{IN(H)}	V _{IH} = 5V			20	μA
	I _{IN(L)}	V _{IL} = 0.8V			5	μA
Internal pull-down resistance	R _{PD}			500		kΩ
Home nFAULT Outputs (Open-Drain Outputs)						
Output low voltage	V _{OL}	I _O = 5mA			0.5	V
Output high leakage current	I _{OH}	V _O = 3.3V			1	μA
Protection Circuit						
UVLO rising threshold	V _{IN_RISE}			3.4	4.5	V
Input OVP threshold	V _{OVP}		36	37.5	38.5	V
Input OVP hysteresis	ΔV _{OVP}			1900		mV
Over-current trip level	I _{OC1}	Sinking	3.5	6	8.5	A
	I _{OC2}	Sourcing	3.5	6	8.5	A
Over-current deglitch time	t _{OC}			1		μs
Thermal shutdown ⁽⁵⁾	T _{TSD}			165		°C
Thermal shutdown hysteresis ⁽⁵⁾	ΔT _{TSD}			15		°C
Current Regulation						
Constant off time	t _{OFF}	R _t = 200kΩ	20	23	26	μs
Peak current regulation level	I _{PEAK}	R _{ISET} = 71kΩ	0.95	1.0	1.05	A
ISET voltage	V _{ISET}		0.8	0.9	1	V
ISET current ratio	A _{ISET}	I _{ISET} /I _{OUT}	10	11.539	13	μA/A
Blanking time ⁽⁵⁾	t _{BLANK}			2		μs
Current trip accuracy	ΔI _{TRIP}	R _{ISET} = 71kΩ, 71% - 100%	-5		5	%
		R _{ISET} = 71kΩ, 38% - 67%	-9		9	%
		R _{ISET} = 71kΩ, <34%	-12		12	%

NOTE:

5) Guaranteed by design.

TIMING CHARACTERISTICS

VIN = 24V, TA = +25°C, unless otherwise noted.

Parameter	Symbol	Condition	Min	Typ	Max	Units
STEP high time	t1		1			μs
STEP low time	t2		1			μs
Setup time MSx, DIR to STEP rising	t3		200			ns
Hold time STEP rising to MSx, DIR change	t4		200			ns

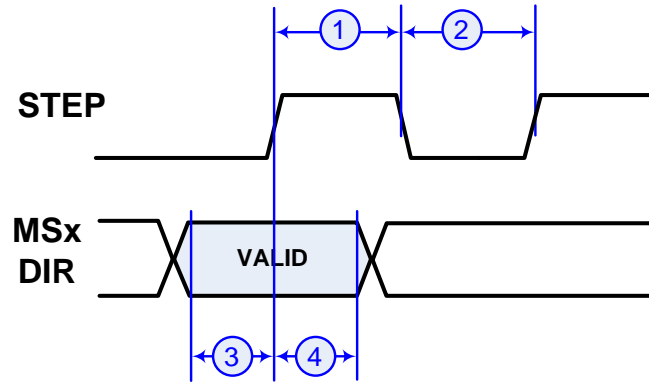

TYPICAL CHARACTERISTICS

ISET Voltage vs. Temperature

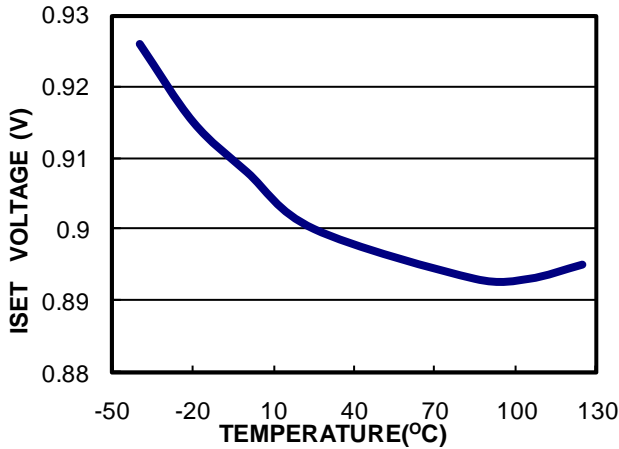

ISET Current Ratio vs. Temperature

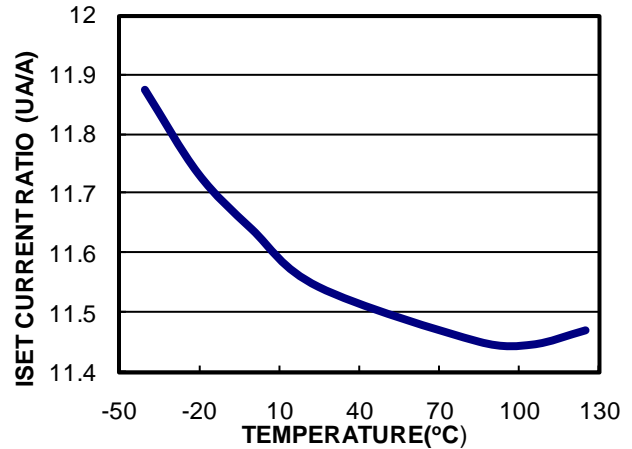

Bridge A HS On Resistance vs. Temperature

VIN = 24V, IOUT = 1A

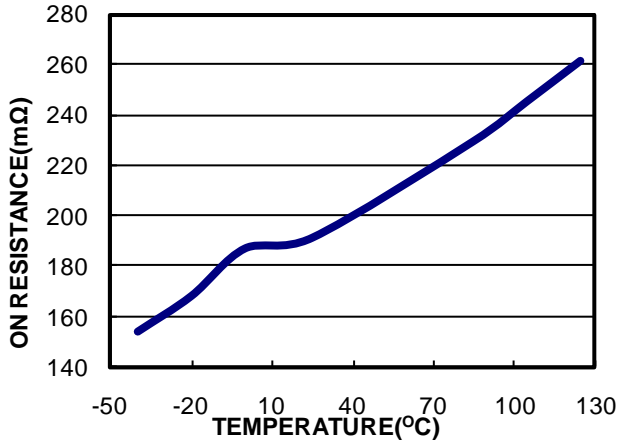

Bridge B HS On Resistance vs. Temperature

VIN = 24V, IOUT = 1A

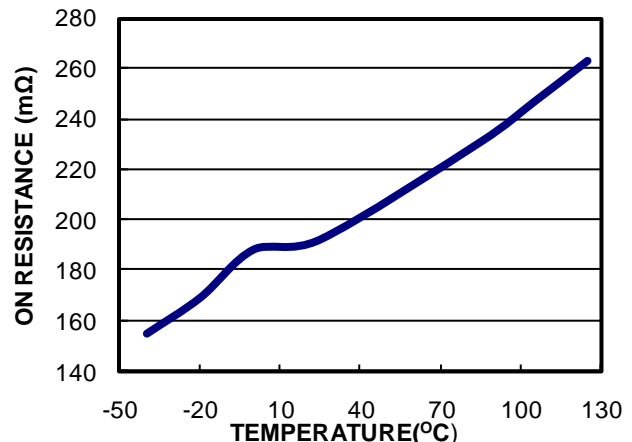

Bridge A LS On Resistance vs. Temperature

VIN = 24V, IOUT = 1A

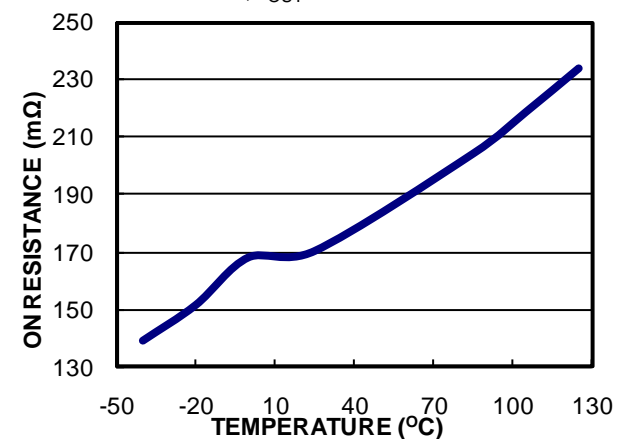

Bridge B LS On Resistance vs. Temperature

VIN = 24V, IOUT = 1A

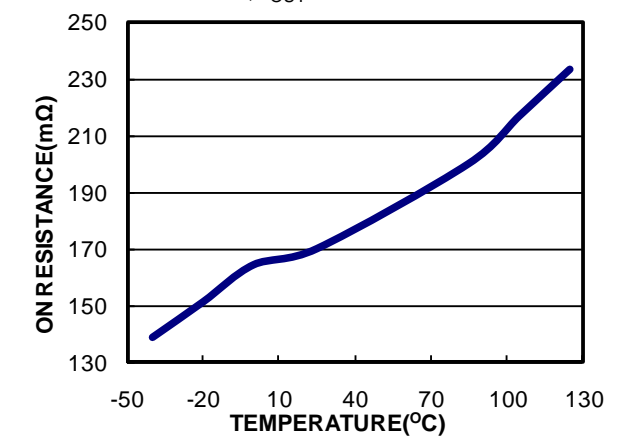

TYPICAL CHARACTERISTICS *(continued)*

Input OVP Threshold vs. Temperature

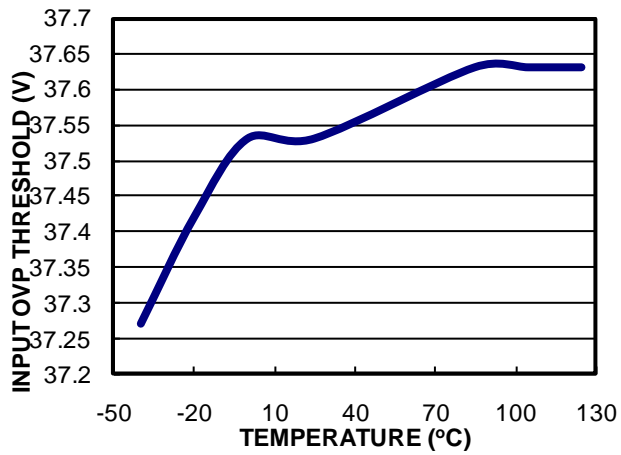

TYPICAL PERFORMANCE CHARACTERISTICS

$V_{IN} = 24V$, $I_{OUT} = 1.5A$, $F_{STEP} = 1kHz$, $T_A = 25^{\circ}C$, resistor + inductor load: $R = 3.3\Omega$, $L = 1.5mH/channel$, unless otherwise noted.

Steady State, Full Step

$I_{OUT} = 1A$

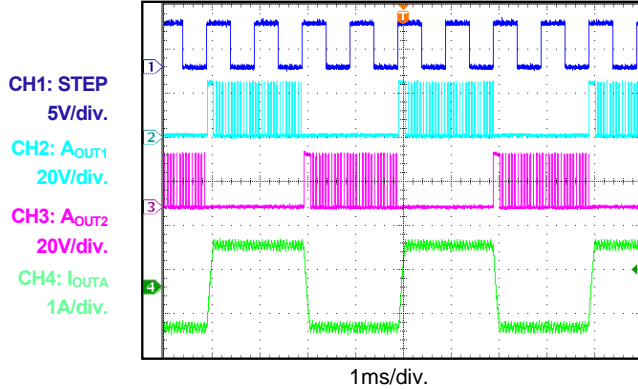

Steady State, Half Step

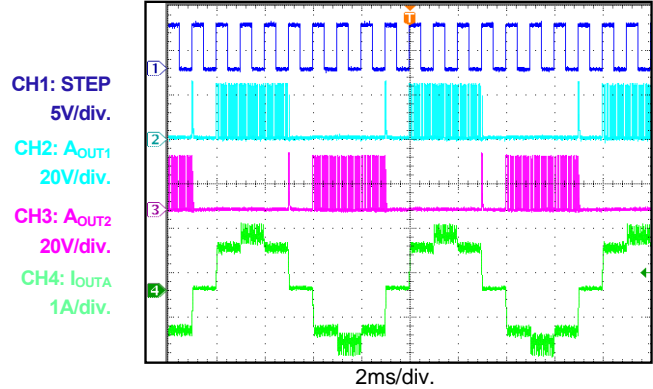

Steady State, Quarter Step

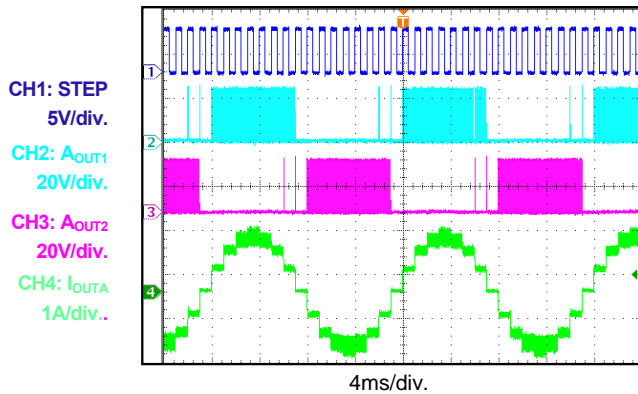

Steady State, Eighth Step

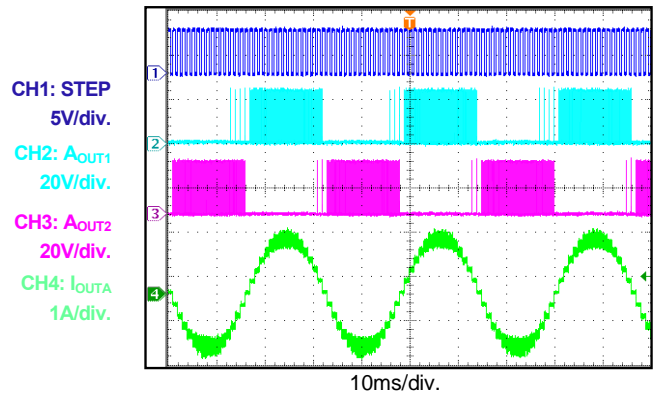

Power Ramp-Up, Full Step

$I_{OUT} = 1A$

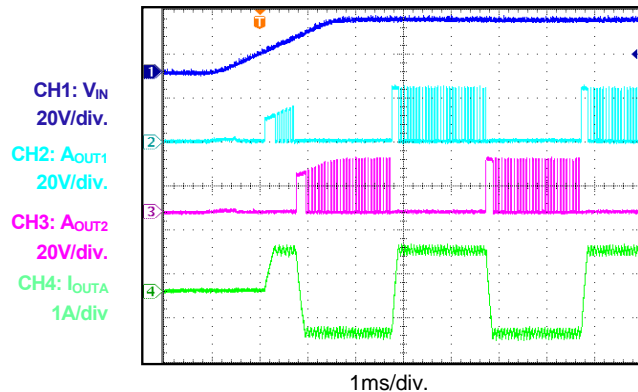

Power Ramp-Up, Half Step

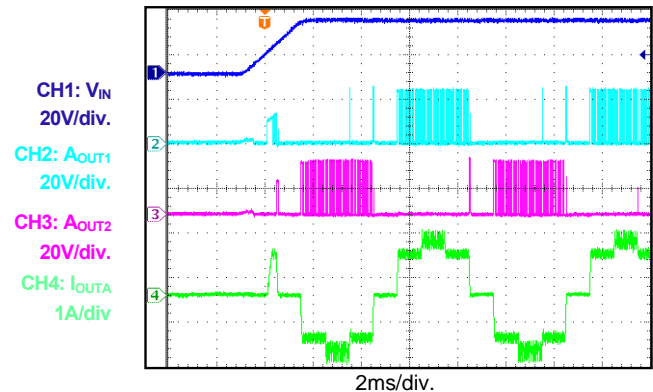

TYPICAL PERFORMANCE CHARACTERISTICS (continued)

$V_{IN} = 24V$, $I_{OUT} = 1.5A$, $F_{STEP} = 1kHz$, $T_A = 25^\circ C$, resistor + inductor load: $R = 3.3\Omega$, $L = 1.5mH/channel$, unless otherwise noted.

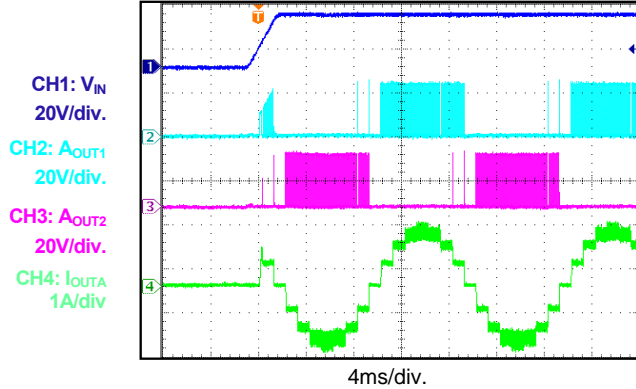
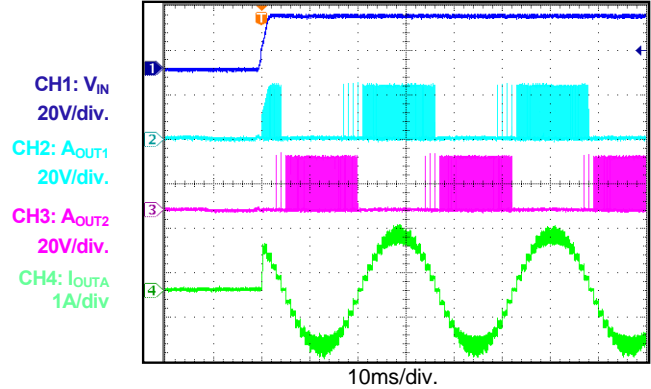
Power Ramp-Up, Quarter Step

Power Ramp-Up, Eighth Step

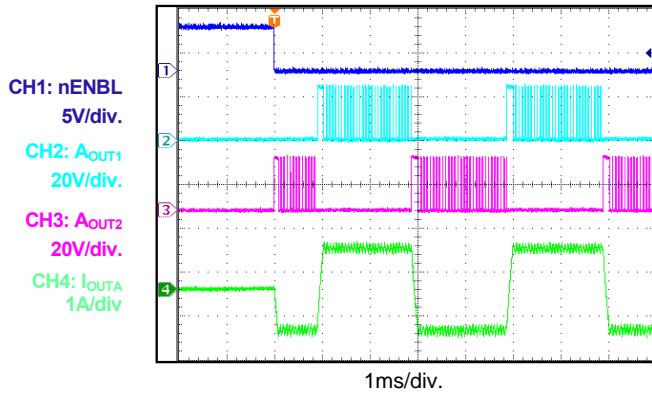
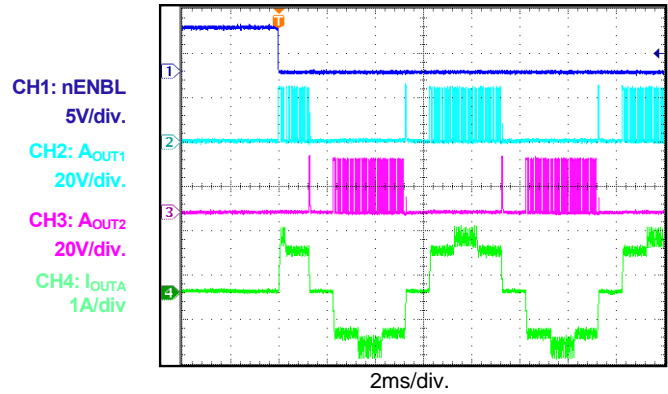
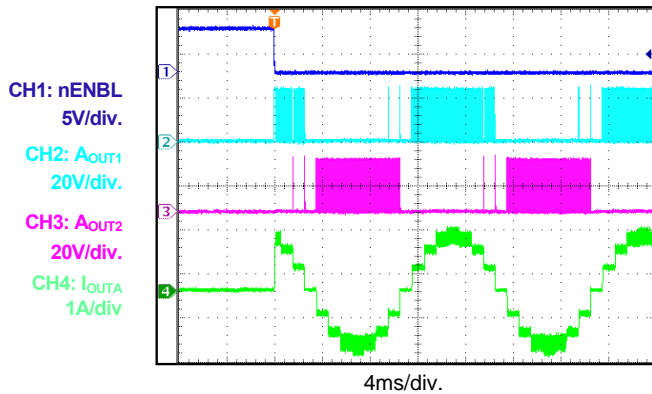
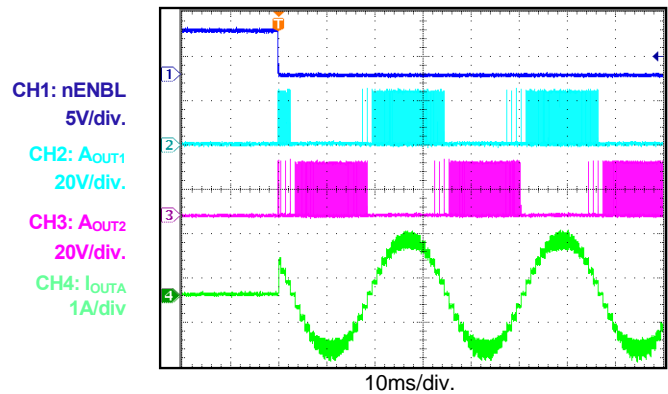
Enable, Full Step

$I_{OUT} = 2A$

Enable, Half Step

Enable, Quarter Step

Enable, Eighth Step

PIN FUNCTIONS

Pin # QFN	Name	Description
1	DIR	Direction input. DIR has an internal pull-down resistor.
2	nFAULT	Fault indication. nFAULT is an open-drain output. Drive nFAULT to logic low when in a fault condition (OCP, OTP, OVP).
3	ISET	Current set programming. A resistor from ISET to ground sets the current through the motor.
4	AGND	Analog ground.
5	ROSC	Constant off-time programming. A resistor from ROSC to ground sets the PWM off time.
6	MS2	Mode selection. MS1 and MS2 set the step mode (full, 1/2, 1/4, or 1/8 step). MS1 and MS2 have an internal pull-down resistor.
7	MS1	
8, 12, 20, 24, EP	GND	Power ground.
9	BOUT1	Bridge B output terminal 1.
10, 22	VIN	Input supply voltage. Both VIN pins must be connected to the same supply. Decouple VIN to ground with a minimum 100nF ceramic capacitor.
11	BOUT2	Bridge B output terminal 2.
13	STEP	Step input. The rising edge sequences the translator and advances the motor by one increment. STEP has an internal pull-down resistor.
14	VCP	Charge pump output. VCP requires a 1 μ F, 16V, ceramic capacitor to VIN.
15	CP2	Charge pump capacitor. Connect a 100nF ceramic capacitor rated for the VIN voltage between these terminals.
16	CP1	
17	VG	Low-side MOSFETs gate drive voltage. VG requires a 220nF, 16V, ceramic capacitor to ground.
18	nENBL	Enable input. Drive nENBL to logic high to disable the bridge outputs and translator operation. Drive nENBL to logic low to enable the bridge outputs and translator operation. nENBL has an internal pull-down resistor.
19	nSLEEP	Sleep mode input. Drive nSLEEP to logic high to enable normal operation. nSLEEP has an internal pull-down resistor.
21	AOUT2	Bridge A output terminal 2.
23	AOUT1	Bridge A output terminal 1.

BLOCK DIAGRAM

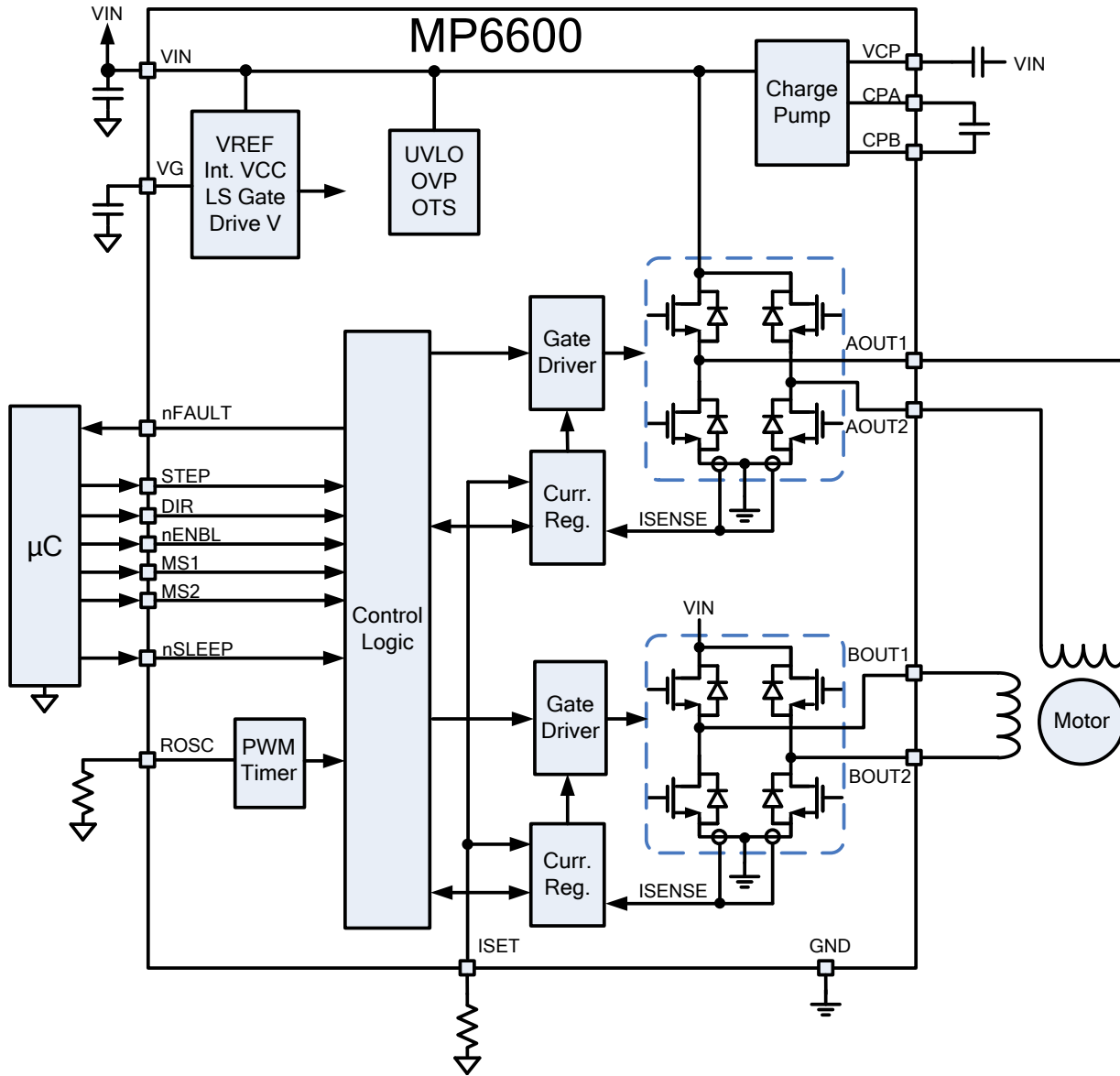

Figure 1: Functional Block Diagram

OPERATION

The MP6600 is a bipolar, stepper motor driver that integrates eight N-channel power MOSFETs arranged as two full-bridges with 1.5A of current capability each. The MP6600 operates over a wide 4.5V to 35V voltage supply range.

The MP6600 is designed to operate bipolar stepper motors in full-, half-, quarter-, and eighth-step modes. At each step, the current of each full-bridge is set by the output voltage of a DAC, which is controlled by the output of the translator.

The currents in each of the two outputs are regulated with programmable, constant off-time, pulse-width modulation (PWM) control circuitry. The MP6600 integrates internal current sensing with no external sense resistors required.

Stepping

The motor moves step-by-step by applying a series of pulses to STEP. A rising edge on the STEP input sequences the translator and advances the motor by one increment. The translator controls the input to the DACs and the direction of current flow in each winding. The amplitude of the increment (step size) is determined by the state of the inputs (MS1 and MS2) (see Table 1).

The state of DIR determines the direction of the rotation of the stepper motor.

The minimum STEP pulse width is 1µs. The logic control inputs MSx and DIR require at least 200ns of set-up time and hold time to the rising edge of the STEP input (see Figure 2).

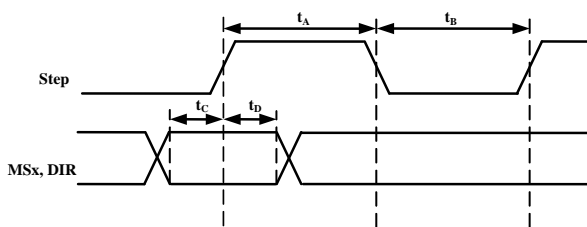

Figure 2: STEP Timing Diagram

Programmable Constant Off-Time Current Control

The motor current is regulated by a programmable constant off-time PWM current control circuit.

Initially, a diagonal pair of MOSFETs turns on and drives current through the motor winding. The current increases in the motor winding, which is sensed by an internal current sense circuit. During the initial blanking time (t_{BLANK}), the high-side MOSFET (HS-FET) always turns on in spite of current limit detection.

When the current reaches the current trip threshold, the internal current comparator either shuts off the HS-FET so the winding inductance current freewheels through the two low-side MOSFETs (LS-FET) (slow decay) or turns on another diagonal pair of MOSFETs so the current flows back to the input (fast decay). The current continues decreasing for the constant off-time duration unless a zero current level is detected. Afterward, the HS-FET is enabled to increase the winding current again. The cycle then repeats.

The constant off-time (t_{off}) is determined by the selection of an external resistor (R_{OSC}), which can be approximated with Equation (1):

$$t_{OFF} (ns) = 115 \times R_{OSC} (k\Omega) \quad (1)$$

The full-scale (100%) regulation current can be calculated with Equation (2):

$$I_{Max} = 71k\Omega / R_{ISET} \quad (2)$$

The DAC output reduces the trip current in precise steps. Calculate the trip current with Equation (3):

$$I_{Trip} = \%I_{Trip} \times I_{Max} \quad (3)$$

See Table 2 for $\%I_{Trip}$ at each step.

Blanking Time

There is usually a current spike during the switching transition due to the body diode's reverse-recovery current and the distributed winding capacitance of the motor. This current spike requires filtering to prevent it from erroneously shutting down the HS-FET.

After the PWM cycle begins, the output of the current sense comparator is ignored for the fixed blanking time. This blanking time results in a minimum on time for the PWM cycle.

Automatic Decay Mode

The MP6600 uses a fully automatic decay mode to provide accurate current regulation.

Initially, slow decay is used. At the end of the fixed off time, if the current is above the I_{TRIP} threshold, then fast decay mode is initiated by reversing the state of the H-bridge outputs.

Once the current level during this fast decay period drops below the I_{TRIP} threshold, slow decay is engaged again for another fixed off time. After the completion of this second fixed off time, a new PWM cycle begins.

Figure 3 below shows the automatic decay mode operation during a current reduction as a result of a step input.

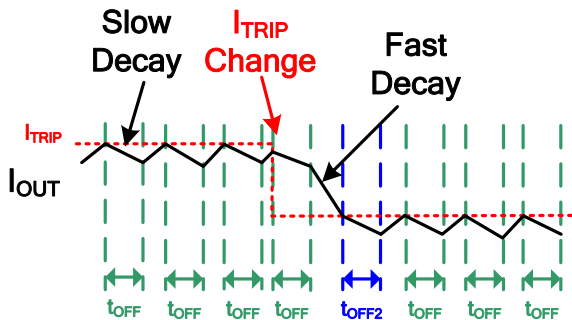

Figure 3: Slow Decay During t_{OFF} unless $I_{OUT} > I_{TRIP}$ at end of t_{OFF}

In some cases, specifically high voltage and low inductance or the regulation of very small currents, the minimum on time of the PWM cycle (set by the blanking time described above) can cause the current to rise very quickly. In this case, both slow and fast decay are used (see Figure 4).

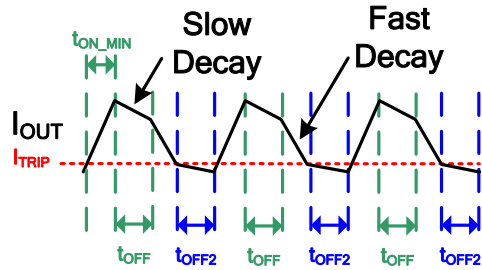

Figure 4: Current Regulation of Low Current/Low Inductance

Microstep Selection (MS1, MS2)

The step mode is selected by applying logic high and low voltages to MS1 and MS2 (see Table 1). The MP6600 supports full-, half-, quarter-, and eighth-step modes for progressively finer step resolution and control.

Table 1: Stepping Format

MS2	MS1	STEP Mode
L	L	Full step
L	H	Half step
H	L	Quarter step
H	H	Eighth step

Full-step mode has four states with each motor winding driven with either 70.7% of the maximum positive current or 70.7% of the maximum negative current. This provides four steps per electrical rotation. Half-step mode creates eight steps per electrical rotation. Quarter- and eighth-step modes provide 16 and 32 steps per rotation respectively.

MICROSTEPPING

Table and Figure 5 show the relative current level sequence for different settings of MSx.

The MSx pins have internal pull-down resistors.

nSLEEP, nENBL Operation

Driving nSLEEP low puts the device into a low-power sleep state. In this state, the gate drive charge pump is stopped, and all the internal circuits and H-bridge outputs are disabled. All inputs are ignored when nSLEEP is active low.

When waking up from sleep mode, approximately 1ms of time must pass before a STEP command can be issued to allow the internal circuitry to stabilize. nSLEEP has an internal pull-down resistor.

The nENBL pin is used to control the output drivers. When nENBL is low, the output H-bridge outputs are enabled, and the rising edges on STEP are recognized. When nENBL is high, the H-bridge outputs are disabled, and the STEP input is ignored. nENBL has an internal pull-down resistor.

Fault Reporting

The MP6600 provides an nFAULT pin, which reports if a fault condition (such as OCP, OTP, or OVP) occurs. nFAULT is an open-drain output and is driven low when a fault condition occurs. If the fault condition is removed, nFAULT is pulled high by an external pull-up resistor.

Over-Current Protection (OCP)

Over-current protection (OCP) circuitry limits the current through the MOSFETs by disabling the gate driver. If the over-current limit threshold is exceeded for longer than the over-current deglitch time, all MOSFETs in the H-bridge are disabled, and nFAULT is driven low. The driver remains disabled for 2.4ms typically, at which time it is re-enabled automatically.

Over-current conditions on both high- and low-side devices (i.e.: a short to ground, supply, or across the motor winding) result in an over-current shutdown. Note that OCP does not use the current sense circuitry used for PWM current control.

Over-Voltage Protection (OVP)

If the input voltage on VIN is higher than the over-voltage protection (OVP) threshold, the H-bridge output is disabled, and nFAULT is driven low. This protection is released when VIN drops below 36V.

Input Under-Voltage Lockout (UVLO) Protection

If at any time the voltage on VIN falls below the under-voltage lockout (UVLO) threshold voltage, all circuitry in the device is disabled, and the internal logic is reset. Operation resumes when VIN rises above the UVLO threshold.

Thermal Shutdown

If the die temperature exceeds safe limits, all MOSFETs in the H-bridge are disabled, and nFAULT is driven low. Once the die temperature has fallen to a safe level, operation resumes automatically.

MICROSTEPPING

Table 2: Relative Current Level Sequence

Eighth Step #	Quarter Step #	Half Step #	Full Step #	Phase A Current % I_{TRIP} -LIMIT (%)	Phase B Current % I_{TRIP} -LIMIT (%)	Step Angle (°)
1	1	1		100.00	0.00	0.0
2				98.08	19.51	11.3
3	2			92.39	38.27	22.5
4				83.15	55.56	33.8
5	3	2	1	70.71	70.71	45.0
6				55.56	83.15	56.3
7	4			38.27	92.39	67.5
8				19.51	98.08	78.8
9	5	3		0.00	100.00	90.0
10				-19.51	98.08	101.3
11	6			-38.27	92.39	112.5
12				-55.56	83.15	123.8
13	7	4	2	-70.71	70.71	135.0
14				-83.15	55.56	146.3
15	8			-92.39	38.27	157.5
16				-98.08	19.51	168.8
17	9	5		-100.00	0.00	180.0
18				-98.08	-19.51	191.3
19	10			-92.39	-38.27	202.5
20				-83.15	-55.56	213.8
21	11	6	3	-70.71	-70.71	225.0
22				-55.56	-83.15	236.3
23	12			-38.27	-92.39	247.5
24				-19.51	-98.08	258.8
25	13	7		0.00	-100.00	270.0
26				19.51	-98.08	281.3
27	14			38.27	-92.39	292.5
28				55.56	-83.15	303.8
29	15	8	4	70.71	-70.71	315.0
30				83.15	-55.56	326.3
31	16			92.39	-38.27	337.5
32				98.08	-19.51	348.8

MICROSTEPPING *(continued)*

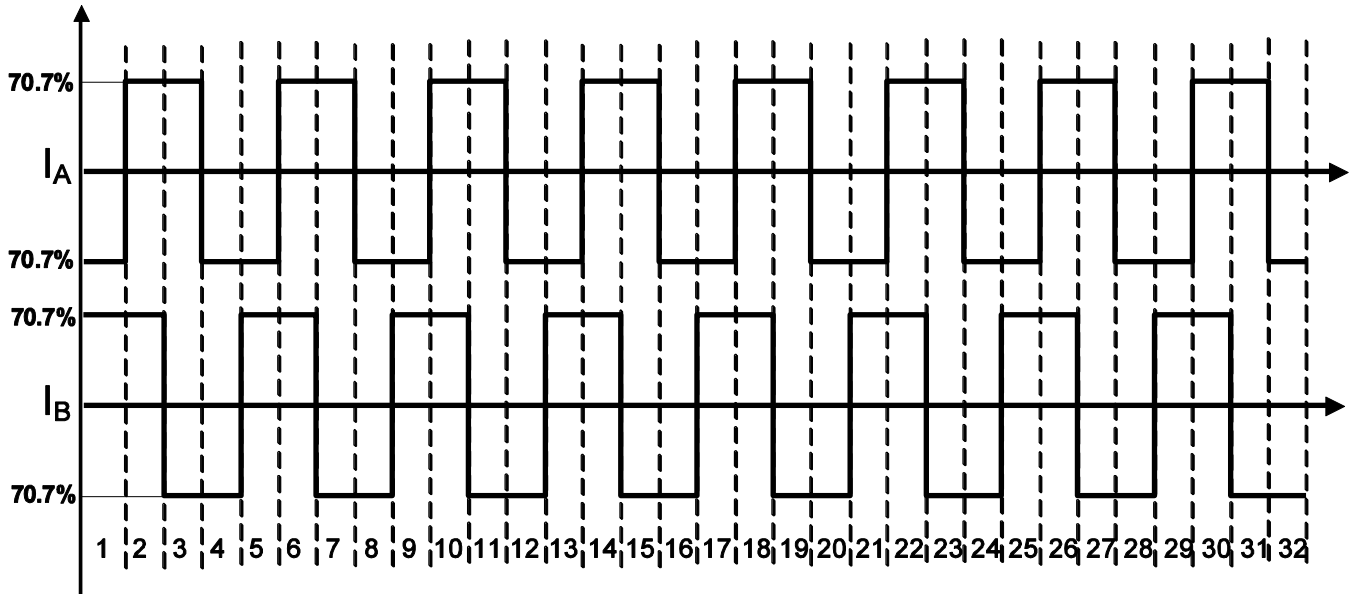

Figure 5a: Full Step (4 Step Sequences)

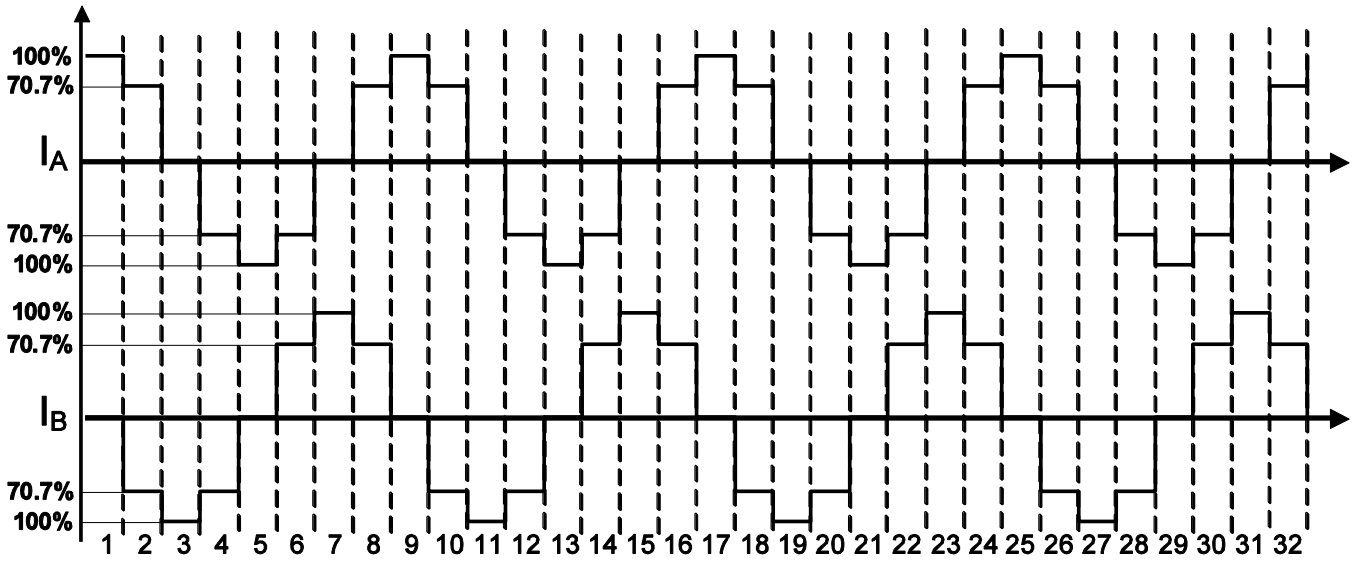

Figure 5b: Half Step (8 Step Sequences)

MICROSTEPPING (continued)

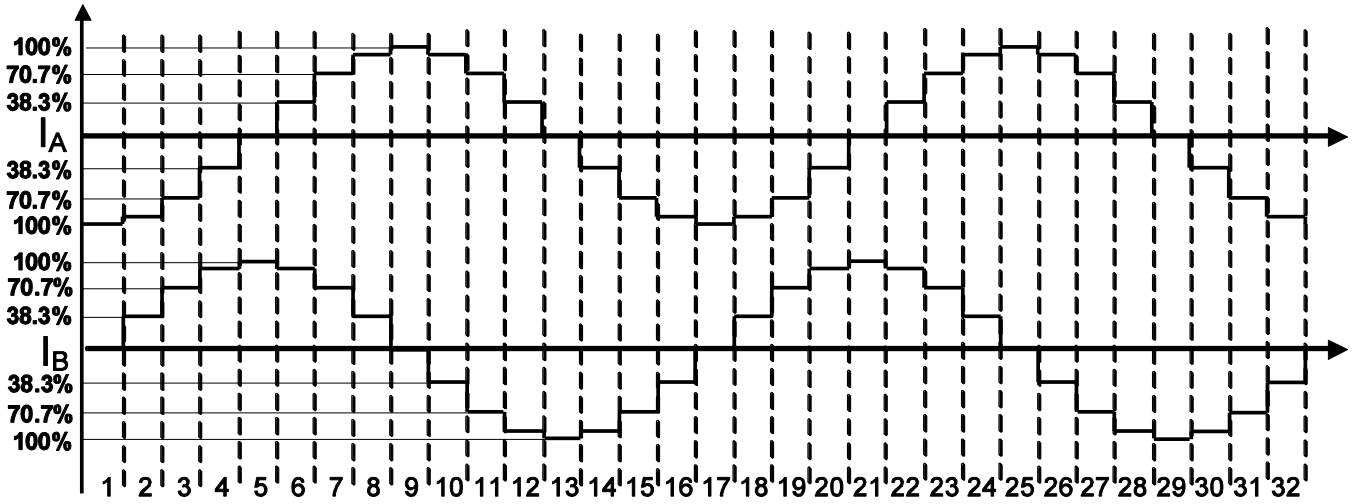

Figure 5c: Quarter Step (16 Step)

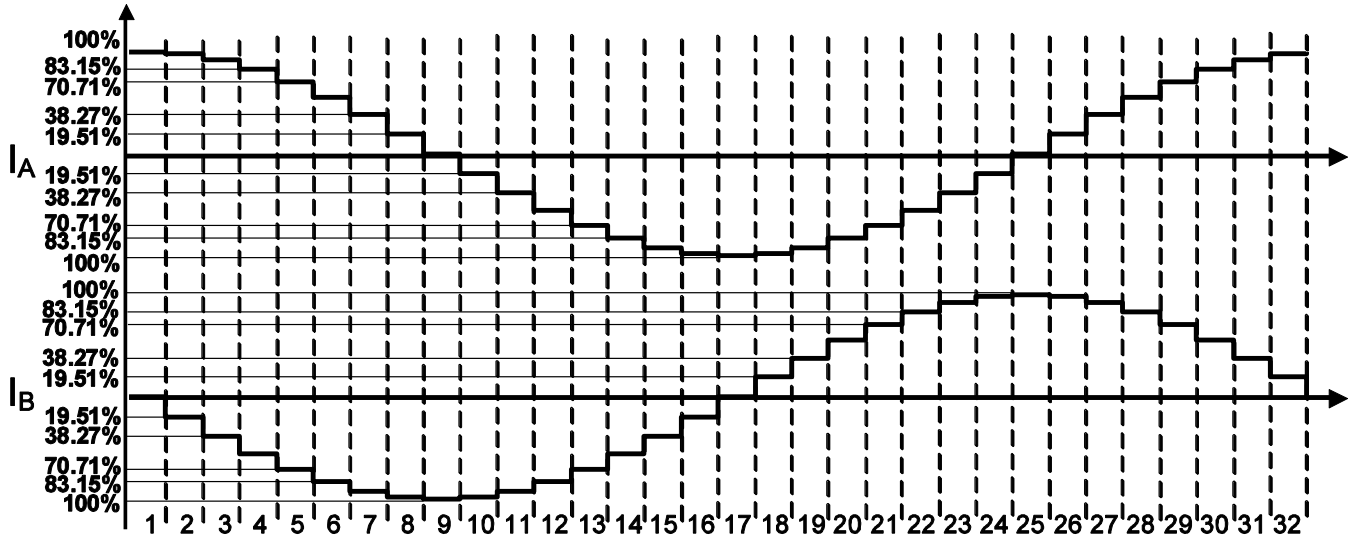
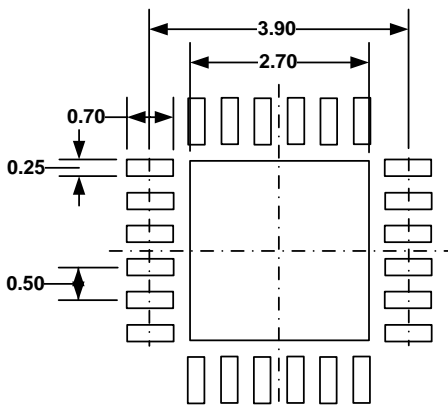
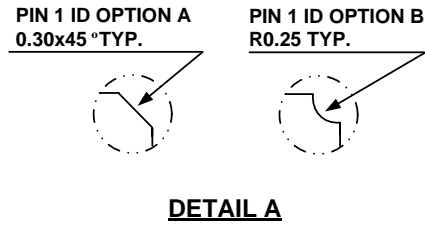
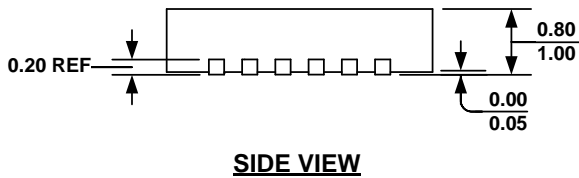
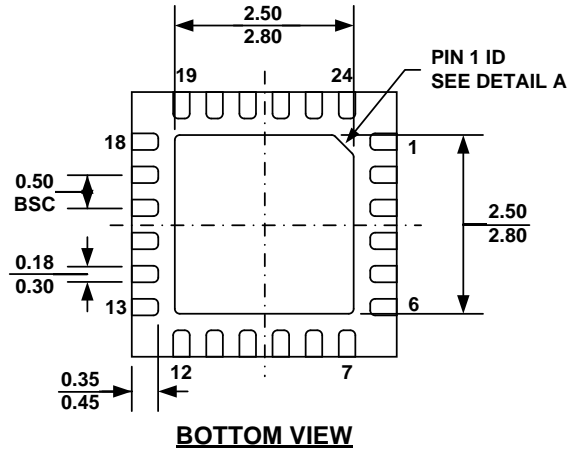
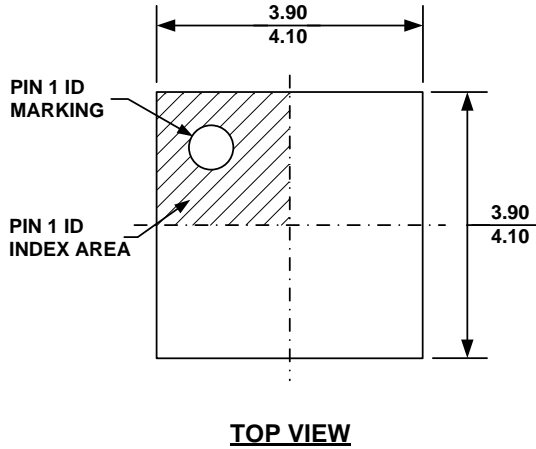

Figure 5d: Eighth Step (32 Step)

PACKAGE INFORMATION

QFN-24 (4mmx4mm)



NOTE:

- 1) ALL DIMENSIONS ARE IN MILLIMETERS.
- 2) EXPOSED PADDLE SIZE DOES NOT INCLUDE MOLD FLASH.
- 3) LEAD COPLANARITY SHALL BE 0.10 MILLIMETER MAX.
- 4) DRAWING CONFIRMS TO JEDEC MO-220, VARIATION VGGD.
- 5) DRAWING IS NOT TO SCALE.

NOTICE: The information in this document is subject to change without notice. Please contact MPS for current specifications. Users should warrant and guarantee that third party Intellectual Property rights are not infringed upon when integrating MPS products into any application. MPS will not assume any legal responsibility for any said applications.