



The Future of Analog IC Technology®

MP6522

35V, 3.2A, H-Bridge Motor Driver

DESCRIPTION

The MP6522 is an H-bridge motor driver that operates from a supply voltage of up to 35V and delivers a peak motor current of up to 3.2A. The MP6522 is typically used to drive DC brush motors.

An internal current-sensing circuit provides an output with a voltage proportional to the load current. Additionally, cycle-by-cycle current regulation and limiting is provided. These features do not require the use of a low-ohm shunt resistor.

Full protection features include over-current protection (OCP), input over-voltage protection (OVP), under-voltage lockout (UVLO), and thermal shutdown.

The MP6522 is available in a 24-pin QFN (5mmx5mm) package with an exposed thermal pad.

FEATURES

- Wide 5.4V to 35V Input Voltage Range
- 3.2A Maximum Output Current
- Internal, Full, H-Bridge Driver
- Cycle-by-Cycle Current Regulation and Limiting
- Low On Resistance (HS: 300mΩ; LS: 300mΩ)
- Simple, Versatile Logic Interfaces
- 3.3V and 5V Compatible Logic Inputs
- Over-Current Protection (OCP)
- Over-Voltage Protection (OVP)
- Thermal Shutdown
- Under-Voltage Lockout (UVLO)
- Fault Indication Output
- Thermally Enhanced Surface-Mount Package
- Available in a QFN-24 (5mmx5mm) Package

APPLICATIONS

- Solenoid Drivers
- DC Brush Motor Drives

All MPS parts are lead-free, halogen-free, and adhere to the RoHS directive. For MPS green status, please visit the MPS website under Quality Assurance. "MPS" and "The Future of Analog IC Technology" are registered trademarks of Monolithic Power Systems, Inc.

TYPICAL APPLICATION

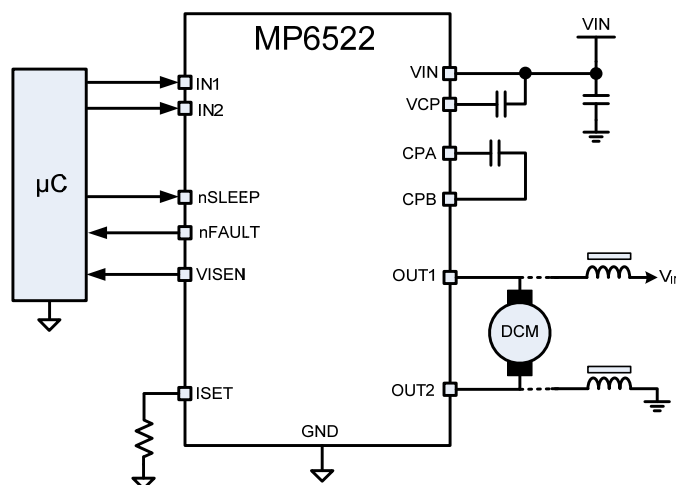

ORDERING INFORMATION

Part Number*	Package	Top Marking
MP6522GU*	QFN-24 (5mmx5mm)	See Below

* For Tape & Reel, add suffix -Z (e.g. MP6522GU-Z)

TOP MARKING

MPSYYWW

MP6522

LLLLLLL

MPS: MPS prefix
 YY: Year code
 WW: Week code
 MP6522: Part number
 LLLLLLL: Lot number

PACKAGE REFERENCE

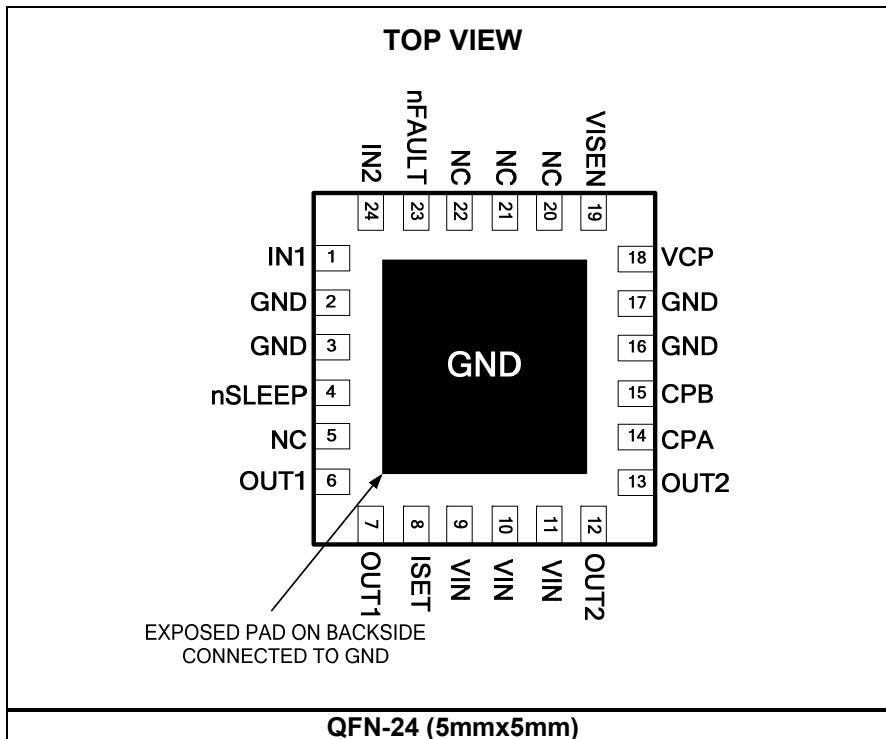

ABSOLUTE MAXIMUM RATINGS ⁽¹⁾

Supply voltage (VIN).....	-0.3V to 40V
OUTx voltage (V _{OUT1/2}).....	-0.7V to 40V
VCP, CPB	VIN to VIN + 6.5V
ISET	-0.3V to 4.5V
All other pins to GND	-0.3V to 6.5V
ESD rating (HBD).....	2kV
Continuous power dissipation (T _A = +25°C) ⁽²⁾	3.5W
Storage temperature	-55°C to +150°C
Junction temperature	+150°C
Lead temperature (solder)	+260°C

Recommended Operating Conditions ⁽³⁾

Supply voltage (VIN).....	5.4V to 35V
Peak output current (I _{OUT})	±3.2A
Load current (I _{ISEN})	±2mA
Operating junction temp. (T _J).....	-40°C to +125°C

Thermal Resistance ⁽⁴⁾	θ_{JA}	θ_{JC}
QFN-24 (5mmx5mm).....	36	8
	°C/W	

NOTES:

- 1) Exceeding these ratings may damage the device.
- 2) The maximum allowable power dissipation is a function of the maximum junction temperature T_J (MAX), the junction-to-ambient thermal resistance θ_{JA}, and the ambient temperature T_A. The maximum allowable continuous power dissipation at any ambient temperature is calculated by P_D (MAX) = (T_J (MAX)-T_A)/θ_{JA}. Exceeding the maximum allowable power dissipation produces an excessive die temperature, causing the regulator to go into thermal shutdown. Internal thermal shutdown circuitry protects the device from permanent damage.
- 3) The device is not guaranteed to function outside of its operating conditions.
- 4) Measured on JESD51-7, 4-layer PCB.

ELECTRICAL CHARACTERISTICS
V_{IN} = 24V, T_A = +25°C, unless otherwise noted.

Parameter	Symbol	Condition	Min	Typ	Max	Units
Power Supply						
Input supply voltage	V _{IN}		5.4	24	35	V
Quiescent current	I _Q	V _{IN} = 24V, nSLEEP = 1, no load current		1.5	2	mA
	I _{SLEEP}	V _{IN} = 24V, nSLEEP = 0			1	μA
Charge pump frequency	f _{CP}			660		kHz
Internal MOSFETs						
Output on resistance	R _{HS}	V _{IN} = 24V, I _{OUT} = 1A, T _J = 25°C		0.3	0.45	Ω
		V _{IN} = 24V, I _{OUT} = 1A, T _J = 85°C		0.35		Ω
	R _{LS}	V _{IN} = 24V, I _{OUT} = 1A, T _J = 25°C		0.3	0.45	Ω
		V _{IN} = 24V, I _{OUT} = 1A, T _J = 85°C		0.35		Ω
Body diode forward voltage	V _F	I _{OUT} = 1.5A			1.1	V
Control Logic						
Input logic low threshold	V _{IL}				0.8	V
Input logic high threshold	V _{IH}		2			V
Logic input current	I _{IN(H)}	V _{IH} = 5V	-12		12	μA
	I _{IN(L)}	V _{IL} = 0.8V	-2		2	μA
Internal pull-down resistance	R _{PD}			530		kΩ
nFault Output (Open-Drain Output)						
Output low voltage	V _{OL}	I _O = 5mA			0.5	V
Output high leakage current	I _{OH}	V _O = 3.3V			1	μA
Protection Circuits						
UVLO rising threshold	V _{IN_RISE}			5.1	5.3	V
UVLO hysteresis	V _{HYS}			310		mV
Input OVP threshold	V _{OVP}		36	38	40	V
Input OVP hysteresis	ΔV _{OVP}			2000		mV
Over-current trip level	I _{OCP1}	Sinking	3.2	4	5.2	A
	I _{OCP2}	Sourcing	3.2	4	5.2	A
Over-current deglitch time	t _{OCPD}			500		ns
Over-current retry time	t _{OCP}			0.9		ms
Thermal shutdown	T _{TSD}			165		°C
Thermal shutdown hysteresis	ΔT _{TSD}			30		°C
Current Control						
Off time	t _{ITRIP}	After ITRIP		17		μs
ISET current	I _{SET}		90	100	110	μA/A
Current trip voltage (rising)	V _{ITRIP-R}	At VISEN	1.44	1.5	1.56	V
Current trip voltage (falling)	V _{ITRIP-F}	At VISEN	1.15	1.2	1.25	V
VISEN Output						
Output voltage accuracy	ΔV _{VISEN}	V _{ISET} > 0.5V	-5		5	%

TYPICAL CHARACTERISTICS

Current Sense

I_{SET} Resistor = 1k Ω

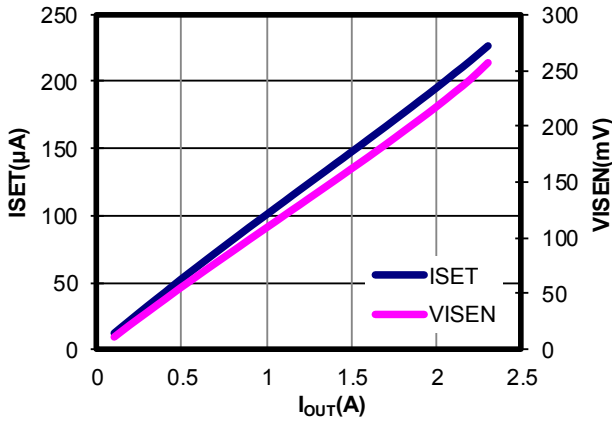

ISET vs. Temperature

I_{OUT} = 1A

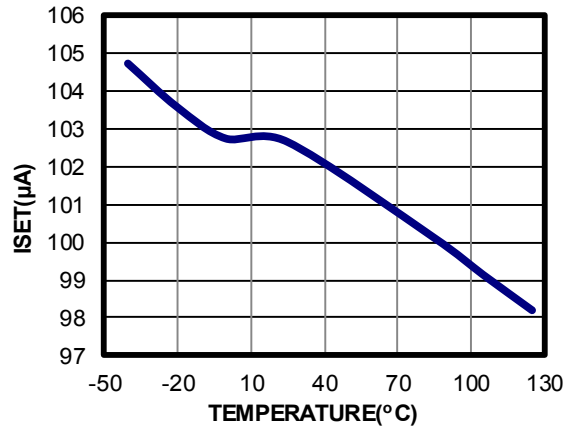

Current Trip Voltage (Rising) vs. Temperature

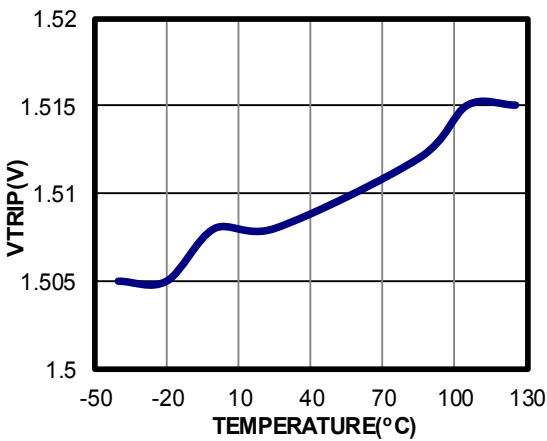

Current Trip Voltage (Falling) vs. Temperature

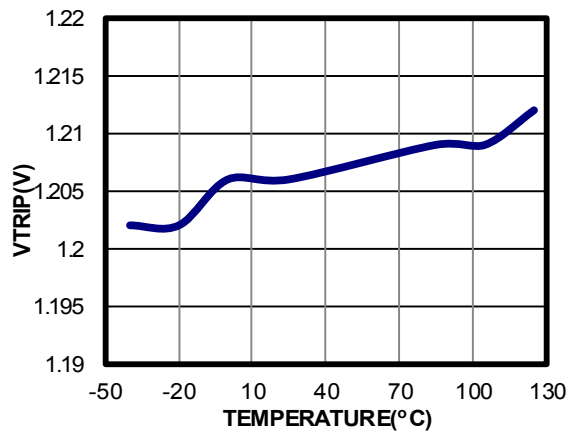

HS R_{ON} vs. Temperature

I_{OUT} = 1A

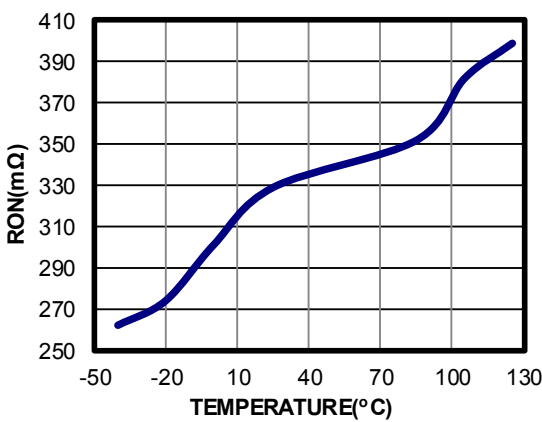

LS R_{ON} vs. Temperature

I_{OUT} = 1A

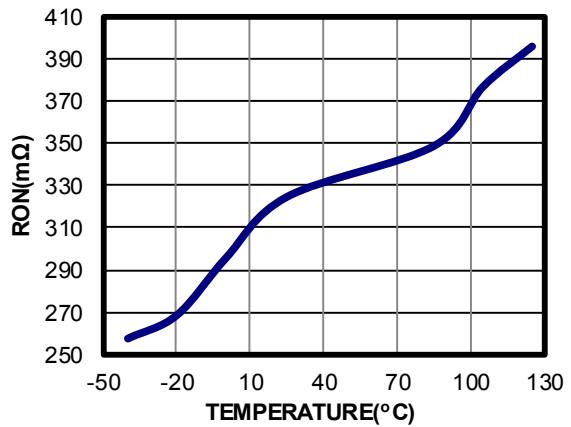

TYPICAL PERFORMANCE CHARACTERISTICS

V_{IN} = 24V, I_{OUT} = 1A, T_A = 25°C, unless otherwise noted.

Steady State

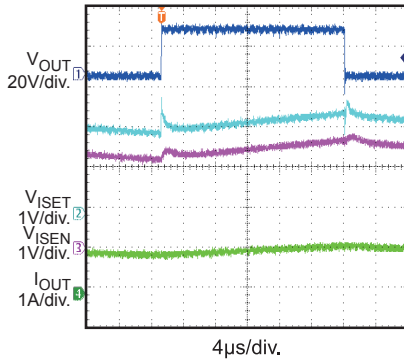

Input Power Start-Up

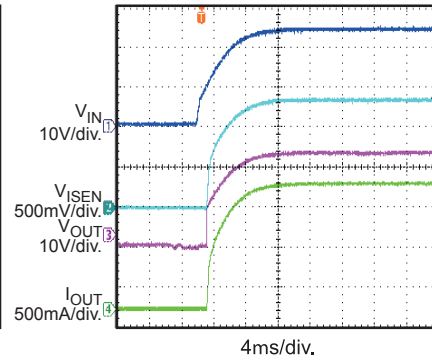

Input Power Shutdown

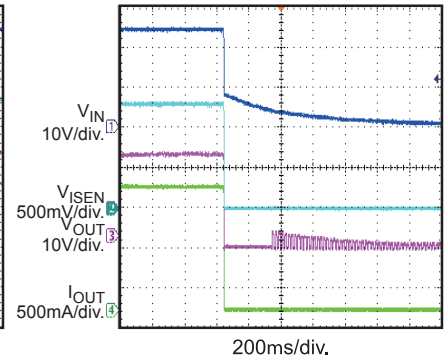

Sleep Shutdown

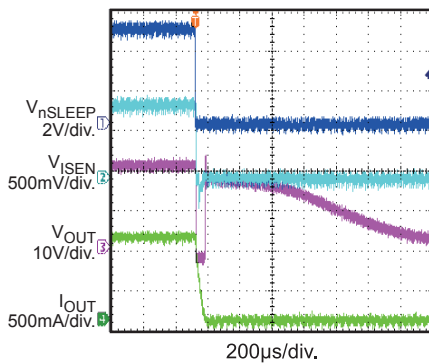

Sleep Start-Up

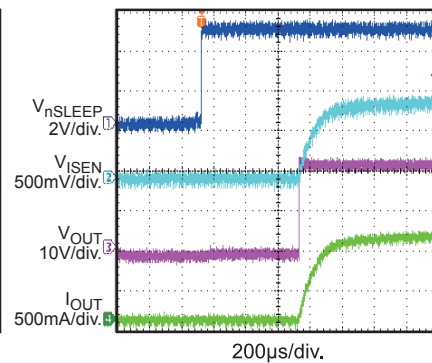

SCP

V_{IN} = 35V, OUT1 Short to OUT2

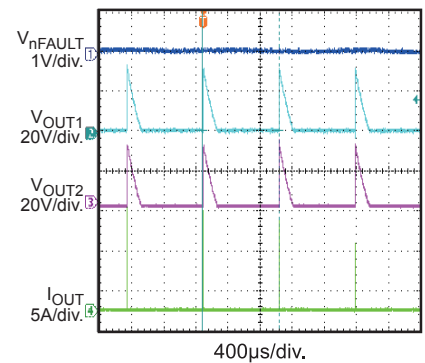

SCP

V_{IN} = 35V, OUT1 Short to GND

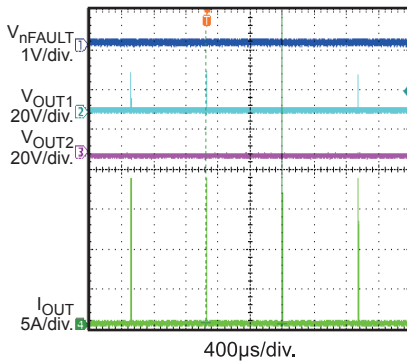

SCP

V_{IN} = 35V, OUT1 Short to V_{IN}

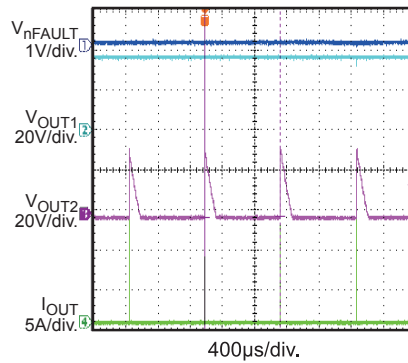

PIN FUNCTIONS

Pin #	Name	Description
1	IN1	Control inputs. IN1 and IN2 have internal pull-down resistors.
24	IN2	
2, 3, 16, 17	GND	System ground connection.
4	nSLEEP	Sleep mode input. Set nSLEEP to logic low to enter low-power sleep mode. nSLEEP has an internal pull-down resistor.
5, 20, 21, 22	NC	No connection.
6, 7	OUT1	Output terminal 1.
8	ISET	Current programming resistor. Connect a resistor from ISET to ground to set the current limit and VISEN output voltage.
9, 10, 11	VIN	Input supply voltage. Decouple VIN to GND with a ceramic capacitor $\geq 100\text{nF}$ to GND.
12, 13	OUT2	Output terminal 2.
14	CPA	Charge pump flying capacitor. Connect a 100nF ceramic capacitor between CPA and CPB.
15	CPB	
18	VCP	Charge pump output. Connect a 100nF capacitor from VCP to VIN.
19	VISEN	Current sense output voltage.
23	nFAULT	Fault indication. nFAULT is an open-drain output. nFAULT is at logic low when in a fault condition (OCP, OTP, OVP).
EP	GND	Exposed pad. The exposed pad must be connected to ground.

BLOCK DIAGRAM

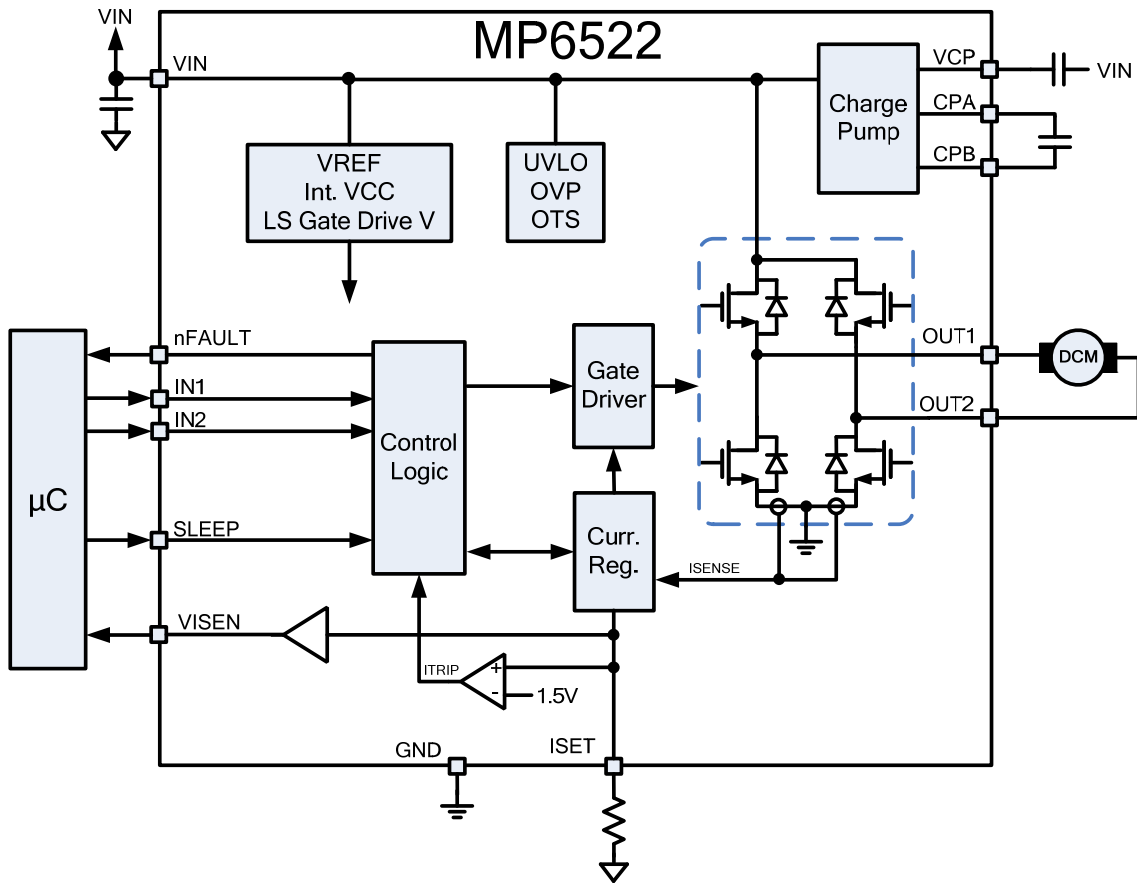

Figure 1: Functional Block Diagram

OPERATION

The MP6522 is an H-bridge motor driver that integrates four N-channel power MOSFETs with 3.2A of peak current capability. The MP6522 operates over a wide 5.4V to 35V input voltage range and is designed to drive DC brush motors, solenoids, and other loads.

Current Sensing

The current flowing in the two low-side MOSFETs is sensed with an internal current-sensing circuit. A voltage proportional to the output current is sourced on VISEN.

The VISEN output voltage scaling is set by a resistor connected between ISET and ground. For 1A of output current, 100 μ A of current is sourced into the resistor connected to ISET. For example, if a 10k Ω resistor is connected between ISET and ground, the output voltage on VISEN is 1V/A of output current.

The current is sensed when one of the low-side MOSFETs is turned on, including during slow decay (brake) mode.

The load current applied to VISEN should be kept below 2mA with no more than 500pF of capacitance.

Current Limit and Regulation

The current in the outputs is limited using constant-off-time pulse-width modulation (PWM) control circuitry.

In PWM, a diagonal pair of MOSFETs is turned on initially and drives current through the load. The current increases in the load, which is sensed by the internal current-sense circuit. If the load current reaches the current-trip threshold, the H-bridge switches to slow decay mode with the two low-side MOSFETs turned on.

After a fixed off-time (t_{TRIP}), if the load current falls at least 20% below the current-limit threshold, the MOSFETs are re-enabled and the cycle repeats. If the current is still higher than this level, the off time is extended until the current falls to 20% below the current limit threshold.

The current-limit threshold is reached when VISEN reaches 1.5V. For example, with a 10k Ω resistor from ISET to ground, the VISEN voltage is 1V/A of output current. Therefore, when the current reaches 1.5A, the VISEN voltage reaches 1.5V, and a current trip occurs.

During current regulation, nFAULT is not activated.

Blanking Time

There is often a current spike during start-up due to the body diode's reverse-recovery current or the shunt capacitance of the load. This current spike requires filtering to prevent it from erroneously shutting down the high-side MOSFET. An internal fixed blanking time (t_{OCPD}) blanks the output of the current-sense comparator when the outputs are switched. This blanking time also sets the minimum on time for the high-side MOSFET.

Input Logic

For the MP6522, control of the outputs is accomplished through IN1 and IN2 (see Table 1).

Table 1: Output Control Pins

IN1	IN2	OUT1	OUT2	Function
0	0	Z	Z	Coast
0	1	L	H	Forward
1	0	H	L	Reverse
1	1	L	L	Brake (low)

nSLEEP Operation

Driving nSLEEP low puts the device into a low-power sleep state. In this state, all internal circuits including the gate drive charge pump are disabled, and the H-bridge outputs are turned off. All inputs are ignored when nSLEEP is active low. When waking up from sleep mode, approximately 1ms of time must pass before the outputs can operate.

Fault

The MP6522 provides an nFAULT pin, which is driven active low if any protection circuits (over-current, over-voltage, over-temperature) are activated. nFAULT is not driven low when a current-limit trip occurs. nFAULT is an open-drain output and requires an external pull-up resistor. When the fault condition is removed, nFAULT is pulled inactive high by the pull-up resistor.

Over-Current Protection (OCP)

The over-current protection (OCP) circuit protects the device from damaging high currents at the outputs. If the current through a MOSFET exceeds the over-current threshold for longer than the over-current deglitch time, all MOSFETs in the H-bridge are disabled, and nFAULT is driven low. The driver remains disabled for the over-current retry time (t_{OCP}), at which point the driver is re-enabled automatically. Over-current conditions are sensed on both high- and low-side devices (i.e.: a short to ground, supply, or across the motor winding results in an over-current shutdown. Note that OCP does not use the current-sense circuitry used for PWM current control and is independent of the ISET resistor value.

Over-Voltage Protection (OVP)

If the input voltage applied to VIN is higher than the over-voltage protection (OVP) threshold, the H-bridge output is disabled, and nFAULT is driven low. This protection is released when VIN drops to a safe level.

Input Under-Voltage Lockout (UVLO) Protection

If at any time the voltage on VIN falls below the under-voltage lockout (UVLO) threshold, all circuitry in the device is disabled, and the internal logic is reset. Operation resumes when VIN rises above the UVLO threshold.

Thermal Shutdown

If the die temperature exceeds the safe limits, all MOSFETs in the H-bridge are disabled, and nFAULT is driven low. Once the die temperature has fallen to a safe level, operation resumes automatically.

PACKAGE INFORMATION

QFN-24 (5mmx5mm)

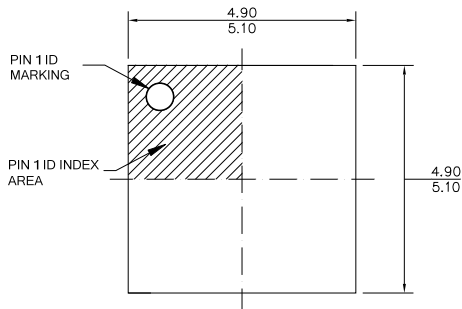

TOP VIEW

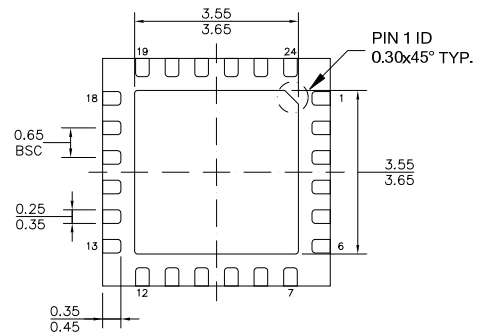

BOTTOM VIEW

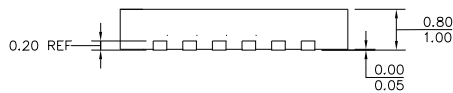

SIDE VIEW

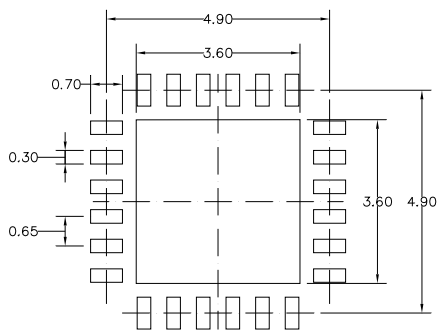

RECOMMENDED LAND PATTERN

NOTE:

- 1) ALL DIMENSIONS ARE IN MILLIMETERS.
- 2) EXPOSED PADDLE SIZE DOES NOT INCLUDE MOLD FLASH.
- 3) LEAD COPLANARITY SHALL BE 0.10 MILLIMETERS MAX.
- 4) DRAWING CONFIRMS TO JEDEC MO-220.
- 5) DRAWING IS NOT TO SCALE.

NOTICE: The information in this document is subject to change without notice. Please contact MPS for current specifications. Users should warrant and guarantee that third party Intellectual Property rights are not infringed upon when integrating MPS products into any application. MPS will not assume any legal responsibility for any said applications.