

DESCRIPTION

The MP6233 Power Distribution Switch features internal current limiting to prevent damage to host devices due to faulty load conditions. The MP6233 analog switch includes an 85mΩ power MOSFET switch. It is available with guaranteed current limits, making it ideal for load switching applications. The MP6233 has built-in protection for both over current and increased thermal stress. For over current, the device will limit the current by changing to a constant current mode.

As the temperature increases as a result of short circuit, the device will shut off. The device will recover once the device temperature reduces to approx 120°C.

The MP6233 is available in MSOP8E package.

FEATURES

- 1.5A Continuous Current
- 2.7V to 5.5V Supply Range
- 140uA Quiescent Current
- 85mΩ MOSFET
- Thermal-Shutdown Protection
- Under-Voltage Lockout
- 8ms FLAG Deglitch Time
- No FLAG Glitch During Power Up
- Reverse Current Blocking
- UL Recognized: E322138

APPLICATIONS

- Portable GPS Device
- Notebook PC
- LCD TV
- Set-top-box
- Telecom and Network Systems
- PC Card Hot Swap
- USB Power Distribution

All MPS parts are lead-free and adhere to the RoHS directive. For MPS green status, please visit MPS website under Quality Assurance. "MPS" and "The Future of Analog IC Technology" are Registered Trademarks of Monolithic Power Systems, Inc.

TYPICAL APPLICATION

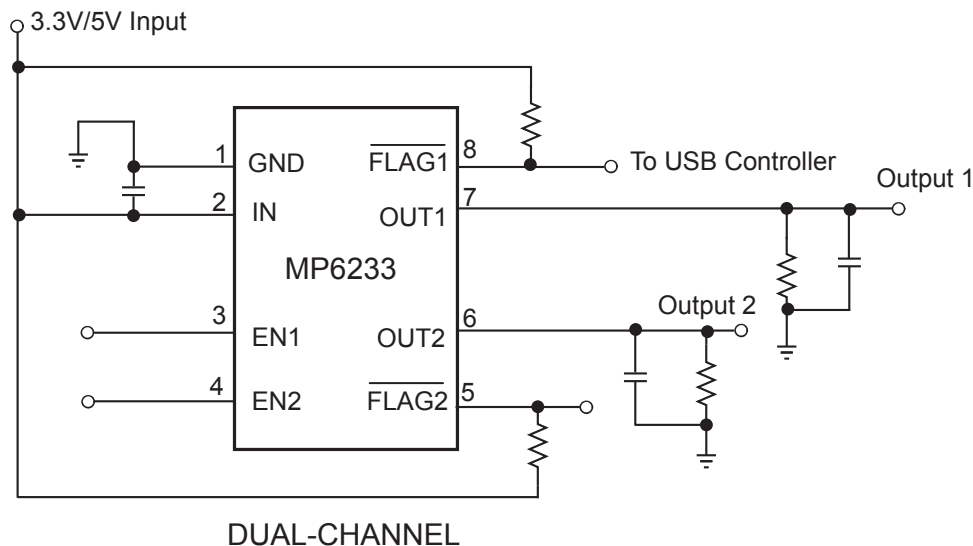

UL Recognized Component

ORDERING INFORMATION

Part Number	Enable	Switch	Maximum Continuous Load Current	Typical Short-Circuit Current @ T _A =25°C	Package	Top Marking	Temperature
MP6233DH	Active High	Dual	1.5A	2.3A	MSOP8E	6233D	-40°C to +85°C

For Tape & Reel, add suffix -Z (eg. MP6233DH-Z); For RoHS Compliant Packaging, add suffix -LF; (eg. MP6233DH-LF)

PACKAGE REFERENCE

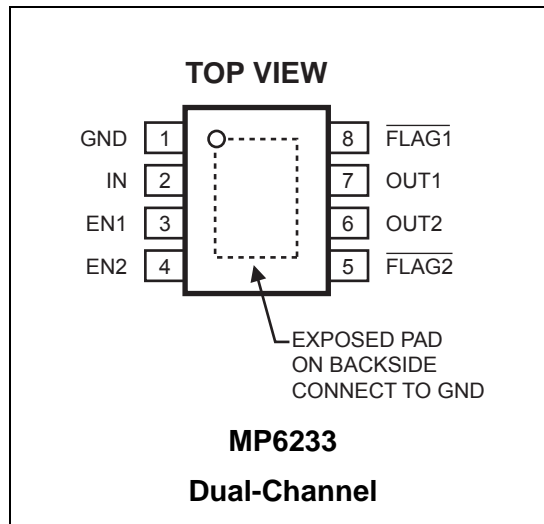

ABSOLUTE MAXIMUM RATINGS ⁽¹⁾

IN	-0.3V to +6.0V
EN, FLAG, OUT to GND	-0.3V to +6.0V
Junction Temperature	150°C
Lead Temperature	260°C
Storage Temperature	-65°C to +150°C
Operating Temperature	-40°C to +85°C

<i>Thermal Resistance</i> ⁽²⁾	θ_{JA}	θ_{JC}
MSOP8E	55	12... °C/W

Notes:

- 1) Exceeding these ratings may damage the device.
- 2) Measured on JESD51-7, 4-layer PCB.

ELECTRICAL CHARACTERISTICS ⁽³⁾
 $V_{IN}=5V$, $T_A=+25^{\circ}C$, unless otherwise noted.

Parameter	Condition	Min	Typ	Max	Units
IN Voltage Range		2.7		5.5	V
Supply Current	One Channel Enabled, $I_{OUT}=0$, One Switch ON		90	120	μA
Supply Current	Both Channels Enabled, $I_{OUT}=0$, Both Switch ON		140	160	μA
Shutdown Current	Device Disable, $V_{OUT}=float$, $V_{IN}=5.5V$		1		μA
Off Switch Leakage	Device Disable, $V_{IN}=5.5V$		1		μA
Current Limit		1.6	2.3	3	A
Trip Current	Current Ramp (slew rate $\leq 100A/s$) on Output		2.7	3.5	A
Under-voltage Lockout	Rising Edge	1.95		2.65	V
Under-voltage Hysteresis			250		mV
FET On Resistance	$I_{OUT}=100mA$ and $-40^{\circ}C < T_A < 85^{\circ}C$		85	130	m Ω
EN Input Logic High Voltage		2			V
EN Input Logic Low Voltage				0.4	V
FLAG Output Logic Low Voltage	$I_{SINK}=5mA$			0.4	V
FLAG Output High Leakage Current	$V_{IN}=V_{FLAG}=5.5V$			1	μA
Thermal Shutdown			140		$^{\circ}C$
Thermal Shutdown Hysteresis			20		$^{\circ}C$
V_{OUT} Rising Time, T_r	$V_{IN}=5.5V$, $CL=1\mu F$, $RL=5\Omega$		0.9		ms
	$V_{IN}=2.7V$, $CL=1\mu F$, $RL=5\Omega$		1.7		ms
V_{OUT} Falling Time, T_f	$V_{IN}=5.5V$, $CL=1\mu F$, $RL=5\Omega$			0.5	ms
	$V_{IN}=2.7V$, $CL=1\mu F$, $RL=5\Omega$			0.5	ms
Turn On Time, T_{on}	$C_L=100\mu F$, $RL=5\Omega$			3	ms
Turn Off Time, T_{off}	$C_L=100\mu F$, $RL=5\Omega$			10	ms
FLAG Deglitch Time		4	8	15	ms
ENx Input Leakage		-1			μA
Reverse Leakage Current	$OUTX=5.5V$, $IN=GND$		0.2		μA

NOTE:

 3) Production test at $+25^{\circ}C$. Specifications over the temperature range are guaranteed by design and characterization.

PIN FUNCTIONS

MSOP8E	Name	Description
1	GND, Exposed Pad	Ground. Connect exposed pad to GND plane for optimal thermal performance.
2	IN	Input Voltage. Accepts 2.7V to 5.5V input.
3	EN1	Active High
4	EN2	Active High
5	$\overline{\text{FLAG2}}$	IN-to-OUT2 Over-current, active-low output flag. Open-Drain.
6	OUT2	IN-to-OUT2 Power-Distribution Switch Output.
7	OUT1	IN-to-OUT1 Power-Distribution Switch Output
8	$\overline{\text{FLAG1}}$	IN-to-OUT1 Over-current, active-low output flag. Open-Drain.

TYPICAL PERFORMANCE CHARACTERISTICS

$T_A = +25^\circ\text{C}$, unless otherwise noted.

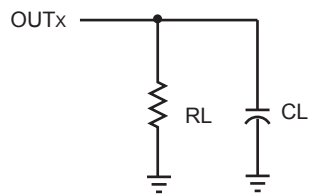

TEST CIRCUIT

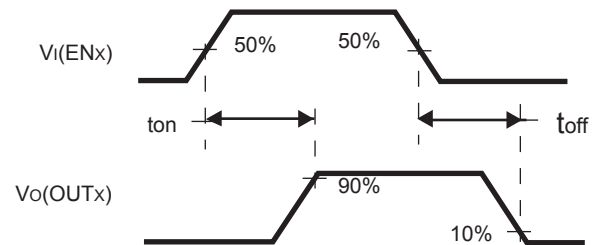
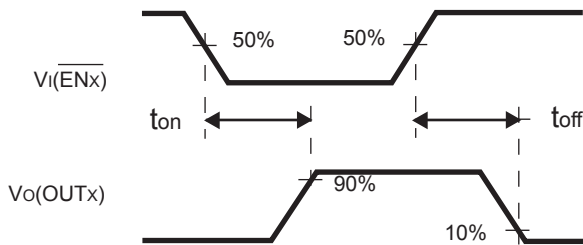
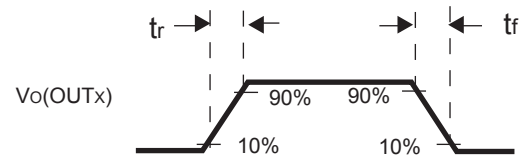

VOLTAGE WAVEFORMS

TYPICAL PERFORMANCE CHARACTERISTICS

$C_L = 2.2\mu\text{F}$, $V_{IN} = 5.5\text{V}$, $T_A = +25^\circ\text{C}$, unless otherwise noted.

Turn on Delay vs. Input Voltage

$V_{EN}=5\text{V}$, $R_L=3.3\Omega$

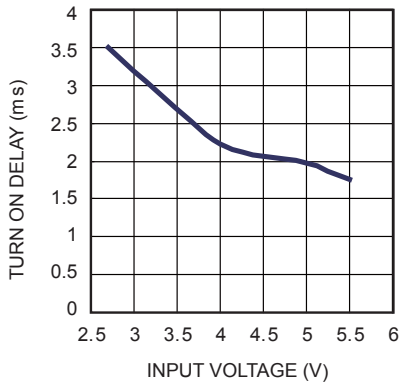

Turn off Delay vs. Input Voltage

$V_{EN}=5\text{V}$, $R_L=3.3\Omega$

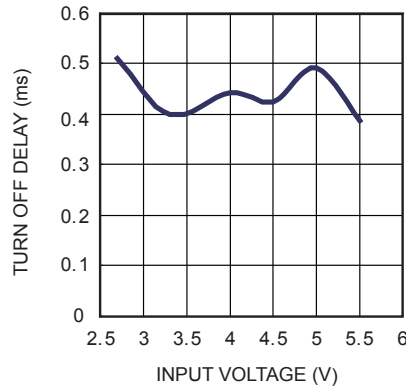

Supply Current, Output Enabled vs. Input Voltage

$V_{EN}=5\text{V}$

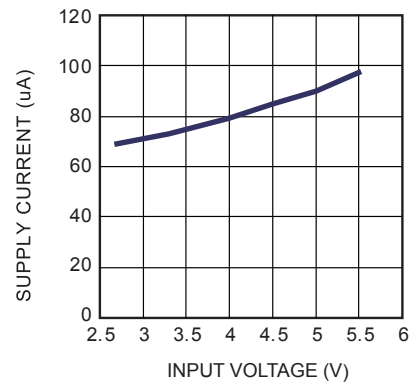

Static Drain-Source On-State Resistance Variation vs. Ambient Temperature

$V_{IN}=5\text{V}$, $I_O=0.1\text{A}$

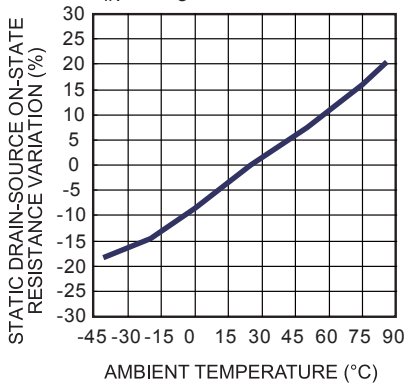

Static Drain-Source On-State Resistance vs. Input Voltage

$V_{EN}=5\text{V}$, $I_{OUT}=1.5\text{A}$

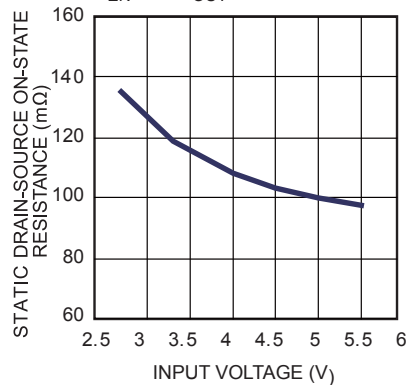

Input to Output Voltage vs. Load Current

$V_{EN}=5\text{V}$

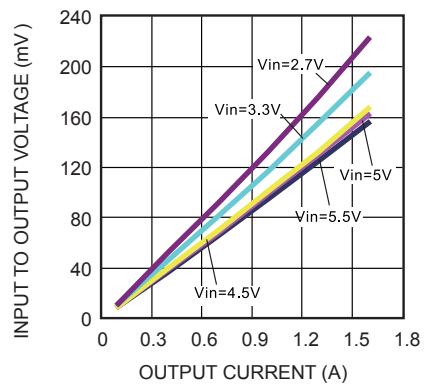

Current Limit vs. Input Voltage

$V_{EN}=5\text{V}$

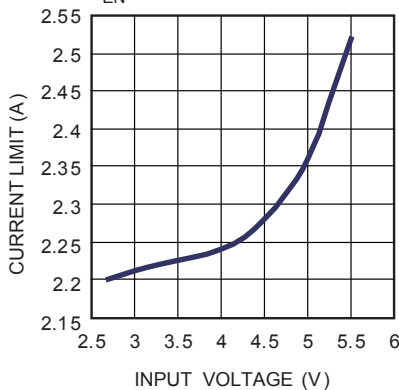

Threshold Trip Current vs. Input Voltage

$V_{EN}=5\text{V}$

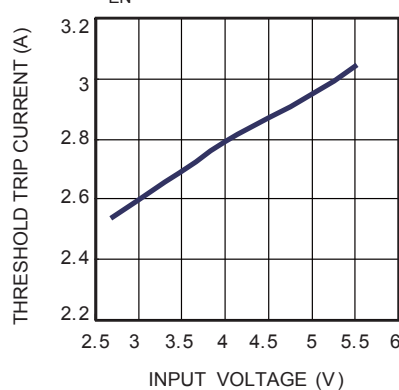

Current Limit Response vs. Peak Current

$V_{EN}=5\text{V}$

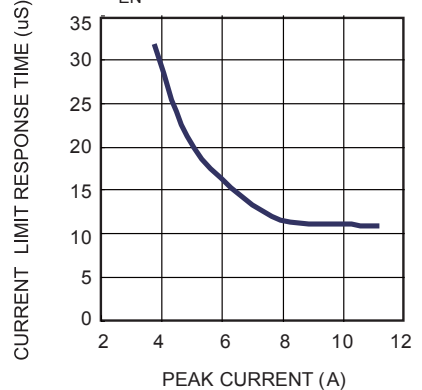

TYPICAL PERFORMANCE CHARACTERISTICS

$V_{IN} = 5.5V$, $T_A = +25^{\circ}C$, unless otherwise noted. (continued)

Turn On Delay and Rise Time with 0.1uF Load

$V_{EN}=5V, C_L=0.1\mu F$

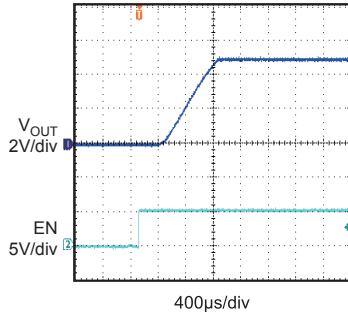

Turn Off Delay and Fall Time with 0.1uF Load

$V_{EN}=5V, C_L=0.1\mu F$

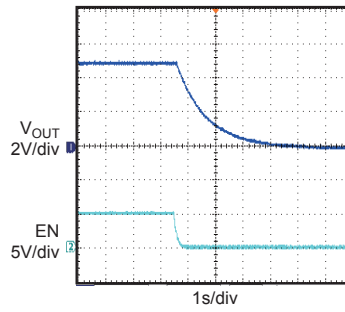

Turn On Delay and Rise Time

$V_{EN}=5V, R_L=3.3\Omega, C_L=2.2\mu F$

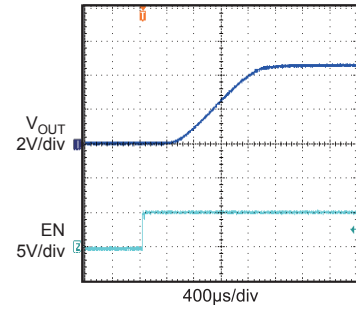

Turn Off Delay and Fall Time

$V_{EN}=5V, R_L=3.3\Omega, C_L=2.2\mu F$

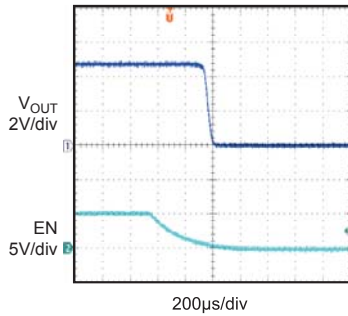

Short Circuit Current, Device Enabled into Short

$V_{EN}=5V, C_L=2.2\mu F$

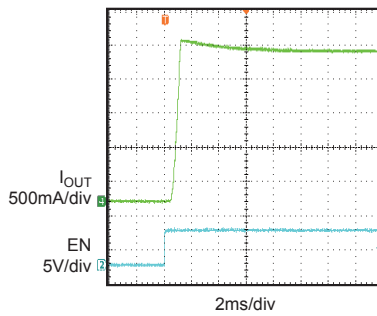

Threshold Trip Current with Ramped Load on Enabled Device

$V_{EN}=5V, C_L=2.2\mu F$

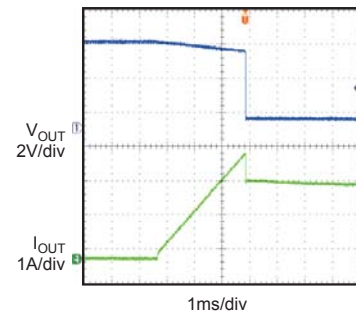

Ramped Load on Enabled Device

$V_{EN}=5V, C_L=2.2\mu F$

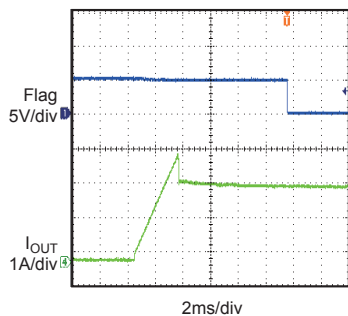

Inrush Current with Different Load Capacitance

$R_L=3.3\Omega, V_{EN}=5V$,
Start up by EN

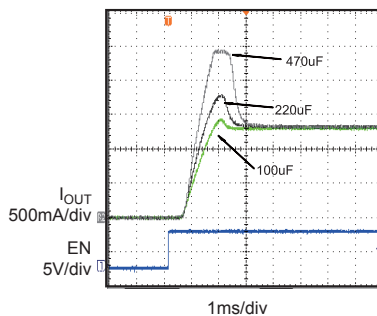

1Ω Load Connected to Enabled Device

$V_{EN}=5V, C_L=2.2\mu F$

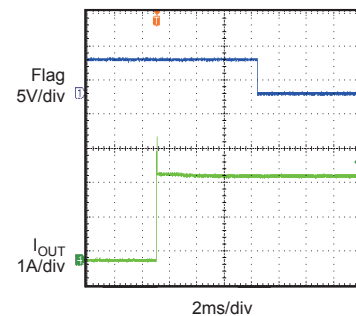

FUNCTION BLOCK DIAGRAM

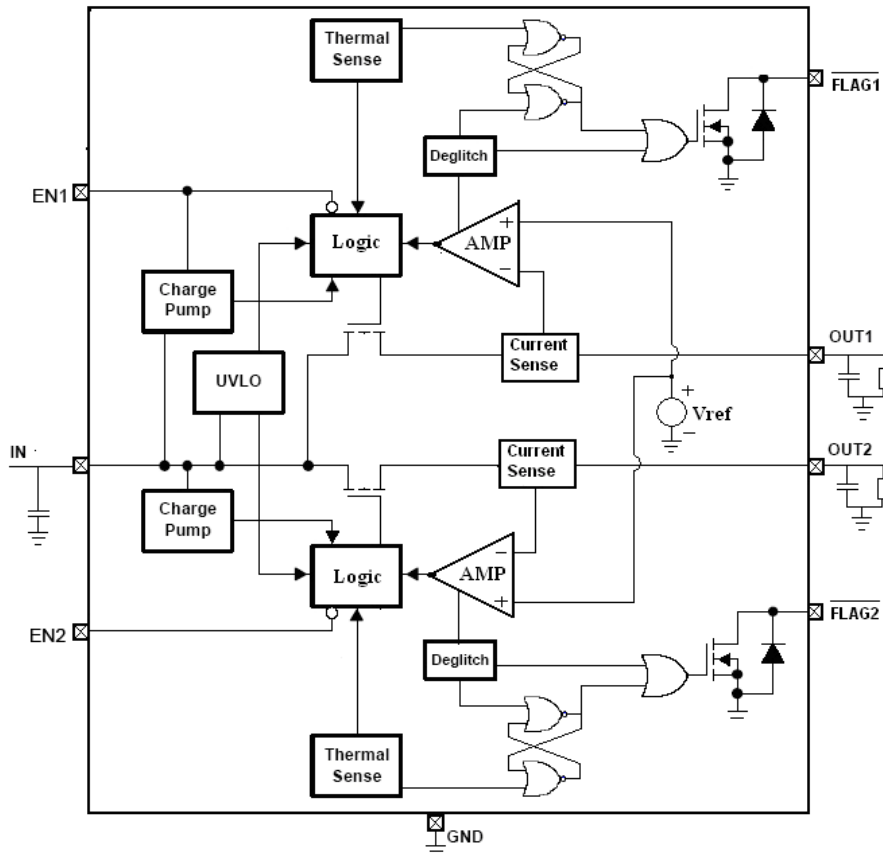

Figure1—Functional Block Diagram

DETAILED DESCRIPTION

Over Current

When the load exceeds trip current (minimum threshold current triggering constant-current mode) or a short is present, MP6233 switches into to a constant-current mode (current limit value). MP6233 will be shutdown only if the overcurrent condition stays long enough to trigger thermal protection.

Trigger overcurrent protection for different overload conditions occurring in applications:

- 1) The output has been shorted or overloaded before the device is enabled or input applied. MP6233 detects the short or overload and immediately switches into a constant-current mode.
- 2) A short or an overload occurs after the device is enabled. After the current-limit circuit has been tripped (reached the trip current threshold), the device switches into constant-

current mode. However, high current may flow for a short period of time before the current-limit circuit can react.

- 3) Output current has been gradually increased beyond the recommended operating current. The load current rises until the trip current threshold is reached or until the thermal limit of the device is exceeded. The MP6233 is capable of delivering current up to the trip current threshold without damaging the device. Once the trip threshold has been reached, the device switches into its constant-current mode.

Flag Response

The FLAG pin is an open drain configuration. This FAULT will report a fail mode after an 8ms deglitch timeout. This is used to ensure that no false fault signals are reported. This internal deglitch circuit eliminates the need for extend components. The FLAG pin is not deglitched during an over temp. or a voltage lockout.

Thermal Protection

The purpose of thermal protection is to prevent damage in the IC by allowing excessive current to flow and heating the junction. The die temp. is internally monitored until the thermal limit is reached. Once this temp. is reached, the switch will turn off and allow the chip to cool. The switch has a built-in hysteresis.

Under-voltage Lockout (UVLO)

This circuit is used to monitor the input voltage to ensure that the MP6233 is operating correctly. This UVLO circuit also ensures that there is no

operation until the input voltage reaches the minimum spec.

Enable

The logic pin disables the chip to reduce the supply current. The device will operate once the enable signal reaches the appropriate level. The input is compatible with both COMS and TTL.

APPLICATION INFORMATION

Power-Supply Considerations

Over 10 μ F capacitor between IN and GND is recommended.

This precaution reduces power-supply transients that may cause ringing on the input and improves the immunity of the device to short-circuit transients.

In order to achieve smaller output load transient ripple, placing a high-value electrolytic capacitor on the output pin(s) is recommended when the load is heavy.

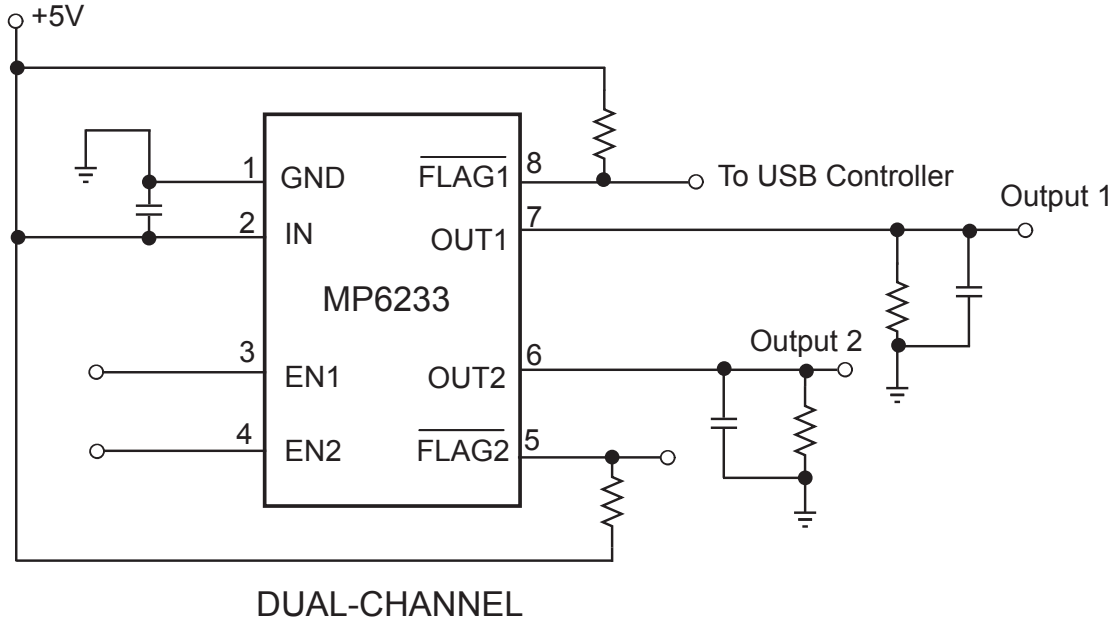
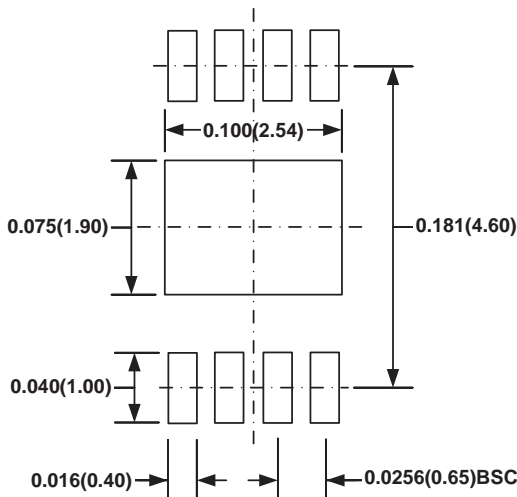
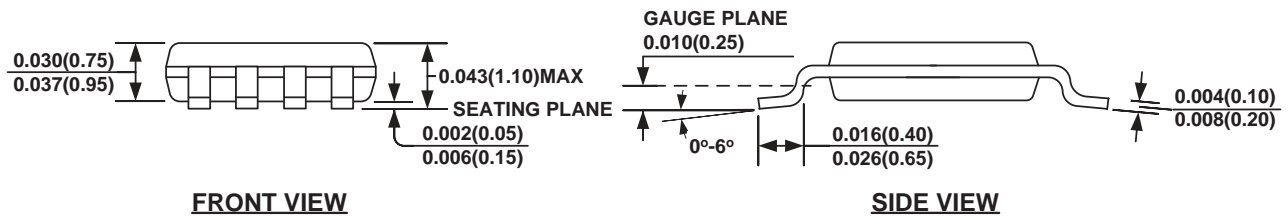
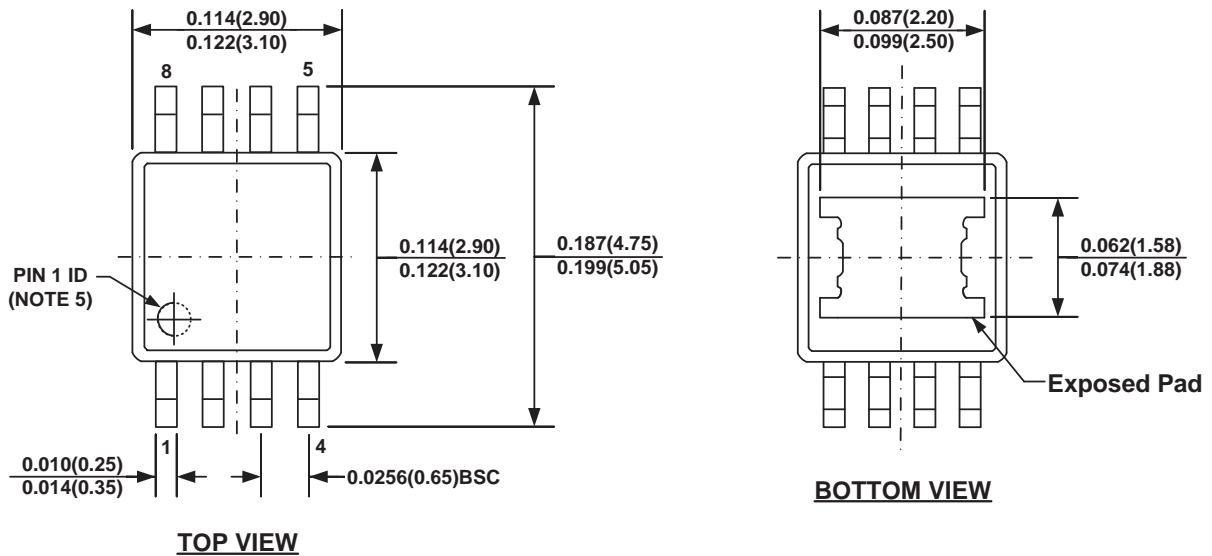

Figure2—Application Circuit

PACKAGE INFORMATION
MSOP8E (EXPOSED PAD)

NOTE:

- 1) CONTROL DIMENSION IS IN INCHES. DIMENSION IN BRACKET IS IN MILLIMETERS.
- 2) PACKAGE LENGTH DOES NOT INCLUDE MOLD FLASH, PROTRUSION OR GATE BURR.
- 3) PACKAGE WIDTH DOES NOT INCLUDE INTERLEAD FLASH OR PROTRUSION.
- 4) LEAD COPLANARITY (BOTTOM OF LEADS AFTER FORMING) SHALL BE 0.004" INCHES MAX.
- 5) PIN 1 IDENTIFICATION HAS HALF OR FULL CIRCLE OPTION.
- 6) DRAWING MEETS JEDEC MO-187, VARIATION AA-T.
- 7) DRAWING IS NOT TO SCALE.

NOTICE: The information in this document is subject to change without notice. Users should warrant and guarantee that third party Intellectual Property rights are not infringed upon when integrating MPS products into any application. MPS will not assume any legal responsibility for any said applications.