

### DESCRIPTION

The MP6211-3/MP6212-3 single-channel Power Distribution Switch features internal current limiting to prevent damage to host devices due to faulty load conditions. The MP6211-3/MP6212-3 Analog switch has 95mΩ on-resistance and operates from 2.7V to 5.5V input. It is available with guaranteed current limits, making it ideal for load switching applications. The MP6211-3/MP6212-3 has built-in protection for both over current and increased thermal stress. For over current, the device will limit the current by changing to a constant current mode.

As the temperature increases as a result of short circuit, the device will shut off. The device will recover once the device temperature reduces to approx 120°C.

The FLAG output of MP6211-3/MP6212-3 will report a fail mode (low level) when over current or over temperature is encountered. The FLAG will not change state when the input UVLO is triggered.

The MP6211-3/MP6212-3 is available in 8-Pin MSOP package with exposed pad and 8-Pin SOIC8 package with exposed pad.

### FEATURES

- 1A Continuous Current
- Accurate Current Limit
- 2.7V to 5.5V Supply Range
- 90uA Quiescent Current
- 95mΩ MOSFET
- Thermal-Shutdown Protection
- Under-Voltage Lockout
- 8ms FLAG Deglitch Time
- FLAG Won't Change State At Input UVLO Transition
- Reverse Current Blocking
- Active High & Active Low Options
- SOIC8E and MSOP8E Packages

### APPLICATIONS

- Smartphone and PDA
- Portable GPS Device
- Notebook PC
- Set-top-box
- Telecom and Network Systems
- USB Power Distribution

For MPS green status, please visit MPS website under Quality Assurance. "MPS" and "The Future of Analog IC Technology" are Trademarks of Monolithic Power Systems, Inc.

### TYPICAL APPLICATION

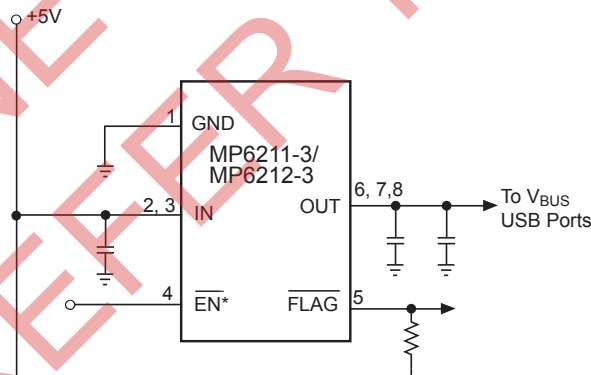

\*EN is active high for MP6211-3 SINGLE-CHANNEL

### ORDERING INFORMATION

Part Number	Enable	Switch	Maximum Continuous Load Current	Typical Short-Circuit Current @ T <sub>A</sub> =25°C	Package	Top Marking	Free Air Temperature (T <sub>A</sub> )
MP6212DN-3	Active Low	Single	1.0A	1.5A	SOIC8E	MP6212-3	-40°C to +85°C
MP6212DH-3					MSOP8E	M6212-3	
MP6211DN-3	Active High				SOIC8E	MP6211-3	
MP6211DH-3*					MSOP8E	M6211-3	

\* For Tape & Reel, add suffix –Z (e.g. MP6211DH-3–Z).  
 For RoHS Compliant Packaging, add suffix –LF (e.g. MP6211DH-3–LF–Z)

### PACKAGE REFERENCE

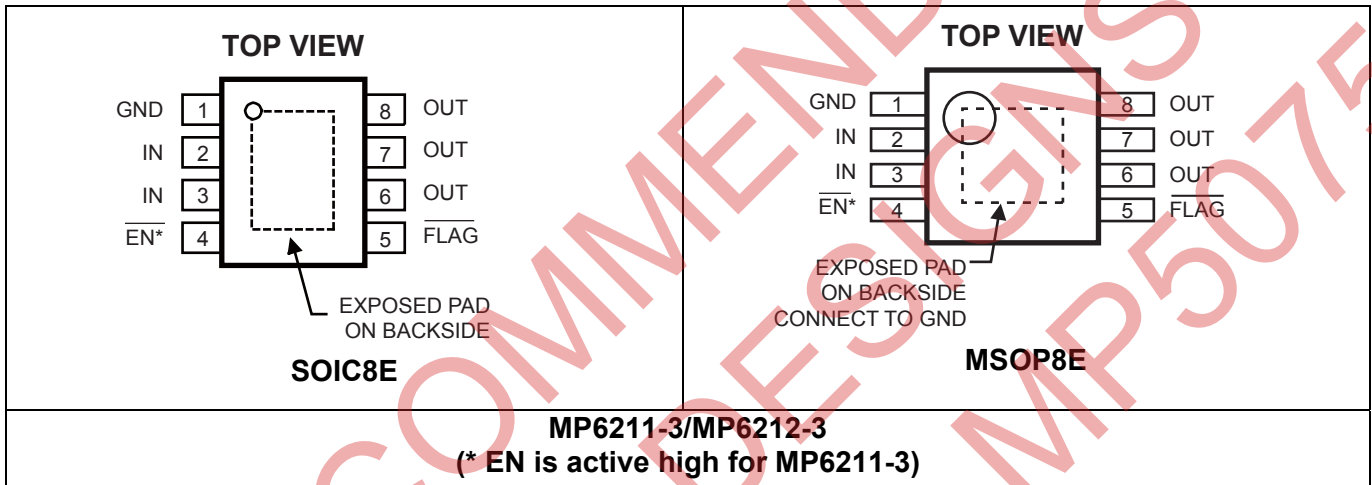

#### ABSOLUTE MAXIMUM RATINGS <sup>(1)</sup>

IN .....	-0.3V to +6.0V
EN, FLAG, OUT to GND .....	-0.3V to +6.0V
Continuous Power Dissipation. (T <sub>A</sub> = +25°C) <sup>(2)</sup>	
SOIC8E .....	2.5W
MSOP8E .....	2.3W
Junction Temperature .....	150°C
Lead Temperature .....	260°C
Storage Temperature .....	-65°C to +150°C
Maximum Junction Temp. (T <sub>J</sub> ) .....	+125°C

#### Thermal Resistance <sup>(3)</sup>

	$\theta_{JA}$	$\theta_{JC}$
SOIC8E .....	50	10... °C/W
MSOP8E .....	55	12... °C/W

#### Notes:

- Exceeding these ratings may damage the device.
- The maximum allowable power dissipation is a function of the maximum junction temperature T<sub>J</sub> (MAX), the junction-to-ambient thermal resistance  $\theta_{JA}$ , and the ambient temperature T<sub>A</sub>. The maximum allowable continuous power dissipation at any ambient temperature is calculated by P<sub>D</sub> (MAX) = (T<sub>J</sub> (MAX) - T<sub>A</sub>) /  $\theta_{JA}$ . Exceeding the maximum allowable power dissipation will cause excessive die temperature, and the regulator will go into thermal shutdown. Internal thermal shutdown circuitry protects the device from permanent damage.
- Measured on JESD51-7 4-layer PCB.

**ELECTRICAL CHARACTERISTICS** <sup>(4)</sup> $V_{IN}=5V$ ,  $T_A=+25^{\circ}C$ , unless otherwise noted.

Parameter	Condition	Min	Typ	Max	Units
IN Voltage Range		2.7		5.5	V
Supply Current	Single Channel	70	90	120	$\mu A$
Shutdown Current	Device Disable, $V_{OUT}=float$ , $V_{IN}=5.5V$			1	$\mu A$
Off Switch Leakage	Device Disable, $V_{IN}=5.5V$			1	$\mu A$
Current Limit		1.1	1.5	2.2	A
Trip Current	Current Ramp (slew rate $\leq 100A/s$ ) on Output		1.7	2.4	A
Under-voltage Lockout	Rising Edge	1.95		2.65	V
Under-voltage Hysteresis			250		mV
FET On Resistance	$I_{OUT}=100mA$ ( $-40^{\circ}C \leq T_A \leq +85^{\circ}C$ )		95	140	m $\Omega$
EN Input Logic High Voltage		2			V
EN Input Logic Low Voltage				0.8	V
FLAG Output Logic Low Voltage	$I_{SINK}=5mA$			0.4	V
FLAG Output High Leakage Current	$V_{IN}=V_{FLAG}=5.5V$			1	$\mu A$
Thermal Shutdown			140		$^{\circ}C$
Thermal Shutdown Hysteresis			20		$^{\circ}C$
$V_{OUT}$ Rising Time, $T_r$ <sup>(5)</sup>	$V_{IN}=5.5V$ , $C_L=1\mu F$ , $R_L=5.5\Omega$		0.9	2	ms
	$V_{IN}=2.7V$ , $C_L=1\mu F$ , $R_L=5.5\Omega$		1.7	3	ms
$V_{OUT}$ Falling Time, $T_f$ <sup>(6)</sup>	$V_{IN}=5.5V$ , $C_L=1\mu F$ , $R_L=5.5\Omega$		0.05	0.5	ms
	$V_{IN}=2.7V$ , $C_L=1\mu F$ , $R_L=5.5\Omega$		0.04	0.5	ms
Turn On Time, $T_{on}$ <sup>(7)</sup>	$C_L=100\mu F$ , $R_L=5.5\Omega$		1.9	3	ms
Turn Off Time, $T_{off}$ <sup>(8)</sup>	$C_L=100\mu F$ , $R_L=5.5\Omega$		1.3	10	ms
FLAG Deglitch Time		4	8	15	ms
EN Input Leakage			1		$\mu A$
Reverse Leakage Current	$V_{OUT}=5.5V$ , $V_{IN}=0$		0.1	1	$\mu A$

**Notes:**

- 4) Production test at  $+25^{\circ}C$ . Specifications over the temperature range are guaranteed by design and characterization.
- 5) Measured from 10% to 90%.
- 6) Measured from 90% to 10%.
- 7) Measured from (50%) EN signal to (90%) output signal.
- 8) Measured from (50%) EN signal to (10%) output signal.

**PIN FUNCTIONS**

SOIC8E	MSOP8E	Name	Description
1	1	GND	Ground.
2, 3	2, 3	IN	Input Voltage. Accepts 2.7V to 5.5V input.
4	4	$\overline{\text{EN}}$	Enable Input, Active Low: (MP6212-3), Active High: (MP6211-3)
5	5	$\overline{\text{FLAG}}$	Open-Drain. Flag output stays low after a short output or thermal current limit, and will not change state when input UVLO is triggered.
6, 7, 8	6, 7, 8	OUT	Power-Distribution Switch Output.

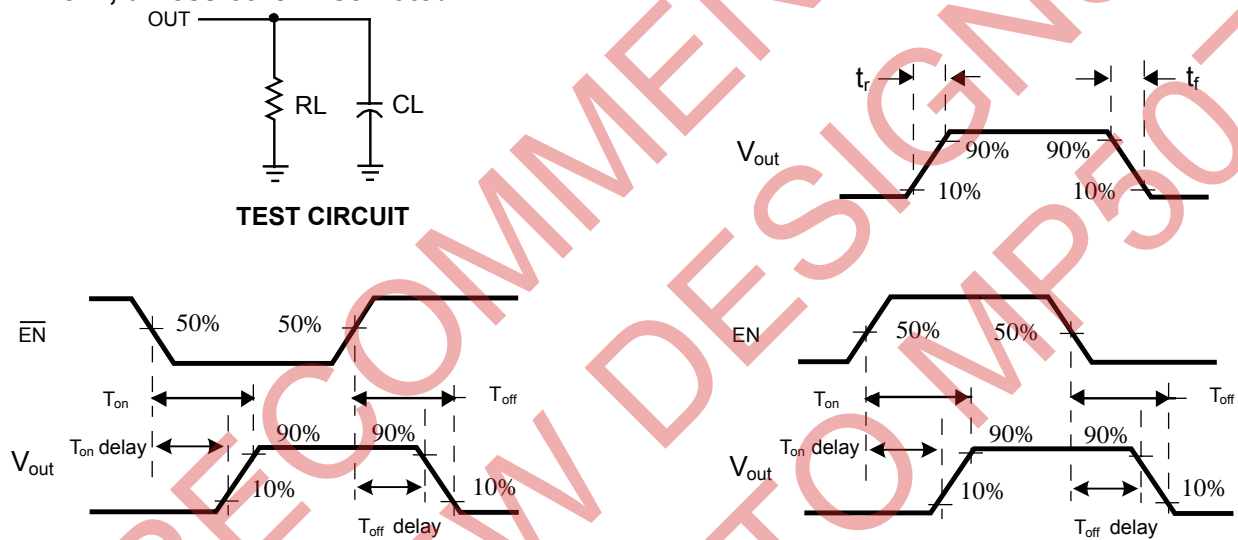
**TYPICAL PERFORMANCE CHARACTERISTICS**
 $T_A = +25^\circ\text{C}$ , unless otherwise noted.

**Figure 1—Test Circuit and Voltage Waveforms**

## TYPICAL PERFORMANCE CHARACTERISTICS

$V_{IN}=5.5V$ ,  $T_A=+25^{\circ}C$ , unless otherwise noted.

**Turn on Delay vs. Input Voltage**

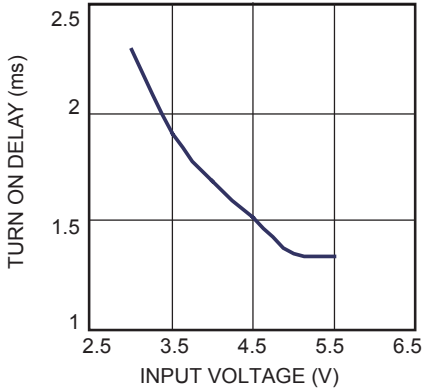
$V_{EN}=5V$ ,  $R_L=5.5\Omega$ ,  $C_L=2.2\mu F$



**Turn off Delay vs. Input Voltage**

$V_{EN}=5V$ ,  $R_L=5.5\Omega$ ,  $C_L=2.2\mu F$

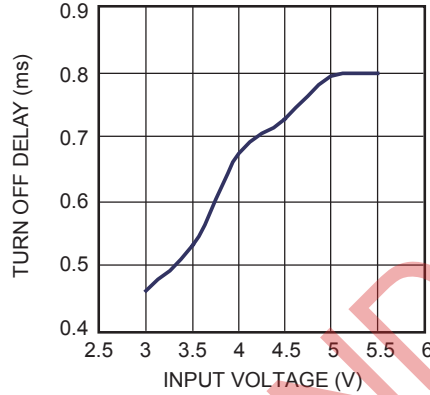

**Rise Time vs. Input Voltage**

$C_L=1\mu F$ ,  $I_{OUT}=1A$

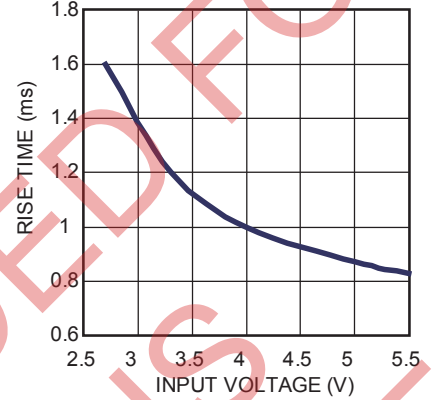

**Fall Time vs. Input Voltage**

$C_L=1\mu F$ ,  $I_{OUT}=1A$

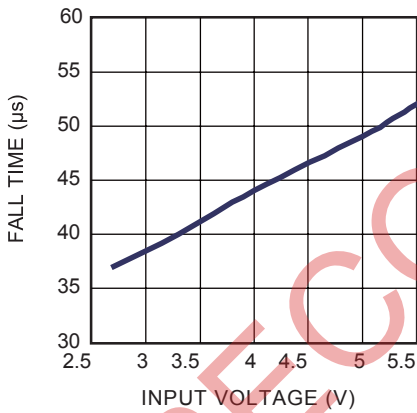

**Supply Current, Output Enabled vs. Input Voltage**

$V_{EN}=5V$ ,  $C_L=2.2\mu F$

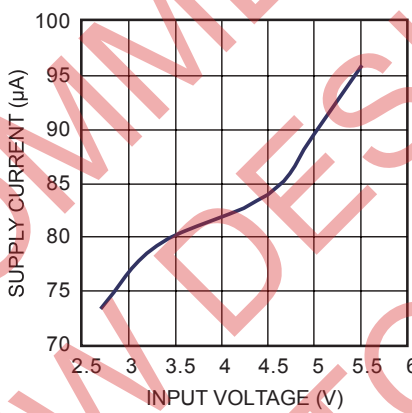

**Static Drain-Source On-State Resistance Variation vs. Ambient Temperature**

$V_{IN}=5V$ ,  $I_O=0.1A$ ,  $C_L=2.2\mu F$

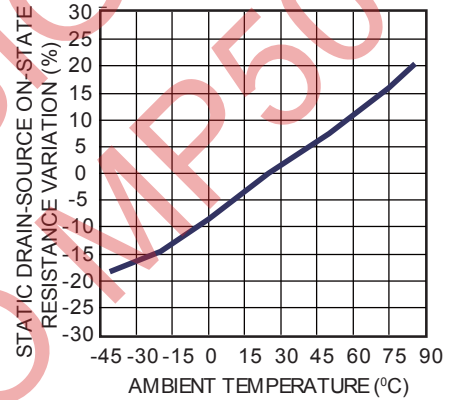

**Static Drain-Source On-State Resistance vs. Output Current**

$V_{IN}=5V$ ,  $V_{EN}=5V$ ,  $C_L=2.2\mu F$

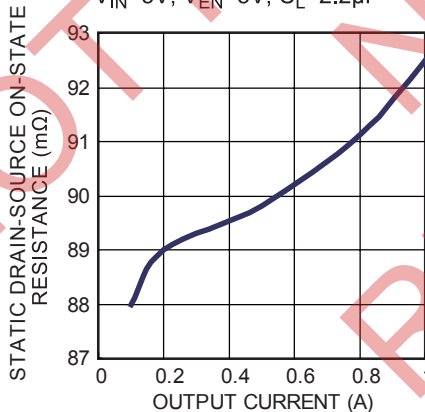

**Static Drain-Source On-State Resistance vs. Input Voltage**

$V_{EN}=5V$ ,  $I_{OUT}=0.1A$ ,  $C_L=2.2\mu F$

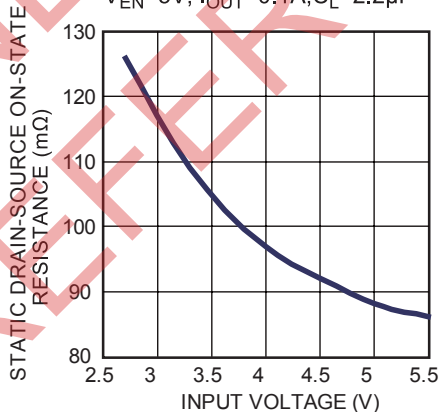

**Input to Output Voltage vs. Load Current**

$V_{EN}=5V$ ,  $C_L=2.2\mu F$

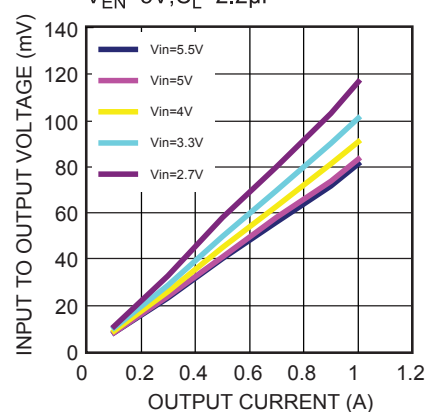

**TYPICAL PERFORMANCE CHARACTERISTICS (continued)**
 $V_{IN}=5.5V, T_A = +25^{\circ}C$ , unless otherwise noted.

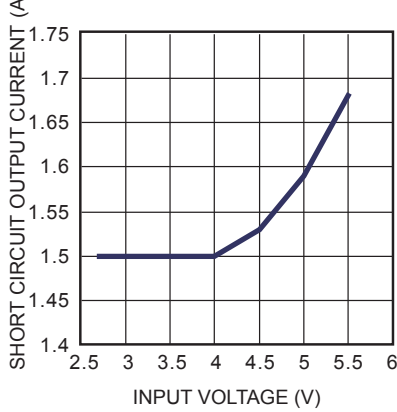
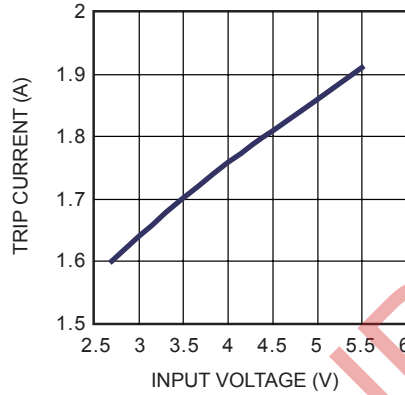
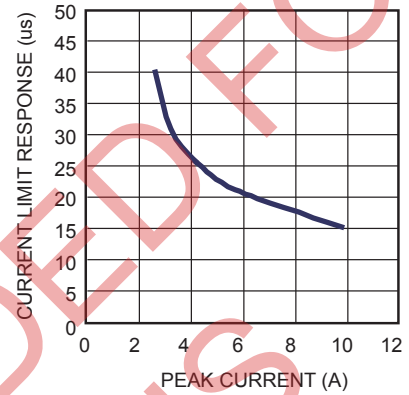
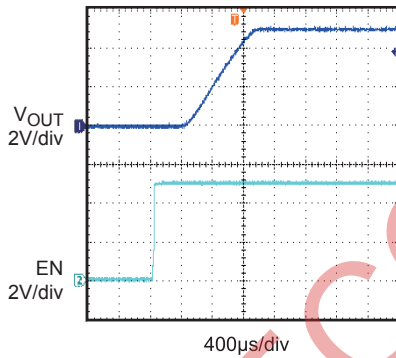
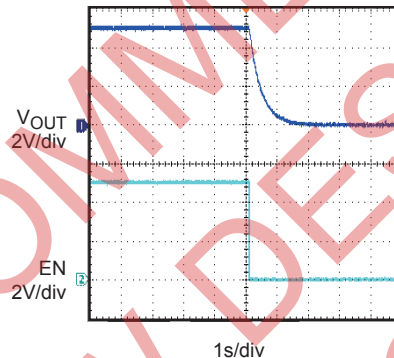
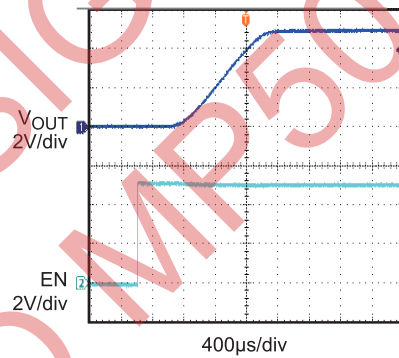
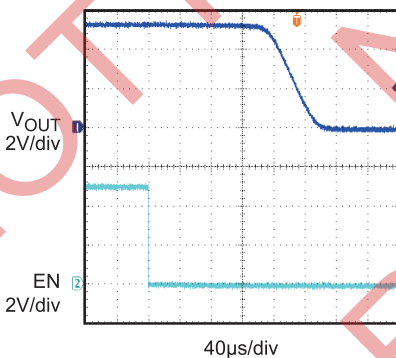
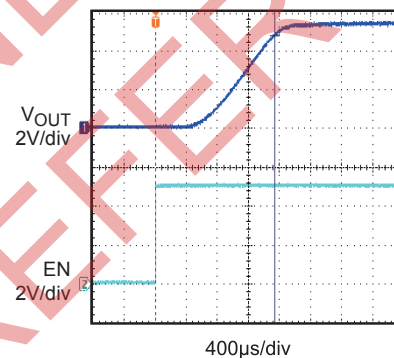
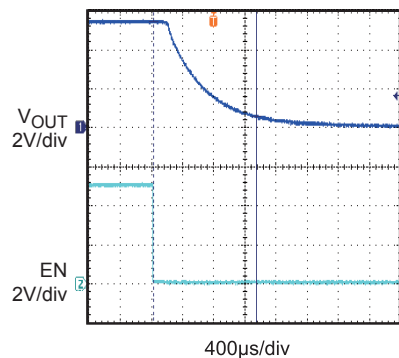
**Short Circuit Output Current vs. Input Voltage**
 $V_{EN}=5V, V_{IN}=5V, C_L=2.2\mu F$ 

**Threshold Trip Current vs. Input Voltage**
 $V_{EN}=5V, C_L=2.2\mu F$ 

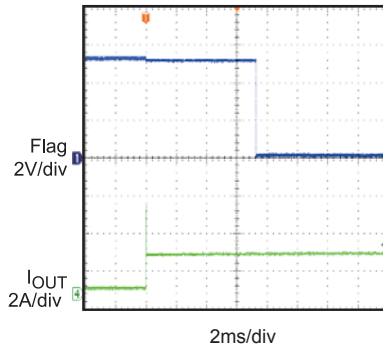
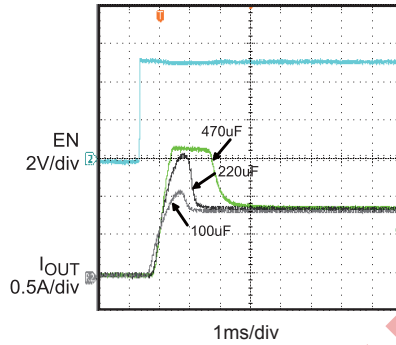
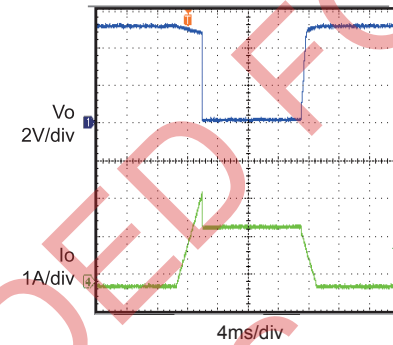
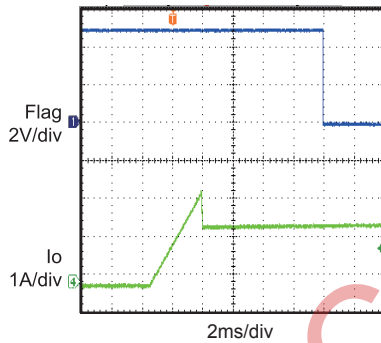
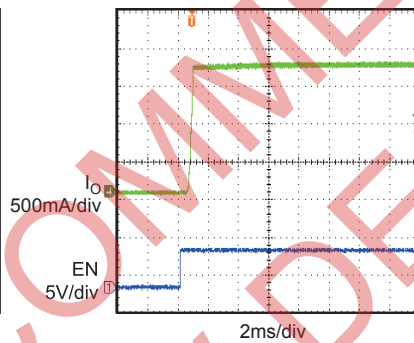
**Current Limit Response Time vs. Peak Current**
 $V_{EN}=5V, C_L=2.2\mu F$ 

**Turn On Delay and Rise Time with 0.1μF Load**
 $V_{EN}=5V, C_L=0.1\mu F$ 

**Turn Off Delay and Fall Time with 0.1μF Load**
 $V_{EN}=5V, C_L=0.1\mu F$ 

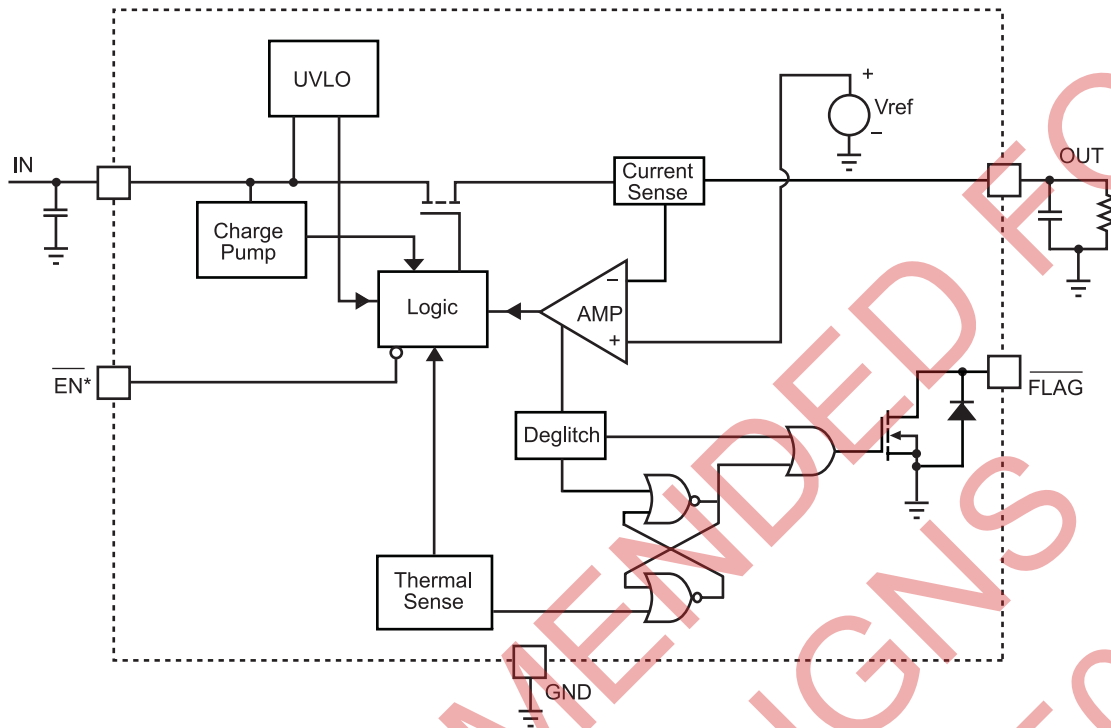
**Turn on Delay and Rise Time with 1μF Load**
 $V_{EN}=5V, R_L=5.5\Omega, C_L=1\mu F$ 

**Turn off Delay and Fall Time with 1μF Load**
 $V_{EN}=5V, R_L=5.5\Omega, C_L=1\mu F$ 

**Turn On Delay and Rise Time with 100μF Load**
 $V_{EN}=5V, R_L=5.5\Omega, C_L=100\mu F$ 

**Turn Off Delay and Fall Time with 100μF Load**
 $V_{EN}=5V, R_L=5.5\Omega, C_L=100\mu F$ 

**TYPICAL PERFORMANCE CHARACTERISTICS** *(continued)*
 $V_{IN}=5.5V$ ,  $T_A = +25^{\circ}C$ , unless otherwise noted.

**1Ω Load Connected to Enabled Device**
 $V_{EN}=5V$ ,  $C_L=1\mu F$ 

**Inrush Current with Different Load Capacitance**
 $V_{EN}=5V$ ,  $R_L=5.5\Omega$ , Start up by EN

**Threshold Trip Current with Ramped Load on Enabled Device**
 $V_{EN}=5V$ ,  $C_L=1\mu F$ 

**Ramped Load on Enabled Device**
 $V_{EN}=5V$ ,  $C_L=1\mu F$ 

**Short Circuit Current, Device Enabled into Short**
 $V_{EN}=5V$ ,  $C_L=1\mu F$ 



FUNCTION BLOCK DIAGRAM



\*EN is active high for MP6211-3

Figure 2—Function Block Diagram



## DETAILED DESCRIPTION

### Over Current

When the load exceeds trip current (minimum threshold current triggering constant-current mode) or a short is present, MP6211-3/MP6212-3 switches into to a constant-current mode (current limit value). MP6211-3/MP6212-3 will be shutdown only if the overcurrent condition stays long enough to trigger thermal protection.

Trigger overcurrent protection for different overload conditions occurring in applications:

- 1) The output has been shorted or overloaded before the device is enabled or input applied. MP6211-3/MP6212-3 detects the short or overload and immediately switches into a constant-current mode.
- 2) A short or an overload occurs after the device is enabled. After the current-limit circuit has been tripped (reached the trip current threshold), the device switches into constant-current mode. However, high current may flow for a short period of time before the current-limit circuit can react.
- 3) Output current has been gradually increased beyond the recommended operating current. The load current rises until the trip current threshold is reached or until the thermal limit of the device is exceeded. The MP6211-3/MP6212-3 is capable of delivering current up to the trip current threshold without damaging the device. Once the trip threshold has been reached, the device switches into its constant-current mode.

### Flag Response

The FLAG pin is an open drain configuration. When over current or over temperature is encountered, FLAG will report a fail mode (low level).

For over current, 8ms deglitch time-out is needed. This is used to ensure that no false fault signal is reported. This internal deglitch circuit eliminates the need for components. For over temperature, the FLAG pin is not deglitched.

When the device recovers from over temperature protection and enters over current mode, the FLAG remains low if  $V_{OUT}$  is less than 1.4V (Figure 3). Otherwise FLAG will become low after 8ms deglitch time (Figure 4).

The FLAG will not change state when the input UVLO is triggered.

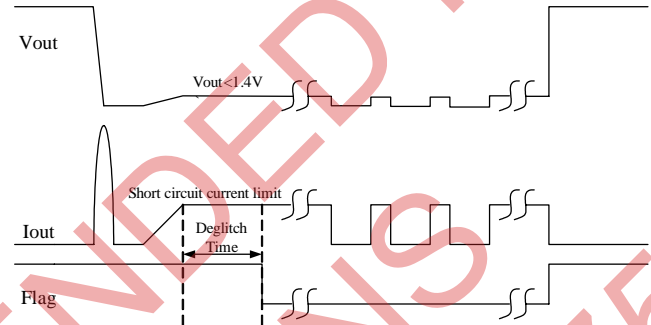

**Figure 3—Flag Indication When Short Output to Ground**

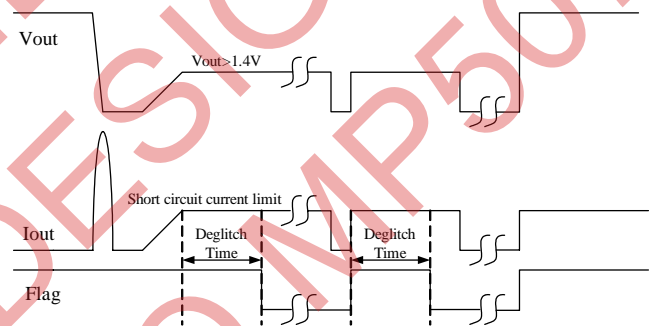

**Figure 4—Flag Indication When Short with 1Ω Resistor**

### Thermal Protection

The purpose of thermal protection is to prevent damage in the IC by allowing excessive current to flow and heating the junction. The die temp. is internally monitored until the thermal limit is reached. Once this temp. is reached, the switch will turn off and allow the chip to cool. The switch has a built-in hysteresis.

### Under-voltage Lockout (UVLO)

This circuit is used to monitor the input voltage to ensure that the MP6211-3/MP6212-3 is operating correctly. This UVLO circuit also ensures that there is no operation until the input voltage reaches the minimum spec.

**Enable**

The logic pin disables the chip to reduce the supply current. The device will operate once the enable signal reaches the appropriate level. The input is compatible with both COMS and TTL.

NOT RECOMMENDED FOR  
NEW DESIGNS  
REFER TO MP5075L

**APPLICATION INFORMATION**

**Power-Supply Considerations**

Over 10µF capacitor between IN and GND is recommended. This precaution reduces power-supply transients that may cause ringing on the input and improves the immunity of the device to short-circuit transients.

In order to achieve smaller output load transient ripple, placing a high-value electrolytic capacitor on the output pin(s) is recommended when the load is heavy.

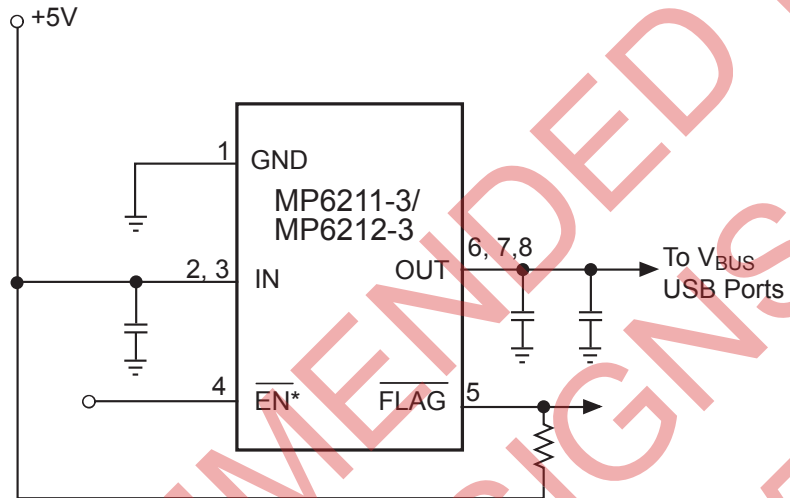

\*EN is active high for MP6211-3 SINGLE-CHANNEL

**Figure 5—Application Circuit**

PACKAGE INFORMATION

MSOP8E (EXPOSED PAD)

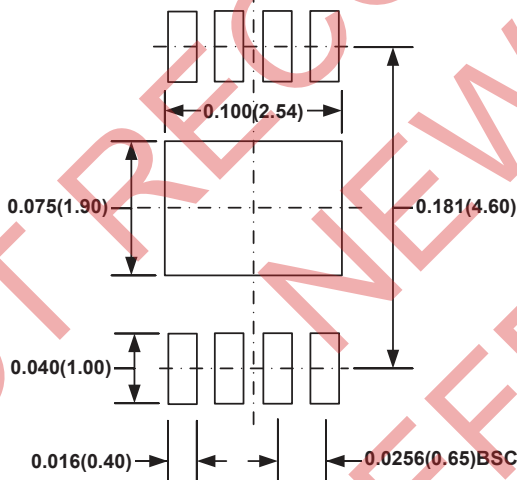
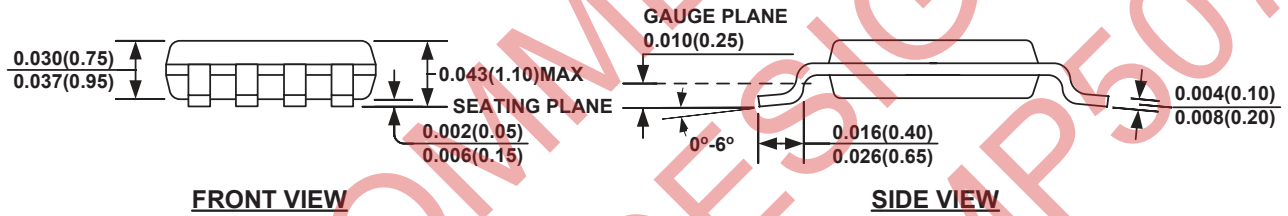
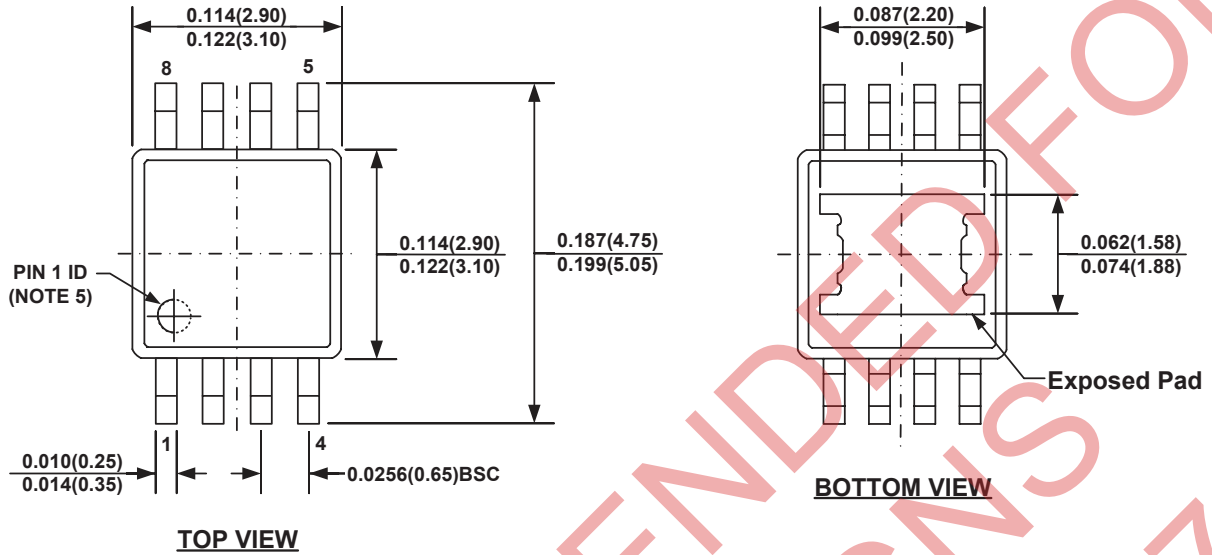

**NOTE:**

- 1) CONTROL DIMENSION IS IN INCHES. DIMENSION IN BRACKET IS IN MILLIMETERS.
- 2) PACKAGE LENGTH DOES NOT INCLUDE MOLD FLASH, PROTRUSION OR GATE BURR.
- 3) PACKAGE WIDTH DOES NOT INCLUDE INTERLEAD FLASH OR PROTRUSION.
- 4) LEAD COPLANARITY (BOTTOM OF LEADS AFTER FORMING) SHALL BE 0.004" INCHES MAX.
- 5) PIN 1 IDENTIFICATION HAS HALF OR FULL CIRCLE OPTION.
- 6) DRAWING MEETS JEDEC MO-187, VARIATION AA-T.
- 7) DRAWING IS NOT TO SCALE.

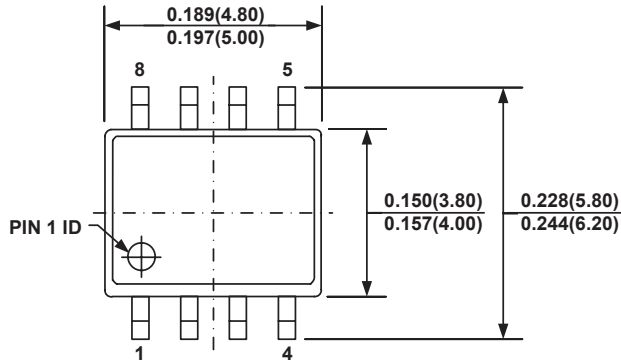
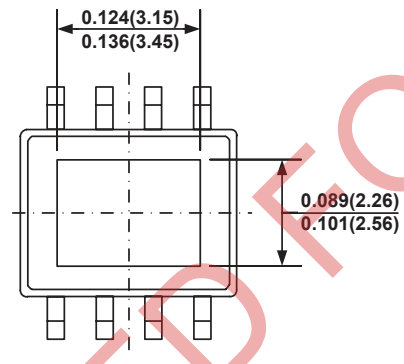
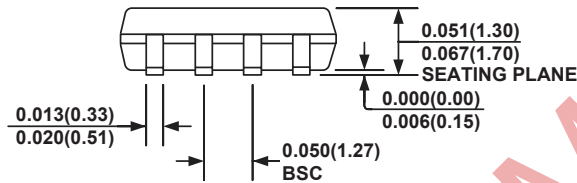
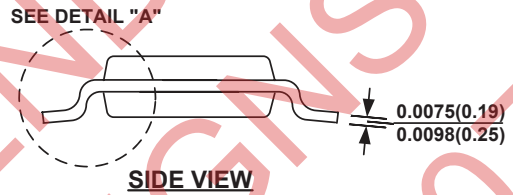
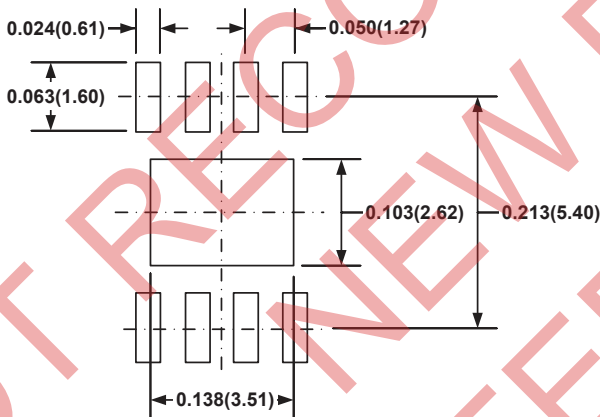
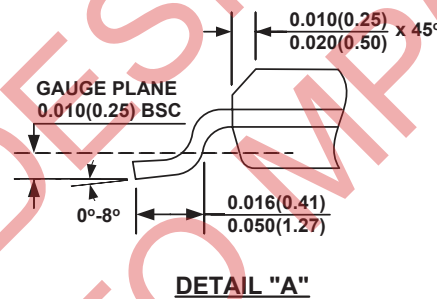
**SOIC8E (EXPOSED PAD)**

**TOP VIEW**

**BOTTOM VIEW**

**FRONT VIEW**

**SIDE VIEW**

**RECOMMENDED LAND PATTERN**

**DETAIL "A"**
**NOTE:**

- 1) CONTROL DIMENSION IS IN INCHES. DIMENSION IN BRACKET IS IN MILLIMETERS.
- 2) PACKAGE LENGTH DOES NOT INCLUDE MOLD FLASH, PROTRUSIONS OR GATE BURRS.
- 3) PACKAGE WIDTH DOES NOT INCLUDE INTERLEAD FLASH OR PROTRUSIONS.
- 4) LEAD COPLANARITY (BOTTOM OF LEADS AFTER FORMING) SHALL BE 0.004" INCHES MAX.
- 5) DRAWING CONFORMS TO JEDEC MS-012, VARIATION BA.
- 6) DRAWING IS NOT TO SCALE.

**NOTICE:** The information in this document is subject to change without notice. Users should warrant and guarantee that third party Intellectual Property rights are not infringed upon when integrating MPS products into any application. MPS will not assume any legal responsibility for any said applications.