

## DESCRIPTION

The MP5083 is a load switch, designed to provide 2A load protection covering 0.5V to 5.5V voltage range. With low  $R_{DS(ON)}$  in tiny package, the MP5083 provides very high efficiency and space-saving solution for notebook, tablet and other portable applications.

The MP5083 is equipped with the very accurate current monitoring function. The gain of the current monitor can be scaled for different applications. With the soft start function, the MP5083 can avoid inrush current during circuit start-up. The MP5083 also provides other features, like power good, output discharge function, and fast short-circuit response time.

This device comes in a tiny 2x2mm QFN12 package.

## FEATURES

- Output Current Monitoring Accuracy as High as 3%
- Wide  $V_{IN}$  Range: from 0.5V to 5.5V
- $<1\mu A$  Shutdown Current
- Integrated 50m $\Omega$  Low  $R_{DS(ON)}$  FET
- Typical 2A Load Current Range
- Push-pull PG Indicator
- Adjustable Start Up Slew Rate
- Output discharge function
- $<200ns$  Short-Circuit Response Protection
- Thermal Protection
- Small 2mmx2mm QFN Package

## APPLICATIONS

- Notebook and Tablet Computers
- Portable Devices
- Solid State Drivers
- Handheld Devices

All MPS parts are lead-free and adhere to the RoHS directive. For MPS green status, please visit MPS website under Quality Assurance.

"MPS" and "The Future of Analog IC Technology" are Registered Trademarks of Monolithic Power Systems, Inc.

## TYPICAL APPLICATION

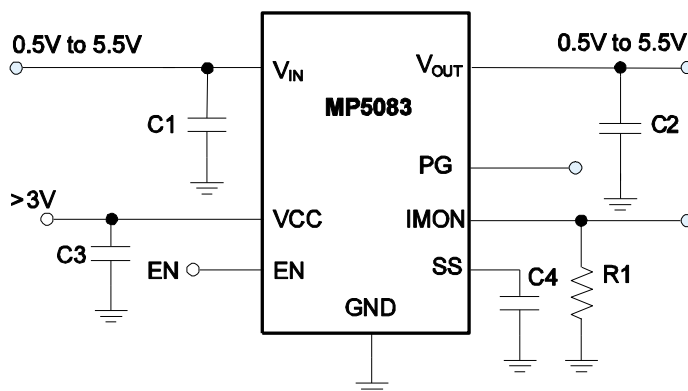

### ORDERING INFORMATION

Part Number*	Package	Top Marking
MP5083GG	QFN-12 (2mmx2mm)	See <i>Blow</i>

\* For Tape & Reel, add suffix -Z (e.g. MP5083GG-Z);

### TOP MARKING

\_\_\_\_\_  
**BFY**  
**LLL**

BF: product code of MP5083GG;  
 Y: year code;  
 LLL: lot number;

### PACKAGE REFERENCE

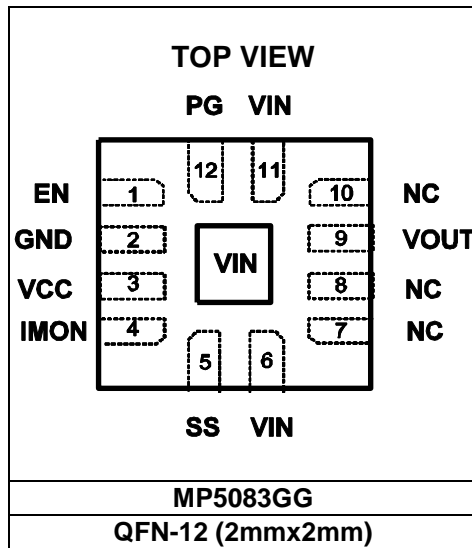

**ABSOLUTE MAXIMUM RATINGS** <sup>(1)</sup>

$V_{IN}$ .....	-0.3V to +6.5V
$V_{CC}$ .....	-0.3V to +6.5V
$V_{OUT}$ .....	-0.3V to +6.5V
EN, SS, IMON .....	-0.3V to $V_{CC}+0.3V$
Junction Temperature .....	150°C
Lead Temperature .....	260°C
Continuous Power Dissipation <sup>(2)</sup>	
QFN12 (2mmx2mm) .....	1.6W

**Recommended Operating Conditions** <sup>(3)</sup>

Supply Voltage $V_{IN}$ .....	0.5V to 5.5V
Supply Voltage $V_{CC}$ .....	3V to 5.5V
Output Voltage $V_{OUT}$ .....	0.5V to 5.5V
Operating Junction Temp .....	-40°C to +125°C

<b>Thermal Resistance</b> <sup>(4)</sup>	$\theta_{JA}$	$\theta_{JC}$	
QFN-12 (2mmx2mm) .....	80	16	°C/W

**Notes:**

- 1) Exceeding these ratings may damage the device.
- 2) The maximum allowable power dissipation is a function of the maximum junction temperature  $T_J$  (MAX), the junction-to-ambient thermal resistance  $\theta_{JA}$ , and the ambient temperature  $T_A$ . The maximum allowable continuous power dissipation at any ambient temperature is calculated by  $P_D$  (MAX) =  $(T_J$  (MAX) -  $T_A$ ) /  $\theta_{JA}$ . Exceeding the maximum allowable power dissipation will cause excessive die temperature, and the regulator will go into thermal shutdown. Internal thermal shutdown circuitry protects the device from permanent damage.
- 3) The device is not guaranteed to function outside of its operating conditions.
- 4) Measured on JESD51-7, 4-layer PCB.

## ELECTRICAL CHARACTERISTICS

$V_{IN} = 3.6V$ ,  $V_{CC} = 3.6V$ ,  $T_A = 25^{\circ}C$ , unless otherwise noted.

Parameters	Symbol	Condition	Min	Typ	Max	Units
<b>Input and Supply Voltage Range</b>						
Input Voltage	$V_{IN}$		0.5		5.5	V
Supply Voltage	$V_{CC}$		3		5.5	V
<b>Supply Current</b>						
Off State Leakage Current	$I_{OFF}$	$V_{IN}=5V$ , $EN=0$			1	$\mu A$
$V_{CC}$ Standby Current	$I_{STBY}$	$V_{CC}=5V$ , $EN=0$		0.1	1	$\mu A$
		$V_{CC}=5V$ , Enable, No load		180	230	
<b>Power FET</b>						
ON Resistance	$R_{DSON}$	$V_{CC}=5.0V$		50		m $\Omega$
		$V_{CC}=3.3V$		60		
<b>Thermal Shutdown and Recovery<sup>(5)</sup></b>						
Shutdown Temperature	$T_{STD}$			150		$^{\circ}C$
Hysteresis	$T_{HYS}$			30		$^{\circ}C$
<b>Under Voltage Protection</b>						
$V_{CC}$ Under Voltage Lockout Threshold	$V_{CC\_UVLO}$	UVLO Rising Threshold		2.6	2.8	V
UVLO Hysteresis	$V_{UVLOHYS}$			200		mV
<b>Soft Start</b>						
SS pull-up current	$I_{SS}$	Fixed slew rate		11		$\mu A$
<b>Enable</b>						
EN Rising Threshold	$V_{ENH}$		1.3	1.5	1.7	V
EN Hysteresis	$V_{EN\_HYS}$			200		mV
<b>IMON</b>						
Current Limit	$I_{OUT}$	$R_{IMON}=23.8k\Omega$ . Ramp $I_{OUT}$ record peak current limit value	1.3	1.4	1.5	A
Current Monitor Accuracy	$V_{IN}=3.6V$	$I_{OUT}=2A$	58.78	60.6	62.42	$\mu A$
		$I_{OUT}=1A$	29.39	30.3	31.21	
		$I_{OUT}=0.6A^{(6)}$	17.45	18.18	18.91	
	$V_{IN}=1V$	$I_{OUT}=2A$	53.17	57.8	62.42	
		$I_{OUT}=1A$	26.58	28.9	31.2	
		$I_{OUT}=0.6A^{(6)}$	15.77	17.34	18.9	
<b>Discharge Resistance</b>						
Discharge Resistance	$R_{DIS}$			200		$\Omega$
<b>PG</b>						
Power Good Rising Threshold	$V_{PG\_R}$	Voltage gap between $V_{OUT}$ and $V_{IN}$	140	280	450	mV
Power Good Hysteresis	$V_{PG\_VHYS}$			60		mV
Power Good Delay	$T_{PG\_D}$			50		$\mu s$
Power Good High	$V_{PG\_H}$	$V_{CC}=3.3V$	3.2			V
Power Good Low	$V_{PG\_L}$	Sink 1mA			0.3	V

**Notes:**

5) Guarantee by design.

6) If load current is smaller than 0.6A, the IMON accuracy will be affected by some internal offset.

## PIN FUNCTIONS

QFN-12 (2mmx2mm) Pin #	Name	Description
1	EN	Enable Input. Pulling this pin below the specified threshold shuts the chip down.
2	GND	Ground.
3	VCC	Supply Voltage to the Control Circuitry.
4	IMON	Output Current Monitor. Provides a voltage proportional to the current flowing through the power device. Place a resistor to ground to set the gain.
5	SS	Soft Start Pin. An external capacitor connected to this pin sets the slew rate of the output voltage soft start period.
6, 11, Exposed pad	VIN	Input Power Supply.
9	VOUT	Output to the Load.
12	PG	Power Good Pin. Push-Pull output.
7,8,10	NC	NC Pin, Suggest connecting them with VOUT to improve the thermal performance and be compatible with MP5087 and MP5077.

## TYPICAL PERFORMANCE CHARACTERISTICS

$V_{IN} = 3.6V$ ,  $V_{CC} = 3.6V$ ,  $R_{IMON} = 13k\Omega$ ,  $T_A = 25^\circ C$ , unless otherwise noted.

### Quiescent Current

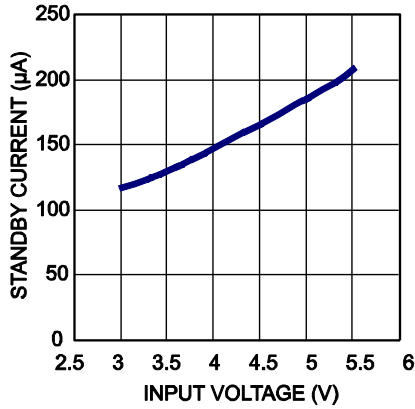

### Disabled Supply Current vs. Input Voltage

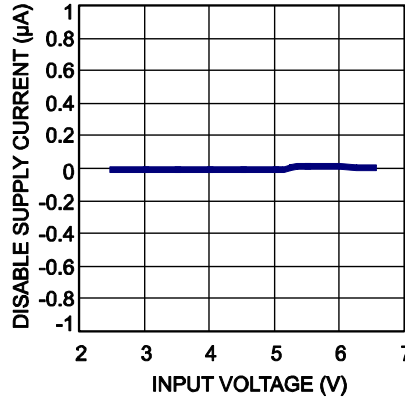

### $V_{IN}$ UVLO vs. Temperature

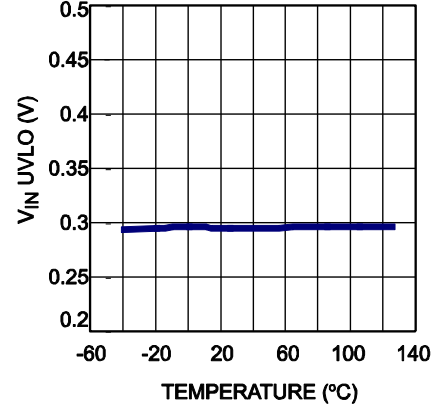

### EN Rising Threshold vs. Temperature

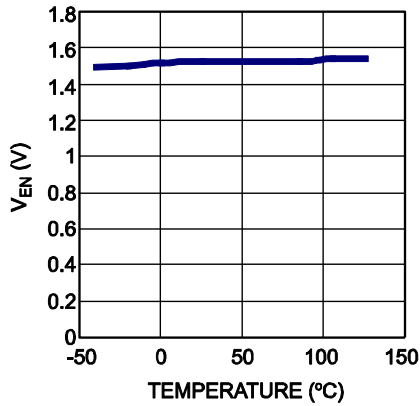

### $R_{DS\_ON}$ vs. $V_{CC}$

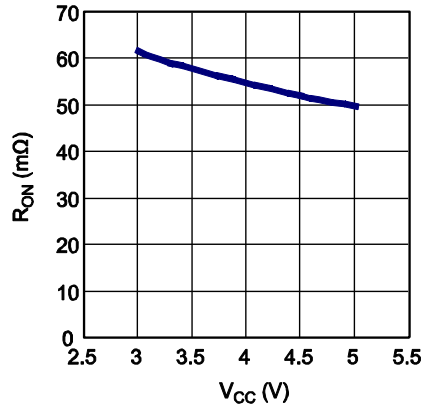

### $R_{DS\_ON}$ vs. Temperature

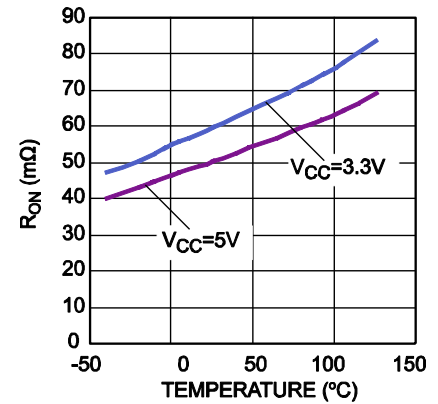

### The Maximum Current Limit vs. $V_{IN}$

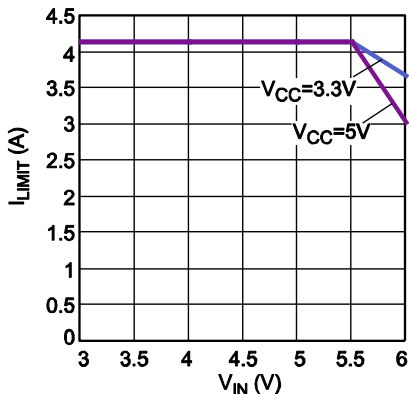

### Current Limit vs. $R_{LIMIT}$

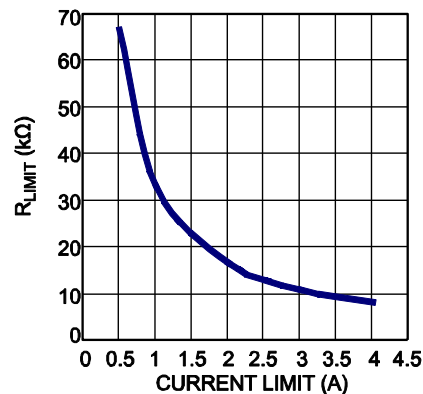

### IMON Accuracy vs. $I_{OUT}$

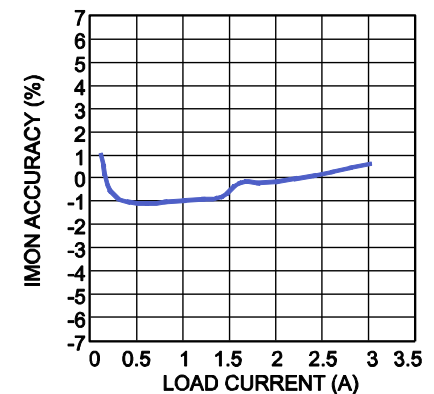

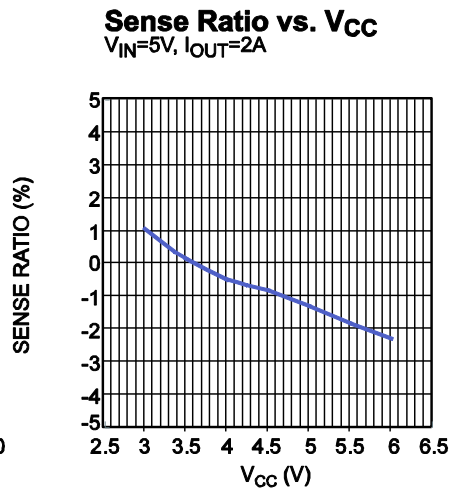
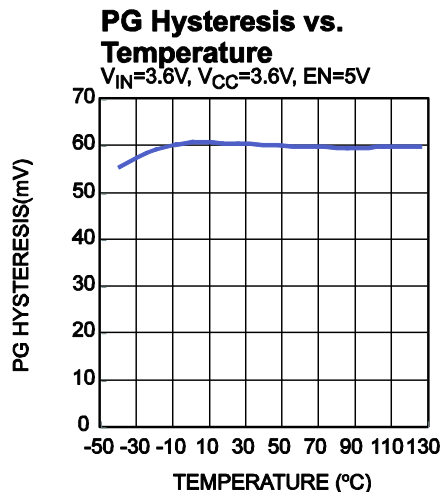
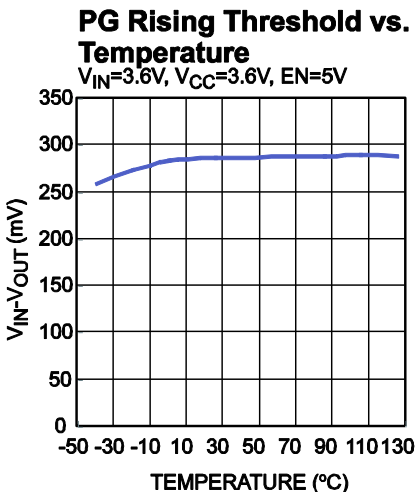
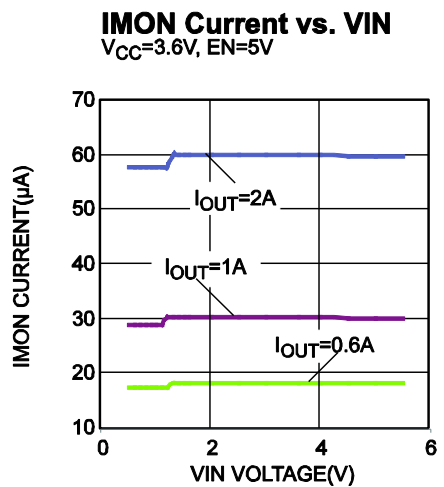
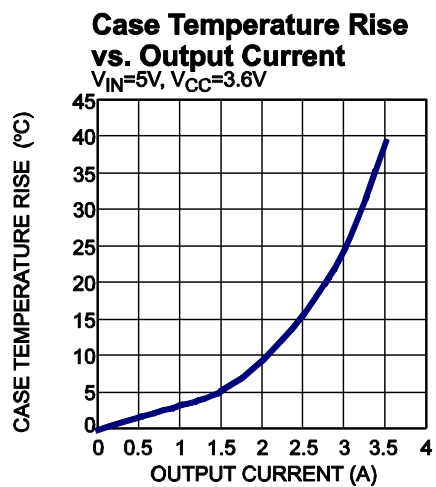
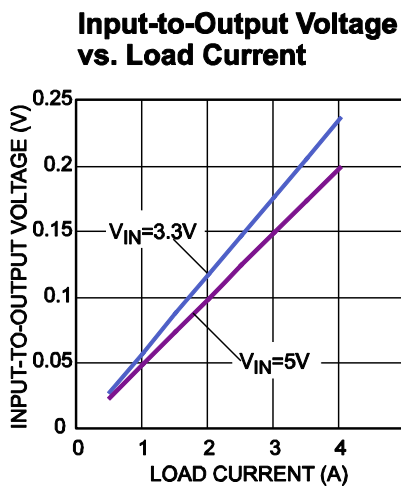
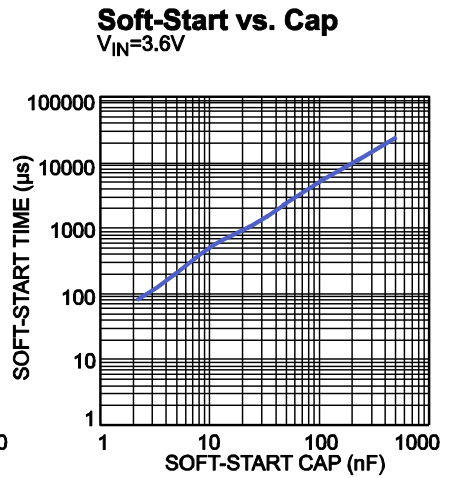
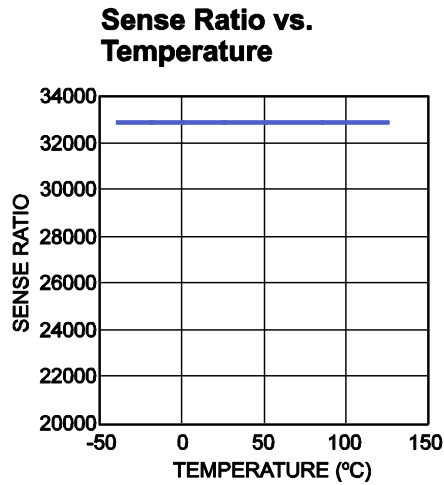
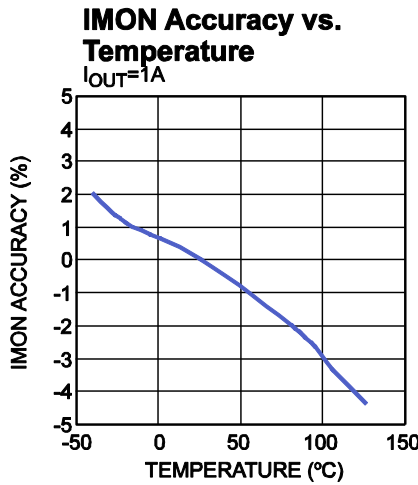
**TYPICAL PERFORMANCE CHARACTERISTICS** *(continued)*
 $V_{IN} = 3.6V$ ,  $V_{CC} = 3.6V$ ,  $R_{IMON} = 13k\Omega$ ,  $T_A = 25^\circ C$ , unless otherwise noted.

**TYPICAL PERFORMANCE CHARACTERISTICS** *(continued)*
 $V_{IN} = 3.6V$ ,  $V_{CC} = 3.6V$ ,  $EN=4V$ ,  $R_{IMON} = 13k\Omega$ ,  $T_A = 25^\circ C$ , unless otherwise noted.

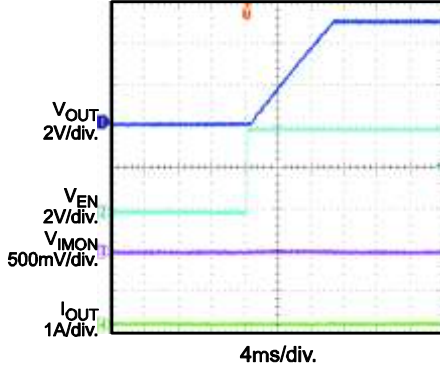
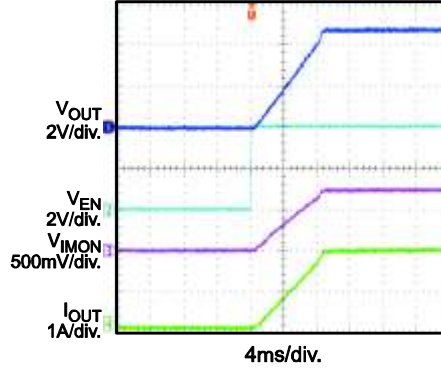
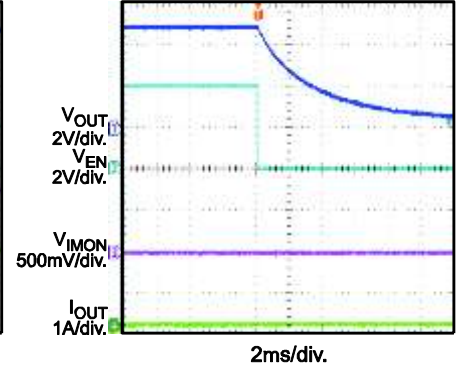
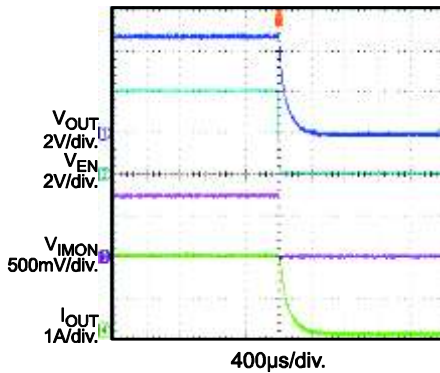
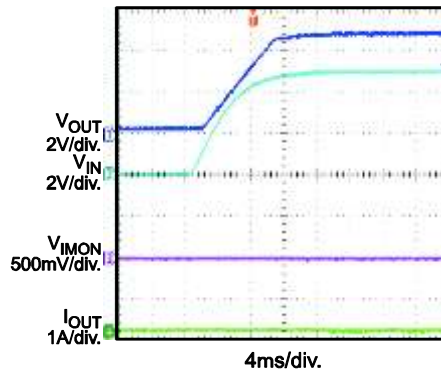
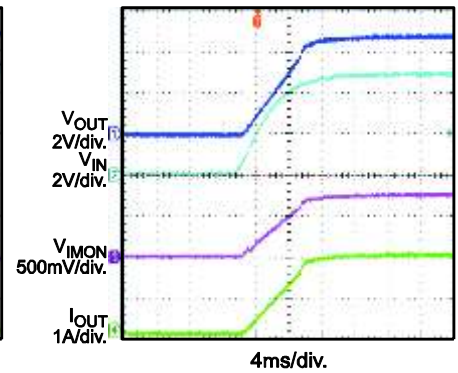
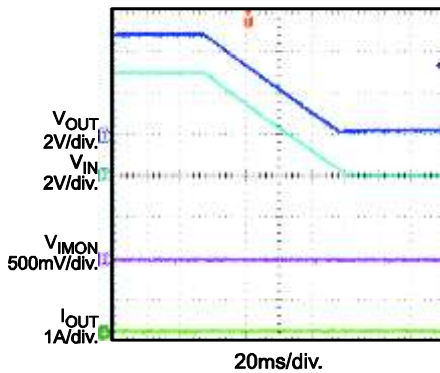
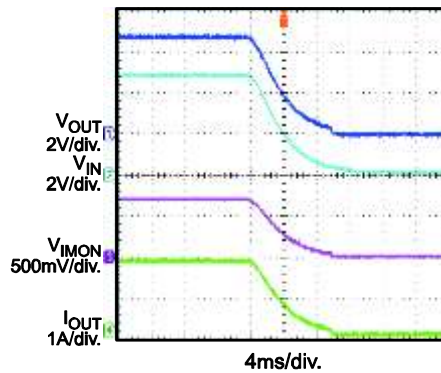
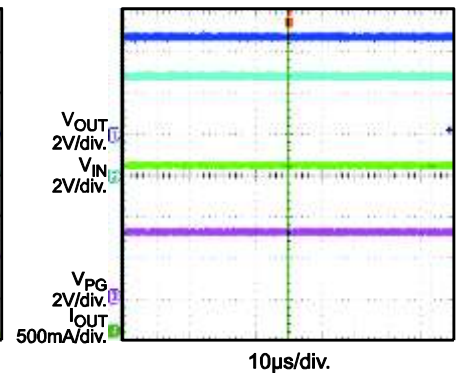
**Enable Startup**
 $V_{IN} = 5V$ ,  $V_{CC} = 3.6V$ , No Load

**Enable Startup**
 $V_{IN} = 5V$ ,  $V_{CC} = 3.6V$ , 2A Load

**Enable Shutdown**
 $V_{IN} = 5V$ ,  $V_{CC} = 3.6V$ , No Load

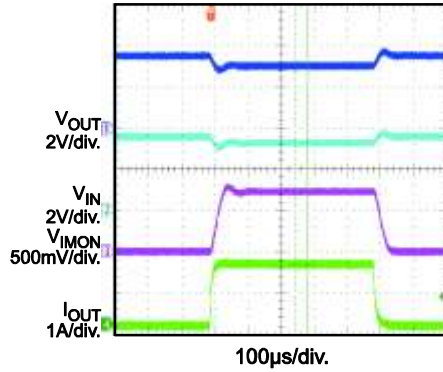
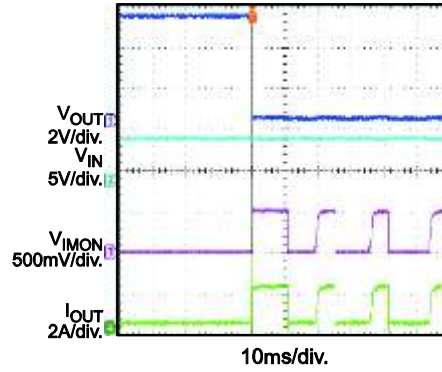
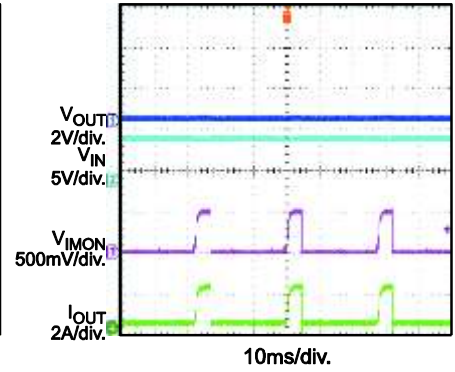
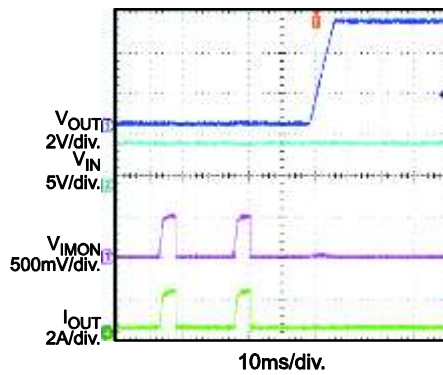
**Enable Shutdown**
 $V_{IN} = 5V$ ,  $V_{CC} = 3.6V$ , 2A Load

**Power Up**
 $V_{IN} = 5V$ ,  $V_{CC} = 3.6V$ ,  $I_{OUT} = 0A$ 

**Power Up**
 $V_{IN} = 5V$ ,  $V_{CC} = 3.6V$ ,  $I_{OUT} = 2A$ 

**Power Down**
 $V_{IN} = 5V$ ,  $V_{CC} = 3.6V$ ,  $I_{OUT} = 0A$ 

**Power Down**
 $V_{IN} = 5V$ ,  $V_{CC} = 3.6V$ ,  $I_{OUT} = 2A$ 

**Steady State**
 $V_{IN} = 5V$ ,  $V_{CC} = 3.6V$ ,  $I_{OUT} = 2A$ 



**TYPICAL PERFORMANCE CHARACTERISTICS** *(continued)*
 $V_{IN} = 3.6V$ ,  $V_{CC} = 3.6V$ ,  $EN=4V$ ,  $R_{IMON} = 13k\Omega$ ,  $T_A = 25^\circ C$ , unless otherwise noted.

**Load Transient Response**
 $V_{IN} = 3.6V$ ,  $V_{CC} = 3.6V$ ,  $I_{OUT} = 0A-2A$ 

**SCP Enter**
 $V_{IN} = 5V$ ,  $V_{CC} = 3.6V$ 

**SCP Steady State**
 $V_{IN} = 5V$ ,  $V_{CC} = 3.6V$ 

**SCP Recovery**
 $V_{IN} = 5V$ ,  $V_{CC} = 3.6V$ 

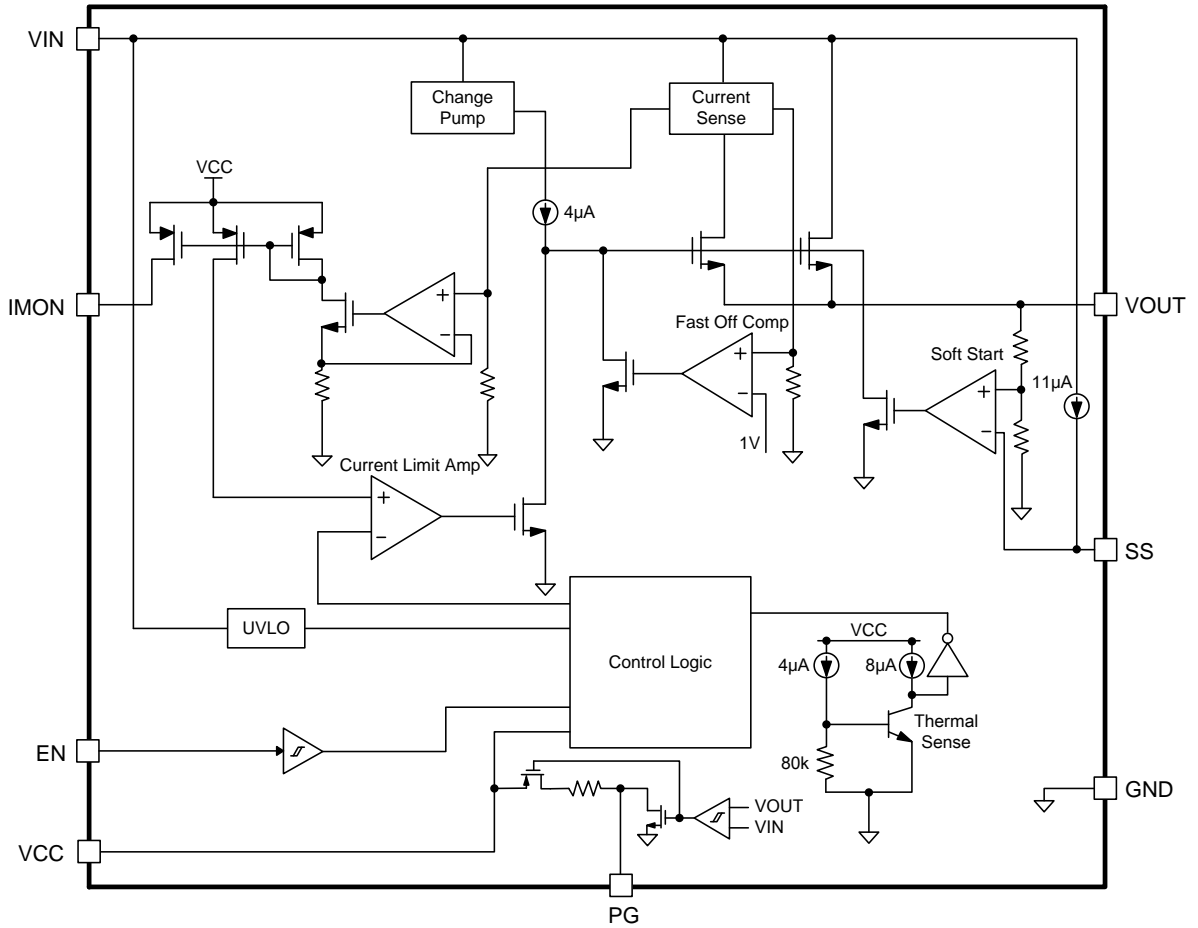

Figure 1: Functional Block Diagram

## OPERATION

The MP5083 is designed to limit the in-rush current to the load thereby limiting the backplane's voltage drop and the slew rate of the voltage to the load. It provides an integrated solution to monitor the input voltage, output voltage and output current to eliminate the need for an external current power MOSFET, and current sense device.

### Enable

When input voltage is greater than the under-voltage lockout threshold (UVLO), typically 0.5V, MP5083 can be enabled by pulling EN pin to higher than 1.5V. Pulling down to ground or floating will disable MP5083.

### Current Limit

The MP5083 provides a constant current limit that can be programmed by an external resistor. Once the device reaches its current limit threshold, the internal circuit regulates the gate voltage to hold the current in the power FET constant. The typical response time is about 20 $\mu$ s and the output current may have a small overshoot during this time period.

The pre-set current limit value can be calculated by below equation:

$$I_{LIMIT} = (1 \div R_{IMON}) \times S \quad (1)$$

S is the current sense ratio of MP5083, and this value is typically 33000 in  $V_{IN}=V_{CC}=3.6V$ . The S is almost a constant value when  $V_{in}$  is changing from 1.2V to 5.5V, and when  $V_{in}$  is smaller than 1.2V, a step change will come to S value, the value will change from 33000 to about 28000. Meanwhile, when  $V_{cc}$  is changing, there is also a little shift on S value, for more information, please refer the curves in typical performance characteristics.

If the current limit block starts to regulate the output current, the power loss on power MOSFET will cause the IC temperature rise. If the junction temperature rose to high enough, it will trigger thermal shutdown. After thermal shutdown happened, it will disable the output until the over temperature fault remove. The over temperature threshold is 150°C and hysteresis is 30°C.

### Power-Good Function

The PG pin is the push pull of a MOSFET that can be pulled high to  $V_{CC}$ . After the voltage gap between  $V_{IN}$  and  $V_{OUT}$  is smaller than 280mV, the PG pin is pulled high after a 50 $\mu$ s delay. When the voltage gap is higher than 340mV, the PG pin will be pulled low.

### Short-Circuit Protection

If the load current increases rapidly due to a short circuit, the current may exceed the current limit threshold by a lot before the control loop can respond. If the current reaches an internal secondary current limit level (about 7A), a fast turn-off circuit activates to turn off the power FET. This limits the peak current through the switch to limit the input voltage drop. The total short circuit response time is about 200ns. If fast off works, it will keep off the power FET for 80 $\mu$ s. After that time period, it will re-turn on power FET, if the part is still in short-circuit condition. MP5083 will reduce the current limit, and hold it until the part is so hot and thermal shutdown. After the short-circuit condition removed, the current limit will recover to the pre-set value automatically.

### Output Discharge

MP5083 has output discharge function. This function can discharge the  $V_o$  by internal pull down resistance when IC EN disabled or  $V_{CC}$  shutdown and the load is very light.

### Soft-Start

A capacitor connected to the SS pin determines the soft-start time. There is an internal 11 $\mu$ A constant current source charge SS cap and ramps up the voltage on the SS pin. The output voltage rises at 5 times the slew rate to the SS voltage.

The soft-start time can be calculated by below equation:

$$T_{SS}(\text{ms}) = \frac{1}{5} \times \frac{V_{OUT}(\text{V}) \cdot C_{SS}(\text{nF})}{I_{SS}(\text{uA})} \quad (2)$$

$T_{SS}$  is the soft-start time,  $I_{SS}$  is internal 11 $\mu$ A constant current,  $C_{SS}$  is external soft-start cap.

The suggestion minimum SS cap should be bigger than 4.7nF. If the SS pin is floated or SS cap is too small, the  $V_{OUT}$  rising time will be just limited by power MOS charge time.

## APPLICATION INFORMATION

### IMON Resistor Selection

The current limit value can be set by IMON resistor. The current limit can be gotten by equation (1).

The current limit threshold is suggested to 10% ~ 20% higher than maximum load current. For example, if the system's full load is 2A, set the current limit to 2.2A.

### IMON Capacitor Selection

The internal advanced auto-zero comparator bring a high accuracy of current monitor. The auto-zero will also cause some little jitter on IMON pin. To get a more stable IMON, a small ceramic capacitor can be mounted between IMON and ground. Suggested place an IMON capacitor less than 1nF.

### Soft Start Capacitor Selection

There is an internal 11 $\mu$ A constant current source charge SS cap and ramps up the voltage on the SS pin. The output voltage rises follow the 5 times the slew rate of SS voltage.

If the inrush on output current reached the current limit during start up (like with large output cap or very large load), MP5083 will limit the output current and the same time, SS time will be increased (Fig 2 and Fig 3).

### Component Selection

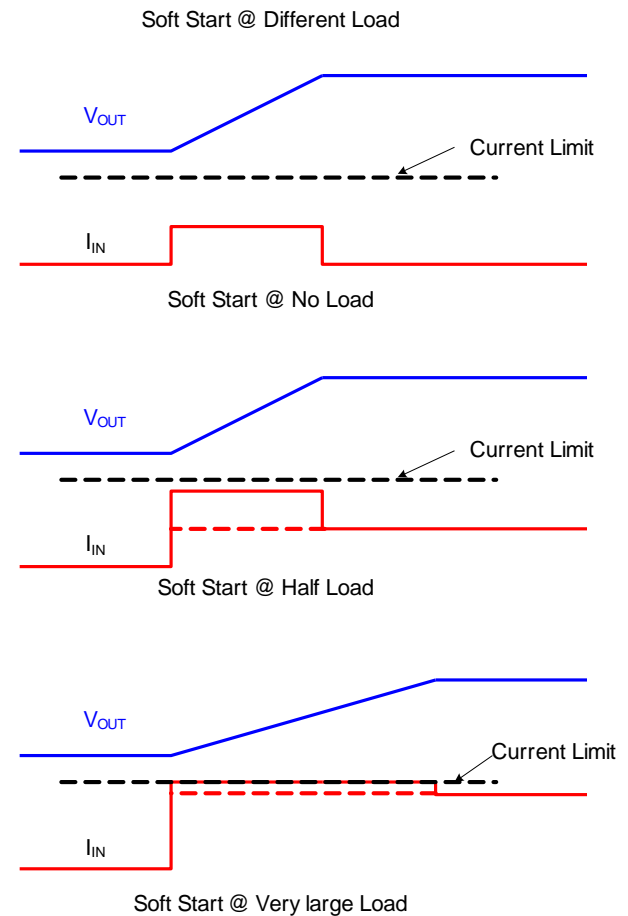

**Figure 2: Soft Start Periods at different load**

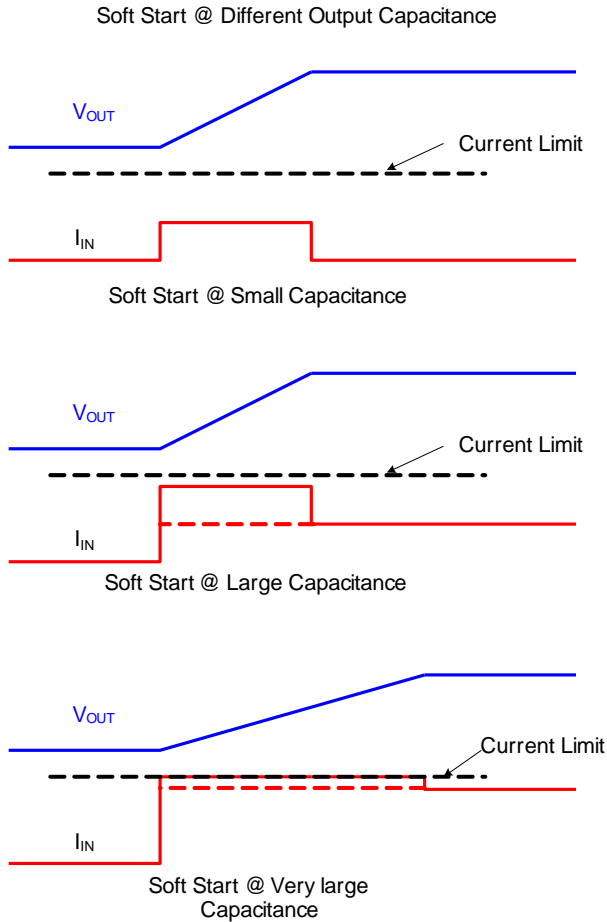

**Figure 3: Soft Start Periods at different output capacitance**

**Design Example**

Some design example and are provided below. See Table 1 and Figure 4.

**Table 1**

V <sub>IN</sub> (V)	Max Load Range (A)	R <sub>limit</sub> (kΩ)	SS cap (nF)	SS time (ms)
3.6	0.5	47	22	1
3.6	1	27.4	47	2.4
3.6	2	15	100	5.4

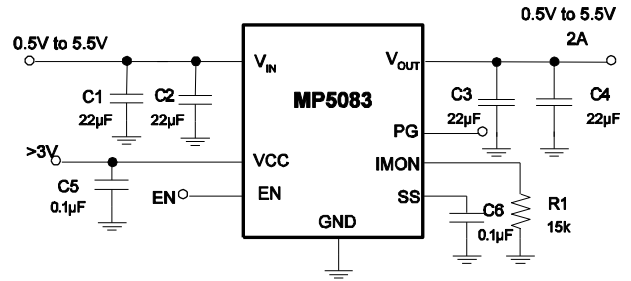

**Figure 4: Typical Application Schematic**

**Layout Guide**

PCB layout is very important to achieve stable operation. Please follow these guidelines and take below figure for reference. Place R<sub>IMON</sub> close to IMON pin, input cap close to V<sub>CC</sub> pin. Put enough vias around IC to achieve better thermal performance.

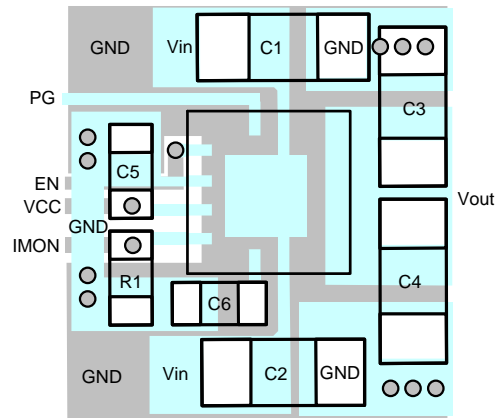

**Figure 5: Recommended Layout**

**PACKAGE INFORMATION**

**QFN-12 (2mmx2mm)**

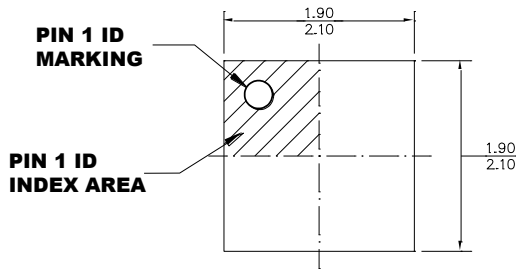

**TOP VIEW**

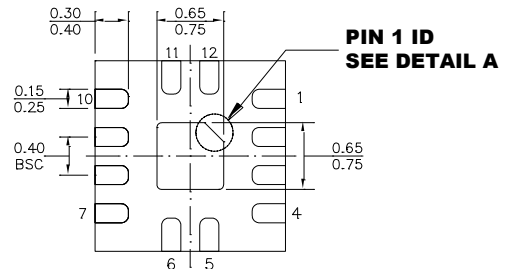

**BOTTOM VIEW**

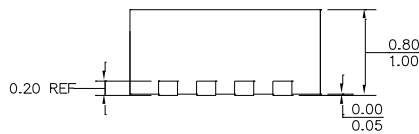

**SIDE VIEW**

**PIN 1 ID OPTION A  
0.20x45° TYP.**



**PIN 1 ID OPTION B  
R0.20 TYP.**

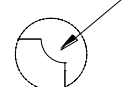

**DETAIL A**

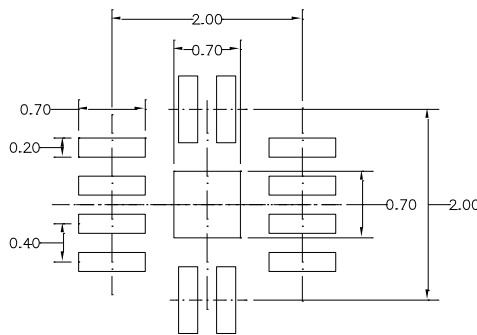

**RECOMMENDED LAND PATTERN**

**NOTE:**

- 1) ALL DIMENSIONS ARE IN MILLIMETERS.
- 2) EXPOSED PADDLE SIZE DOES NOT INCLUDE MOLD FLASH.
- 3) LEAD COPLANARITY SHALL BE 0.10 MILLIMETERS MAX.
- 4) JEDEC REFERENCE IS MO-229.
- 5) DRAWING IS NOT TO SCALE.

**NOTICE:** The information in this document is subject to change without notice. Please contact MPS for current specifications. Users should warrant and guarantee that third party Intellectual Property rights are not infringed upon when integrating MPS products into any application. MPS will not assume any legal responsibility for any said applications.