



The Future of Analog IC Technology®

# MP5010B

## 3V-18V, 1A-5A Programmable-Current-Limit Switch with Over-Voltage Clamp

### DESCRIPTION

The MP5010B is a protection device designed to protect circuitry on the output (source) from transients on the input ( $V_{CC}$ ). It also protects the input from undesired shorts and transients coming from the source.

A small capacitor on the dv/dt pin controls the slew rate that limit the inrush current at the source. For instance, a 1nF capacitor results in a source ramp-up time of 3ms.

The maximum load at the source is current limited using a sense FET topology. An external resistor between the I-Limit pin and the Source pins controls the magnitude of the current limit.

An internal charge pump drives the gate of the power device, allowing the DMOS power FET to have a very low ON-resistance of just 40mΩ.

The MP5010B also protects the source from the input being too low or too high. Under-voltage lockout ensures that the input remains above the minimum operating threshold before the power device turns on. If the input rises above the high output threshold, the MP5010B limits the source voltage.

### FEATURES

- Wide 3V-to-18V Operating Input Range
- 5.7V Output Over-Voltage Clamp
- Integrated 40mΩ Power FET
- Enable/Fault Pin
- Adjustable Output Voltage Slew Rate
- Adjustable Current Limit
- Thermal Protection

### APPLICATIONS

- Hot-Swappable Devices
- Wireless Modem Data Cards
- PC Cards
- Laptops

All MPS parts are lead-free and adhere to the RoHS directive. For MPS green status, please visit MPS website under Products, Quality Assurance page.

"MPS" and "The Future of Analog IC Technology" are Registered Trademarks of Monolithic Power Systems, Inc.

### TYPICAL APPLICATION

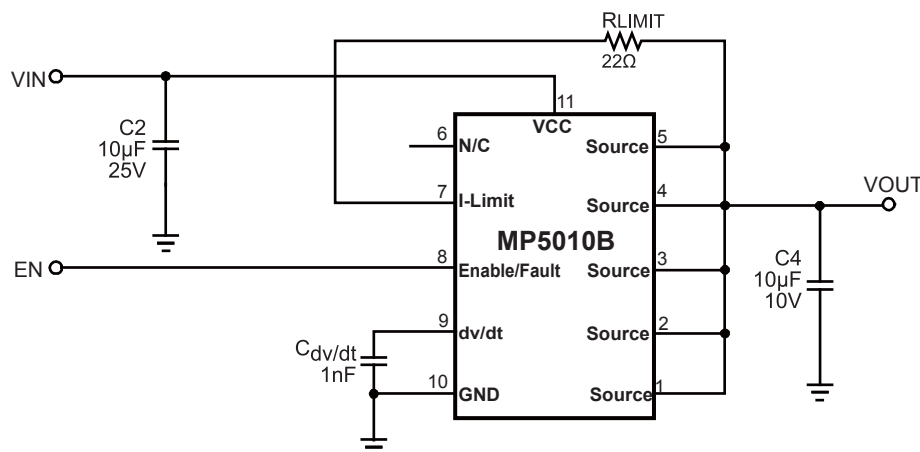

### ORDERING INFORMATION

Part Number*	Package	Top Marking
MP5010BDQ	QFN10 (3mm×3mm)	AFN

\* For Tape & Reel, add suffix –Z (e.g. MP5010BDQ–Z).

For RoHS compliant packaging, add suffix –LF (e.g. MP5010BDQ-LF-Z).

### PACKAGE REFERENCE

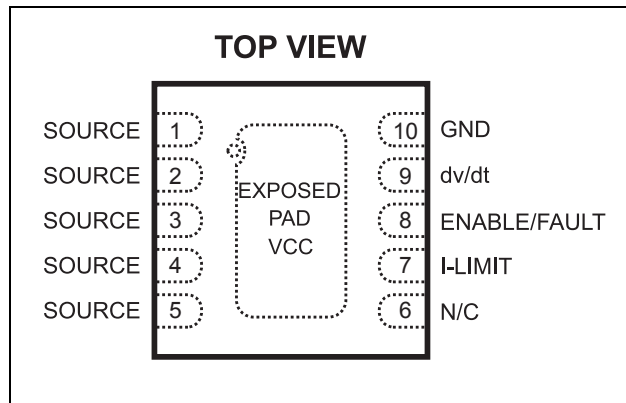

#### ABSOLUTE MAXIMUM RATINGS <sup>(1)</sup>

$V_{CC}$ , SOURCE, I-LIMIT ..... –0.3V to 22V  
 dv/dt, ENABLE/FAULT ..... –0.3V to 6V  
 Storage Temperature ..... –65°C to +155°C  
 Junction Temperature ..... +150°C  
 Lead Temperature ..... +260°C  
 Continuous Power Dissipation ( $T_A=+25^\circ\text{C}$ ) <sup>(2)</sup>  
 ..... 2.5W

#### Recommended Operating Conditions <sup>(3)</sup>

Input Voltage Operating Range ..... 3V to 18V  
 Operating Junction Temp. ( $T_J$ ) ..... –40°C to +125°C

**Thermal Resistance <sup>(4)</sup>**       $\theta_{JA}$        $\theta_{JC}$   
 QFN10 (3mmx3mm) ..... 50 ..... 12... °C/W

**Notes:**

- Exceeding these ratings may damage the device.
- The maximum allowable power dissipation is a function of the maximum junction temperature  $T_{J(MAX)}$ , the junction-to-ambient thermal resistance  $\theta_{JA}$ , and the ambient temperature  $T_A$ . The maximum allowable power dissipation at any ambient temperature is calculated using:  $P_D(MAX) = (T_{J(MAX)} - T_A) / \theta_{JA}$ . Exceeding the maximum allowable power dissipation will cause excessive die temperature, and the regulator will go into thermal shutdown. Internal thermal shutdown circuitry protects the device from permanent damage. Reduce 0.2 Watts for every 10°C ambient temperature increasing
- The device is not guaranteed to function outside of its operating conditions.
- Measured on JESD51-7 4-layer board.

**ELECTRICAL CHARACTERISTICS**
 **$V_{CC} = 5V$ ,  $R_{LIMIT}=22\Omega$ , Capacitive Load=  $10\mu F$ ,  $T_A=25^\circ C$ , unless otherwise noted.**

Parameters	Symbol	Condition	Min	Typ	Max	Units
<b>Power FET</b>						
Delay Time	$\tau_{DLY}$	Enabling of chip to $I_D=40mA$ with a $5\Omega$ resistive load		44		$\mu s$
ON Resistance	$R_{DSon}$	$T_J=25^\circ C$		40	55	m $\Omega$
		$T_J=85^\circ C^{(5)}$		52		
OFF-State Output Voltage	$V_{OFF}$	$V_{CC}=18V$ , $V_{EN}=0V$ , $R_L=500\Omega$			120	mV
Continuous Current	$I_D$	$0.5\text{ in}^2$ pad, $T_A=25^\circ C$		4.2		A
		minimum copper, $T_A=80^\circ C$		2.3		
<b>Thermal Latch</b>						
Shutdown Temperature <sup>(5)</sup>	$T_{SD}$			175		$^\circ C$
<b>Under/Over-Voltage Protection</b>						
Output Clamp Voltage	$V_{CLAMP}$	Over-Voltage Protection $V_{CC}=8V$	5.5	5.7	5.9	V
Under-Voltage Lockout	$V_{UVLO}$	Rising Edge	2.65	2.8	2.9	V
Under-Voltage Lockout (UVLO) Hysteresis	$V_{HYST}$			0.15		V
<b>Current Limit<sup>(6)</sup> (For Direct Current-Sense, refer to typical application in Figure 5)</b>						
Hold Current	$I_{LIM-SS}$	$0\Omega$ Short Resistance, $R_{LIM}=22\Omega$	2.2	2.8	3.4	A
Trip Current	$I_{LIM-OL}$	$R_{LIM}=22\Omega$		4.3		A
<b>Current Limit<sup>(6)</sup> (For Kelvin Sense, refer to typical application in Figure 4)</b>						
Hold Current	$I_{LIM-SS}$	$0\Omega$ Short Resistance, $R_{LIM}=22\Omega$	0.77	1.10	1.43	A
Trip Current	$I_{LIM-OL}$	$R_{LIM}=22\Omega$		2.18		A
<b>dv/dt Circuit</b>						
Rise Time <sup>(7)</sup>	$\tau_r$	$C_{dv/dt}=1nF$	2	3	4	ms
<b>Enable/Fault</b>						
Low-Level Input Voltage	$V_{IL}$	Output Disabled			0.5	V
Intermediate-Level Input Voltage	$V_{I(INT)}$	Thermal Fault, Output Disabled	0.82	1.4	1.95	V
High-Level Input Voltage	$V_{IH}$	Output Enabled	2.5			V
HIGH-State Maximum Voltage	$V_{I(MAX)}$			4.95		V
Pull-Up Current (Source)	$I_{IL}$	$V_{ENABLE}=0V$	15	25	35	$\mu A$
Maximum Fanout for Fault Signal		Maximum number of chips for simultaneous shutdown			3	Units
Maximum Voltage on EN <sup>(8)</sup>	$V_{MAX}$				$V_{CC}$	V

**ELECTRICAL CHARACTERISTICS (continued)**
 **$V_{CC} = 5V$ ,  $R_{LIMIT} = 22\Omega$ , Capacitive Load =  $10\mu F$ ,  $T_A = 25^\circ C$ , unless otherwise noted.**

Parameters	Symbol	Condition	Min	Typ	Max	Units
<b>Total Device</b>						
Bias Current	$I_{BIAS}$	Device Operational		860	950	$\mu A$
		Thermal Shutdown		580	650	
Minimum Operating Voltage for UVLO	$V_{MIN}$	Enable < 0.5V			2.5	V

**Notes:**

- 5) Guaranteed by design.
- 6) Guaranteed by Characterization Test.
- 7) Measured from 10% to 90%.
- 8) Maximum Input Voltage on Enable pin to be  $\leq 6V$  if  $V_{CC} \geq 6V$ . Maximum Input Voltage on Enable pin to be  $V_{CC}$  if  $V_{CC} \leq 6V$ .

## TYPICAL PERFORMANCE CHARACTERISTICS

$V_{IN} = 5V$ ,  $V_{EN}=5V$ ,  $R_{LIMIT}=22\Omega$ ,  $C_{OUT}=10\mu F$ ,  $C_{dv/dt} = 1nF$ ,  $T_A=25^\circ C$ , unless otherwise noted.

**Trip Current & Hold Current vs.  $R_{LIMIT}$**   
Direct Connection,  $V_{IN}=5V$

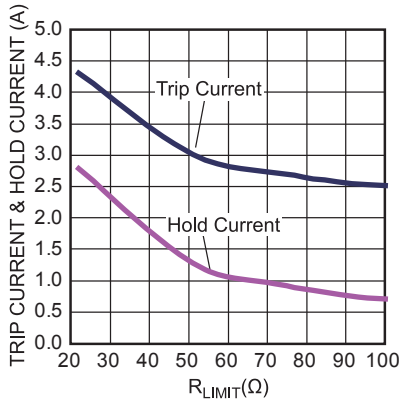

**Trip Current & Hold Current vs.  $R_{LIMIT}$**   
Kelvin Connection,  $V_{IN}=5V$

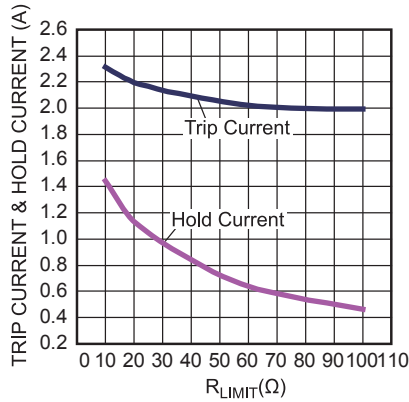

**Supply Current, Output Enabled vs. Input Voltage**  
No Load

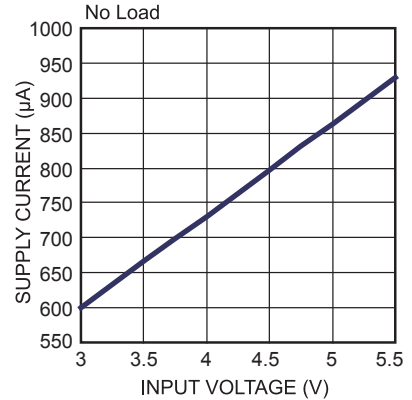

**Supply Current, Output Disabled vs. Input Voltage**  
 $V_{EN}=0V$

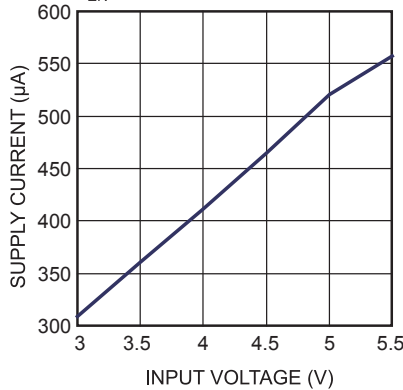

**$R_{DS\_ON}$  vs. Input Voltage**  
 $I_{OUT}=0.5A$

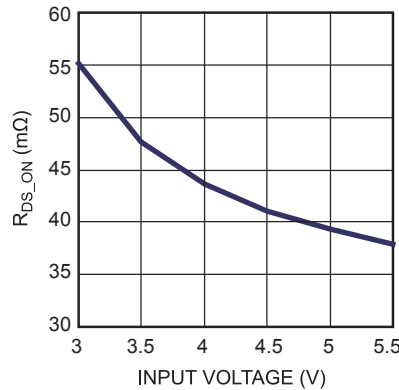

**Input to Output Voltage vs. Load Current**

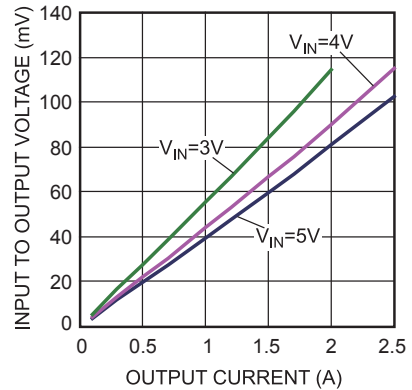

**Hold Current vs. Input Voltage**

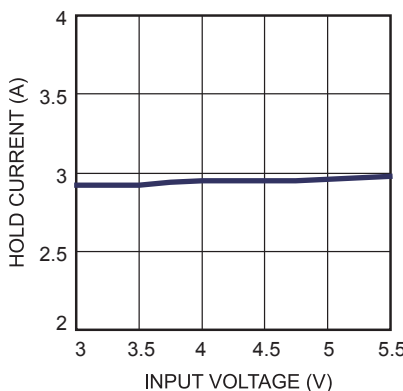

**Trip Current vs. Input Voltage**

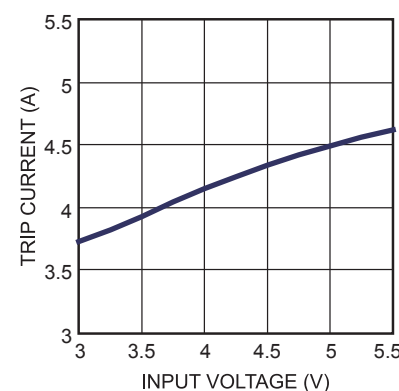

**Current Limit Response vs. Peak Current**

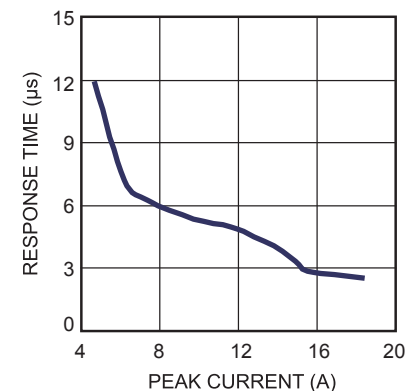

**TYPICAL PERFORMANCE CHARACTERISTICS (continued)**
 $V_{IN} = 5V$ ,  $V_{EN}=5V$ ,  $R_{LIMIT}=22\Omega$ ,  $C_{OUT}=10\mu F$ ,  $C_{dv/dt} = 1nF$ ,  $T_A=25^\circ C$ , unless otherwise noted.

**Startup through Input Voltage**

En Float, no load

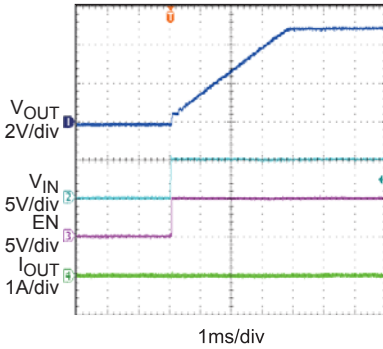

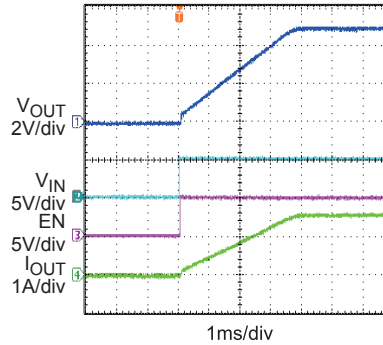
**Startup through Input Voltage**

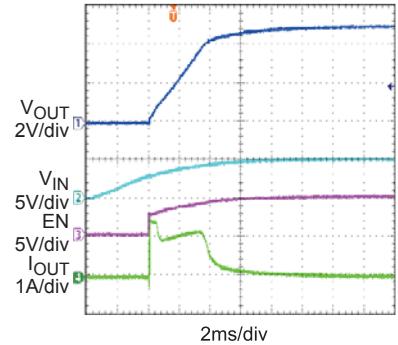
 En Float,  $R_{LOAD} = 3.3\Omega$ 

**Startup through Input Voltage**

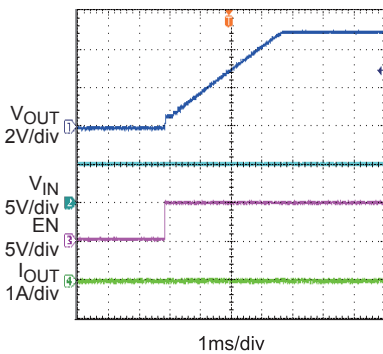
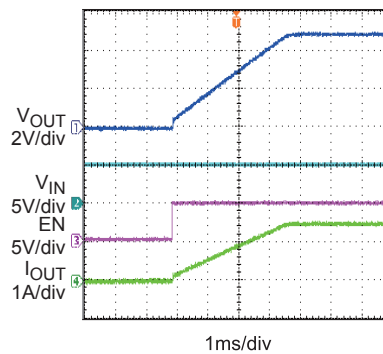
 En Float, No Load,  $C_{OUT} = 2200\mu F$ 

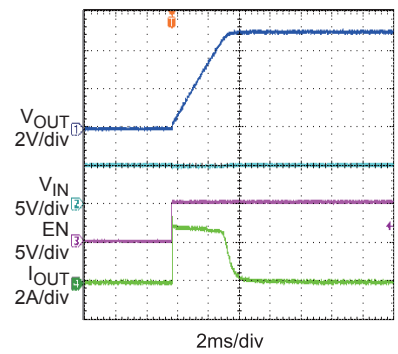
**Startup through Enable**

No Load

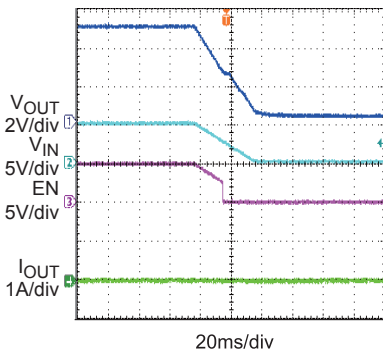
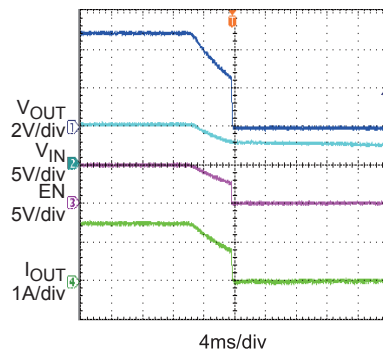

**Startup through Enable**
 $R_{LOAD} = 3.3\Omega$ 

**Startup through Enable**

 No Load,  $C_{OUT} = 2200\mu F$ 

**Shutdown through Input Voltage**

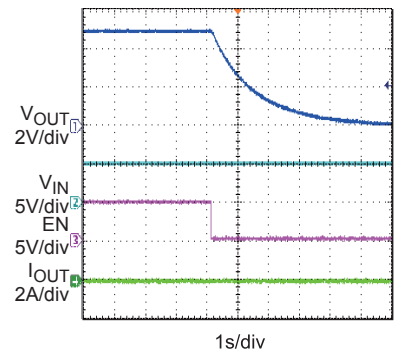
No Load

**Shutdown through Input Voltage**
 $R_{LOAD} = 3.3\Omega$ 

**Shutdown through Enable**

No Load

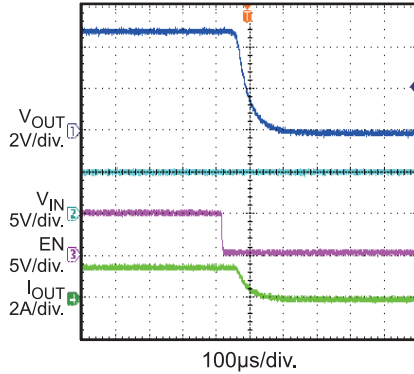
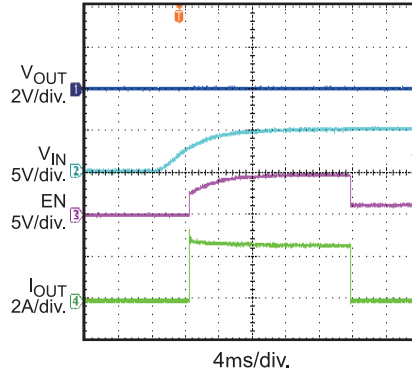
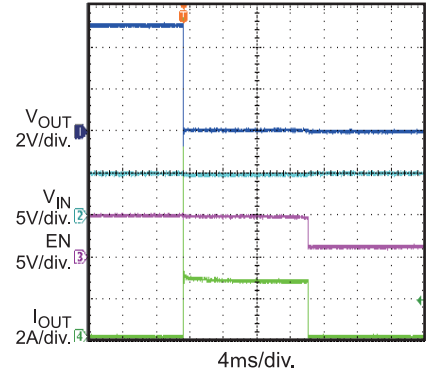
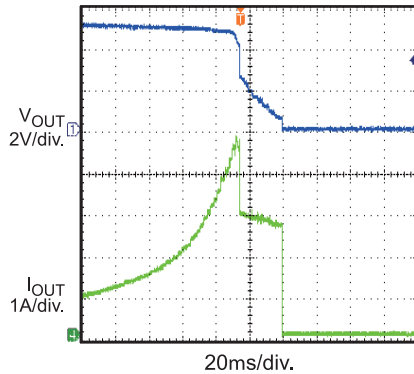
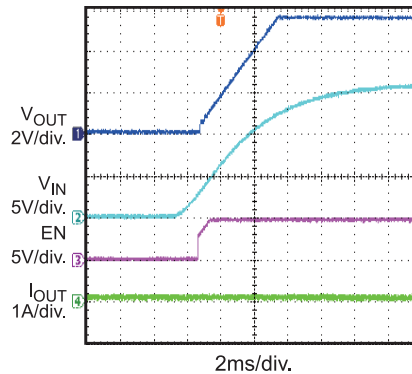

**TYPICAL PERFORMANCE CHARACTERISTICS (continued)**
 $V_{IN} = 5V, V_{EN}=5V, R_{LIMIT}=22\Omega, C_{OUT}=10\mu F, C_{dv/dt} = 1nF, T_A=25^\circ C$ , unless otherwise noted.

**Shutdown Through Enable**  
 $R_{LOAD} = 3.3\Omega$ 

**Short Circuit before Input Voltage Startup, and Thermal Shutdown**

**Short Circuit during Normal Operation, and Thermal Shutdown**

**Current Limit**

**Start Up into OVP, no load EN float**
 $V_{IN} = 16V$ 

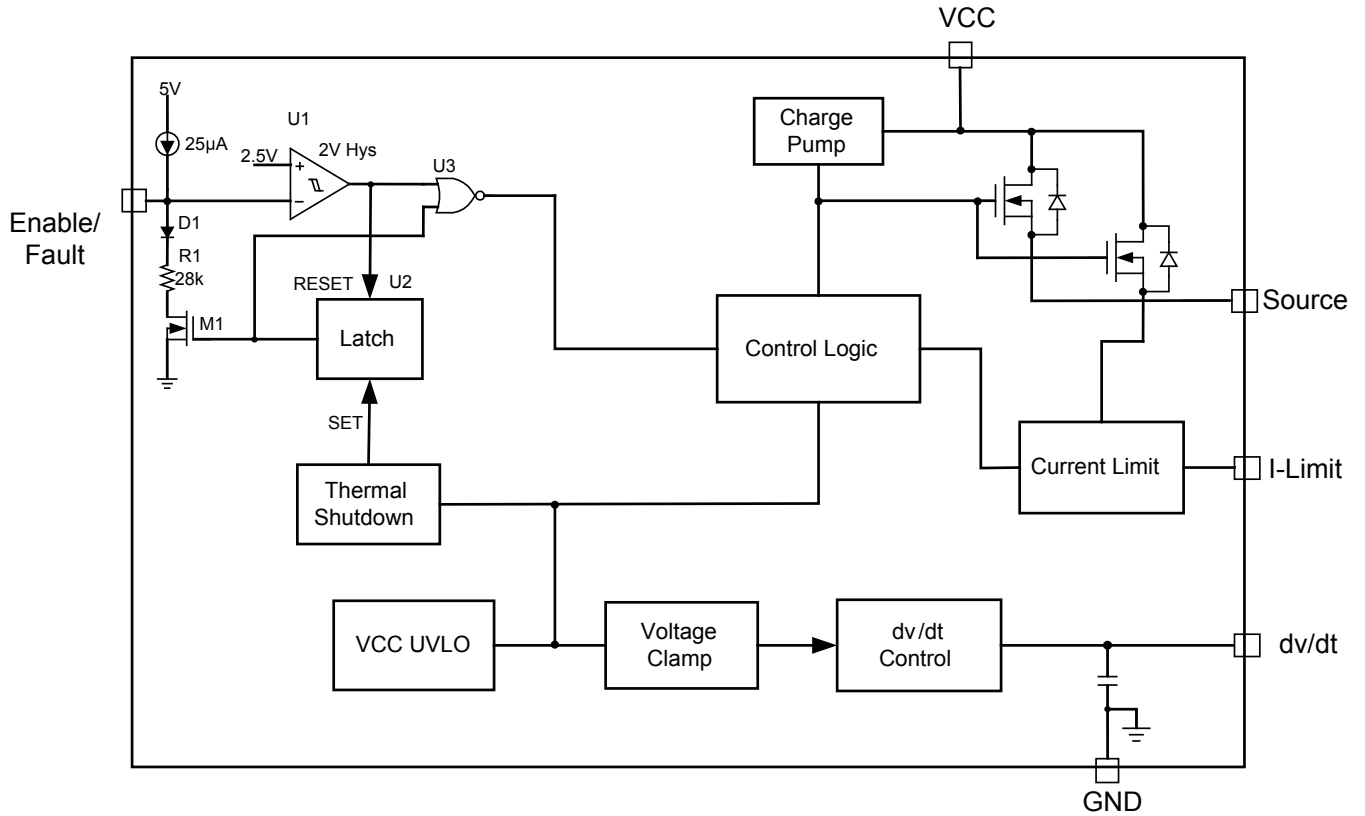
**PIN FUNCTIONS**

Pin #	Name	Description
1-5	SOURCE	Source. Internal power FET source. IC output.
6	N/C	DO NOT CONNECT—leave floating.
7	I-Limit	Current Limit. Using a resistor between this pin and Source to set the overload and short-circuit current-limit levels.
8	Enable/Fault	Enable/Fault. A tri-state, bi-directional interface. Leave floating to enable the output. Pull to ground (using an open drain or open collector device) to disable the output. If a thermal fault occurs, this voltage enters an intermediate state to signal that the device is in thermal shutdown.
9	dv/dt	Slew Rate. The internal dv/dt circuit controls the slew rate of the output voltage at turn-on.
10	GND	Ground. Internal IC reference.
11 Exposed Pad	V <sub>CC</sub>	Input. Positive input voltage.



**BLOCK DIAGRAM**



**Figure 1: Functional Block Diagram**

## OPERATION

The MP5010B limits the inrush current to the load when a circuit card connects to a live backplane power source, thereby limiting the backplane's voltage drop and the  $dV/dt$  of the voltage to the load. It offers an integrated solution to monitor the input voltage, output voltage, output current, and die temperature, eliminating the external current-sense power resistor, power MOSFET, and thermal sensor.

### Under-Voltage Lockout Operation

If the supply (input) is below the UVLO threshold, the output is disabled, and the EN/Fault line is driven low.

When the supply rises above the UVLO threshold, the output is enabled and the EN/Fault is pulled high through a  $25\mu\text{A}$  current source without an external pull-up resistor. The pull-up voltage is limited to 4.95V.

### Output Over-Voltage Protection

If the input voltage exceeds the over-voltage protection (OVP) threshold, the output is clamped at 5.7V (typ).

### Current Limiting

When the chip is active, if load reaches the over-current protection (OCP) threshold (trip current) or a short is present, the part switches to constant-current mode (hold current). The chip shuts down only if the over-current condition eventually triggers thermal protection. However, when the part is powered up by  $V_{CC}$  or EN, the load current should be smaller than the hold current. Otherwise, the part can't be fully turned on.

In a typical application with a current-limiting resistor of  $22\Omega$ , the trip current is 2.18A for Kelvin current sensing and 4.3A for direct current sensing. If the device is in normal operation and passing 2.0A, it will only need to dissipate 160mW with the low ON resistance of  $40\text{m}\Omega$ . For a package dissipation of  $50^\circ\text{C/Watt}$ , the temperature rise is  $+8^\circ\text{C}$ . Given a  $25^\circ\text{C}$  ambient temperature, the typical package temperature is  $33^\circ\text{C}$ .

The MP5010B requires a heat sink during constant-current mode (such as from a short-circuit) to prevent unwanted shutdown: In constant-current mode, the chip must dissipate the power from a 5V drop. Without additional heat dissipation at  $50^\circ\text{C/Watt}$ , the temperature would exceed the thermal threshold ( $+175^\circ\text{C}$ ) and the MP5010B will shutdown to force the temperature to drop below a hysteresis level. Without a heat sink, maintain the current below 600mA at  $+25^\circ\text{C}$  and below 360mA at  $+85^\circ\text{C}$  to prevent thermal shutdown.

### Thermal Protection

If the temperature exceeds the thermal threshold, the MP5010B disables its output and drives the Enable/Fault line to the middle (MID) level (read the following Enable/Fault Pin section for more information). The thermal fault condition is latched, and the part remains OFF until the Enable/Fault line goes low. Cycling the power below the UVLO threshold will also reset the fault flag.

### Fault and Enable Pin

The Enable/Fault pin is a bi-directional, three-level I/O with a weak pull-up current ( $25\mu\text{A}$ , typ.). The three levels are LOW, MID, and HIGH. It functions to enable/disable the part and to relay fault information.

Enable/Fault as an input:

1. LOW and MID disable the part.
2. LOW, in addition to disabling the part, clears the fault flag.
3. HIGH enables the part (if the fault flag is clear).

Enable/Fault as an output:

1. The pull-up current will allow a "wired nor" pull-up to enable the part (if not overridden).
2. An under-voltage condition will cause a LOW on the Enable/Fault pin, and will clear the fault flag.
3. A thermal fault will set a MID on the Enable/Fault pin, and will set the fault flag

The Enable/Fault line must remain above the MID level for the output to turn ON.

The fault flag is an internal flip-flop that can be set or reset under the following conditions:

1. Thermal Shutdown: set fault flag
2. Under-Voltage: reset fault flag
3. LOW on Enable/Fault pin: reset fault flag
4. MID on Enable/Fault pin: no effect

Given a fault, the Enable/Fault pin is driven to MID.

There are 4 types of faults, and each fault has a direct and indirect effect on the Enable/Fault pin and the internal fault flag. In a typical application there are one or more of the MP5010B chips in a system. The Enable/Fault lines are typically be connected together.

**Table 1—Fault Function Influence in Application**

Fault description	Internal action	Effect on Fault Pin	Effect on Flag	Effect on secondary Part
Short/Over Current	Limit current	none	none	none
Under Voltage	Output turns OFF	Internally drives Enable/Fault pin to logic LOW	Flag is reset	Disables secondary output, and resets fault flag.
Over Voltage	Limit output voltage	None	None	None
Thermal Shutdown	Shutdown. The part is latched OFF until a UVLO or externally driven to ground.	Internally drives Enable/Fault pin to MID	Flag is Set	Disables secondary part output.

## APPLICATION INFORMATION

### Current Limit

The current limit is a function of the external current-limit resistor. Table 2 and Table 3 list examples of current values as a function of the resistor value for both Kelvin current sensing and direct current sensing.

### Rise Time

The rise time is a function of the capacitor ( $C_{dv/dt}$ ) on the dv/dt pin. Table 4 lists typical rise times as a function of capacitance.

**Table 2: Current Limit vs. Current Limit Resistor ( $V_{CC}=5V$ , Kelvin Current Sensing)**

<b>R<sub>LIMIT</sub> (Ω)</b>	10	22	51	75	100
<b>Trip Current (A)</b>	2.31	2.18	2.05	2.00	1.99
<b>Hold Current (A)</b>	1.45	1.10	0.71	0.56	0.47

**Table 3: Current Limit vs. Current Limit Resistor ( $V_{CC}=5V$ , Direct Current Sensing)**

<b>R<sub>LIMIT</sub> (Ω)</b>	22	51	75	100	220
<b>Trip Current (A)</b>	4.31	3.10	2.69	2.52	2.31
<b>Hold Current (A)</b>	2.79	1.29	0.91	0.78	0.40

**Table 4: Rise Time vs.  $C_{dv/dt}$**

<b><math>C_{dv/dt}</math></b>	330pF	1nF	3.3nF	6.8nF
<b>Rise Time (typ., ms)</b>	1.1	3	9.4	19.2

\* Notes: Rise Time =  $K_{RT} \cdot (50pF + C_{dv/dt})$ ,  $K_{RT} = 2.8E6$

The “rise time” is measured by from 10% to 90% of output voltage.

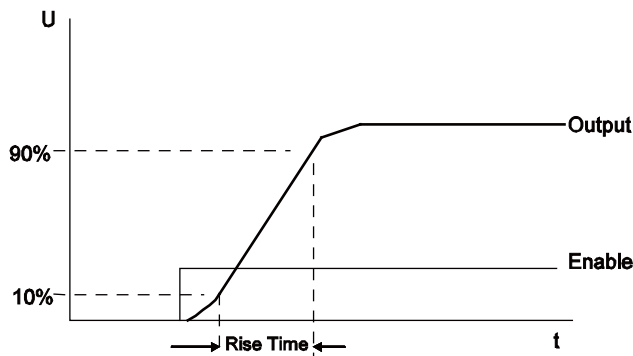

**Figure 2—Rise Time**

### PCB Layout

PCB layout is very important to achieve stable operation. Please follow these guidelines and use Figure 3 as reference.

- Place  $R_{LIMIT}$  close to the I-limit pin
- Place  $C_{dv/dt}$  close to dv/dt pin
- Place the input capacitor close to the  $V_{CC}$  pin.
- Leave the N/C pin floating.
- Place vias in the thermal pad and provide enough copper area near the  $V_{CC}$  pin and Source pin for thermal dissipation.

### Design Example

Below is a direct-current-sensing design example following the application guidelines for the given specifications:

**Table 5: Design Example**

$V_{IN}$	5V
Trip Current	4.3A
Hold Current	2.8A

Figure 5 shows the application schematic. The Typical Performance Characteristics section shows the circuit waveforms. For more device applications, please refer to the related Evaluation Board Datasheet.

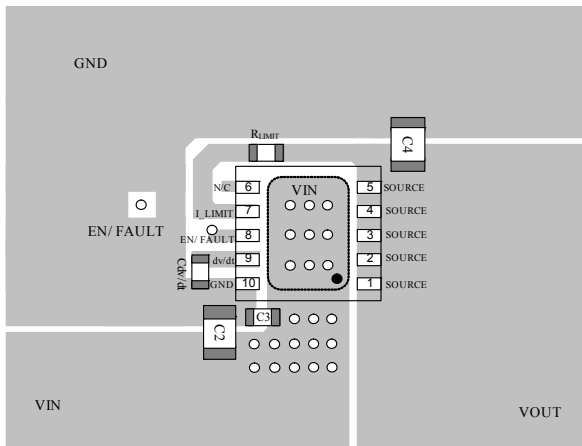

**Top Layer**

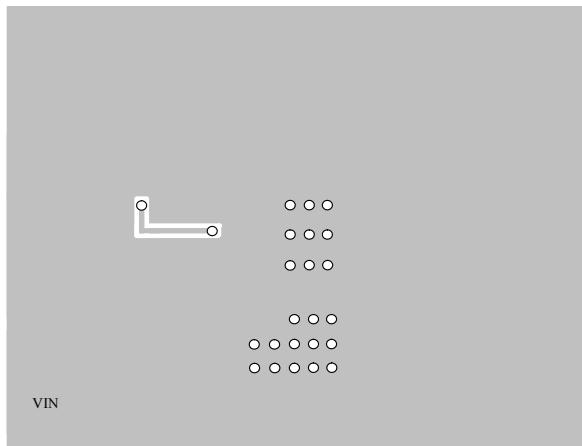

**Bottom Layer**

**Figure 3: PCB Layout**

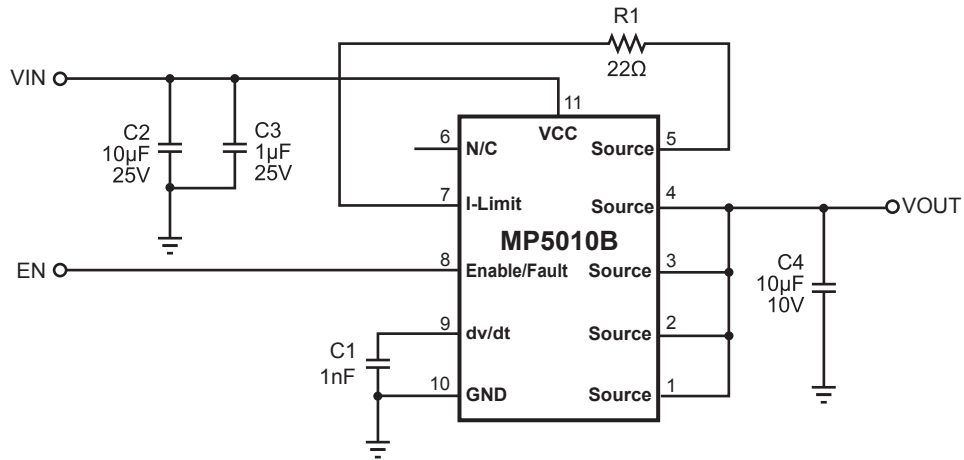
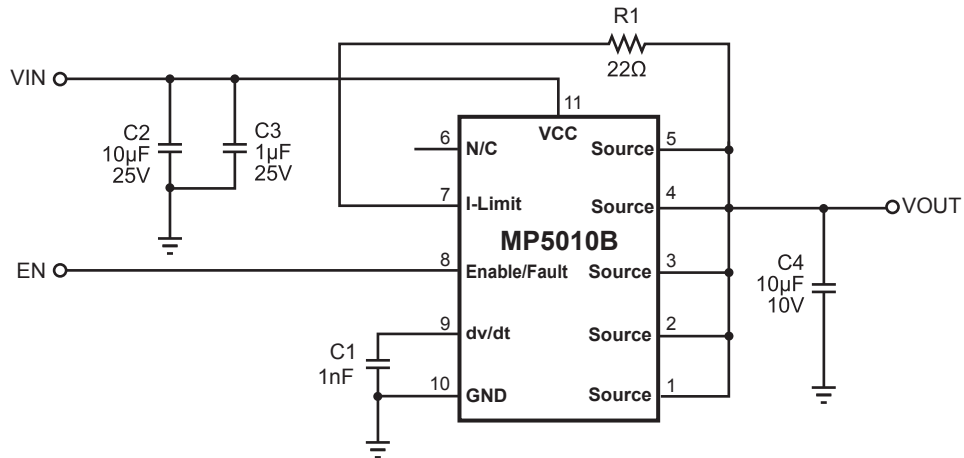
**TYPICAL APPLICATION CIRCUITS**

**Figure 4: Typical Application Schematic with Kelvin Current Sensing**

**Figure 5: Typical Application Schematic with Direct Current Sensing**

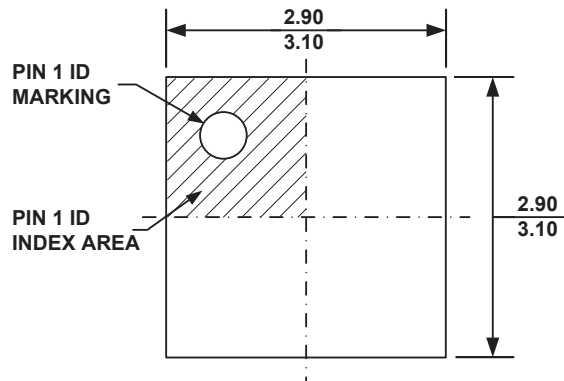
## PACKAGE INFORMATION

### QFN10 (3mm × 3mm)

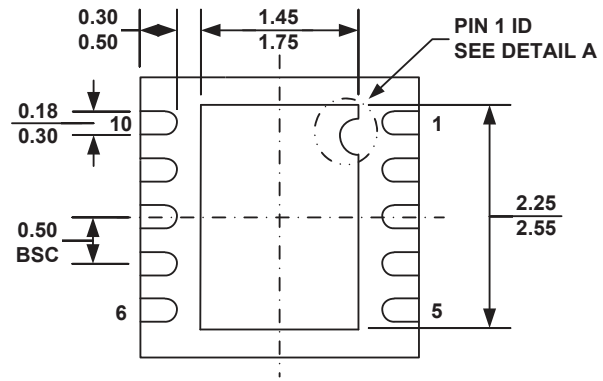

**TOP VIEW**



**BOTTOM VIEW**

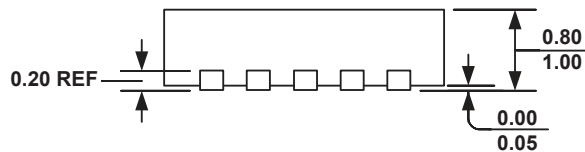

**SIDE VIEW**

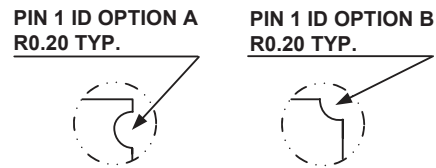

**DETAIL A**

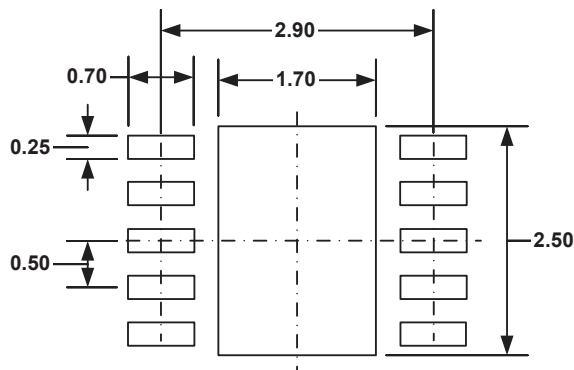

**RECOMMENDED LAND PATTERN**

**NOTE:**

- 1) ALL DIMENSIONS ARE IN MILLIMETERS.
- 2) EXPOSED PADDLE SIZE DOES NOT INCLUDE MOLD FLASH.
- 3) LEAD COPLANARITY SHALL BE 0.10 MILLIMETER MAX.
- 4) DRAWING CONFORMS TO JEDEC MO-229, VARIATION VEED-5.
- 5) DRAWING IS NOT TO SCALE.

**NOTICE:** The information in this document is subject to change without notice. Users should warrant and guarantee that third party Intellectual Property rights are not infringed upon when integrating MPS products into any application. MPS will not assume any legal responsibility for any said applications.