

## DESCRIPTION

The MP4051 is a non-isolated offline LED lighting controller that achieves high power factor and accurate LED current for single-stage PFC lighting applications in a single SOIC8 package.

The MP4051 integrates power factor correction and works in boundary conduction mode to reduce the MOSFET switching losses.

The extremely low start-up current and quiescent current reduces the total power consumption and provides a high-efficiency solution for non-isolated lighting applications.

The multi-protection features of MP4051 greatly enhance system reliability and safety. The MP4051 features over-voltage protection, short-circuit protection, cycle-by-cycle current limiting,  $V_{CC}$  UVLO, and auto-restart over-temperature protection.

## FEATURES

- Unique Architecture for Superior Line Regulation
- Achieve <1% Line and Load Regulation
- High Power Factor  $\geq 0.9$  Over Universal Input Voltage
- Boundary Conduction Mode improves Efficiency
- Ultra-low (20 $\mu$ A) Start-up Current
- Low (1mA) Quiescent Current
- Input UVLO
- Cycle-by-cycle Current Limit
- Over-voltage Protection
- Short-circuit Protection
- Over-temperature Protection
- Available in an SOIC8 Package

## APPLICATIONS

- Solid-state Lighting
- Industrial and Commercial Lighting
- Residential Lighting

All MPS parts are lead-free and adhere to the RoHS directive. For MPS green status, please visit MPS website under Products, Quality Assurance page.

"MPS" and "The Future of Analog IC Technology" are registered trademarks of Monolithic Power Systems, Inc.

The MP4051 is under patent pending.

## TYPICAL APPLICATION (HIGH-SIDE BUCK-BOOST TOPOLOGY)

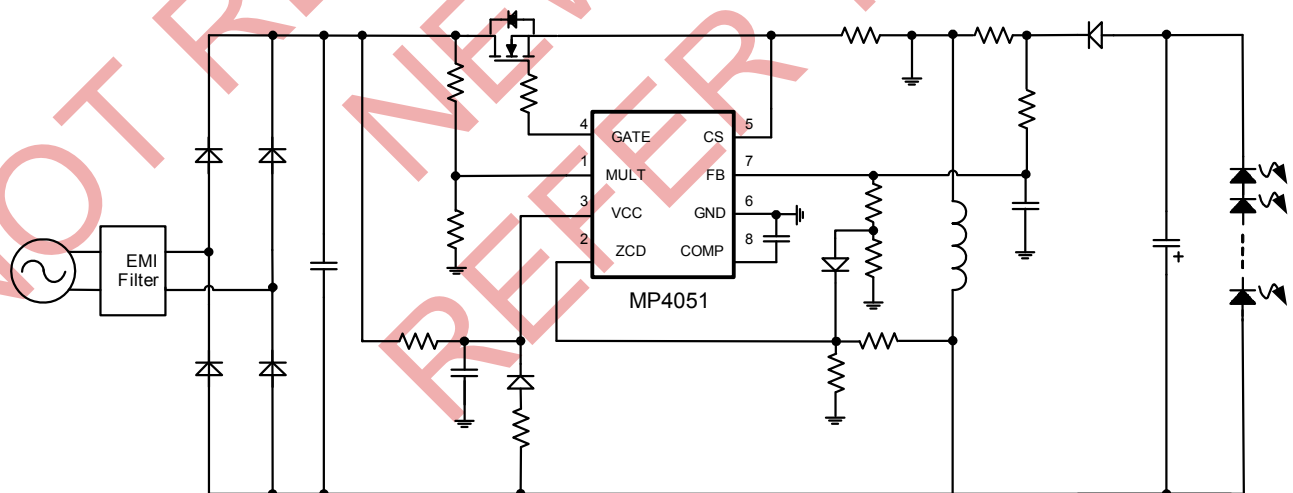

### ORDERING INFORMATION

Part Number*	Package	Top Marking
MP4051GS	SOIC8	MP4051

\* For Tape & Reel, add suffix -Z (e.g. MP4051GS-Z);

### PACKAGE REFERENCE

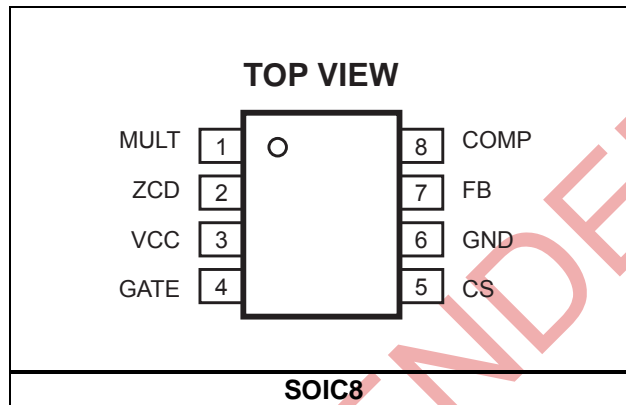

#### ABSOLUTE MAXIMUM RATINGS <sup>(1)</sup>

Input Voltage $V_{CC}$ .....	-0.3V to +30V
ZCD Pin.....	-7V to +7V
Other Analog Inputs and Outputs.....	-0.3V to 7V
Max. Gate Current.....	$\pm 1.2A$
Continuous Power Dissipation ( $T_A = +25^\circ C$ ) <sup>(2)</sup>	
SOIC8.....	1.3W
Junction Temperature.....	150°C
Lead Temperature.....	260°C
Storage Temperature.....	-65°C to +150°C

#### Recommended Operating Conditions <sup>(3)</sup>

Supply Voltage $V_{CC}$ .....	10.3V to 23V
Operating Junction Temp. ( $T_J$ ).....	-40°C to +125°C

#### Thermal Resistance <sup>(4)</sup>

	$\theta_{JA}$	$\theta_{JC}$
SOIC8.....	96	45

**Notes:**

- 1) Exceeding these ratings may damage the device.
- 2) The maximum allowable power dissipation is a function of the maximum junction temperature  $T_J(MAX)$ , the junction-to-ambient thermal resistance  $\theta_{JA}$ , and the ambient temperature  $T_A$ . The maximum allowable continuous power dissipation at any ambient temperature is calculated by  $P_D(MAX) = (T_J(MAX) - T_A) / \theta_{JA}$ . Exceeding the maximum allowable power dissipation will cause excessive die temperature, and the regulator will go into thermal shutdown. Internal thermal shutdown circuitry protects the device from permanent damage.
- 3) The device is not guaranteed to function outside of its operation conditions.
- 4) Measured on JESD51-7 4-layer board.

## ELECTRICAL CHARACTERISTICS

$V_{CC} = 14V$ ,  $T_A = +25^{\circ}C$ , unless otherwise noted.

Parameter	Symbol	Condition	Min	Typ	Max	Units
<b>Supply Voltage</b>						
Operating Range	$V_{CC}$	After turn on	10.3		23	V
Turn-on Threshold	$V_{CC\_ON}$	$V_{CC}$ rising edge	12.6	13.6	14.6	V
Turn-off Threshold	$V_{CC\_OFF}$	$V_{CC}$ falling edge	8.4	9.0	9.6	V
Hysteretic Voltage	$V_{CC\_HYS}$			4.5		V
<b>Supply Current</b>						
Start-up Current	$I_{STARTUP}$	$V_{CC}=11V$		20	30	$\mu A$
Quiescent Current	$I_Q$	No switching		0.75	1	mA
Operating Current	$I_{CC}$	$F_s = 70kHz$		2	3	mA
<b>Multiplier</b>						
Operation Range	$V_{MULT}$		0		3	V
Gain	$K^{(5)}$			1		1/V
<b>Error Amplifier</b>						
Feedback Voltage	$V_{FB}$		0.403	0.414	0.425	V
Transconductance <sup>(6)</sup>	$G_{EA}$			222		$\mu A/V$
Upper Clamp Voltage	$V_{COMP\_H}$		5.3	5.65	6	V
Lower Clamp Voltage	$V_{COMP\_L}$		1.3	1.5	1.7	V
Max Source Current <sup>(6)</sup>	$I_{COMP}$			75		$\mu A$
Max Sink Current <sup>(6)</sup>	$I_{COMP}$			-400		$\mu A$
<b>Current Sense Comparator</b>						
Leading Edge Blanking Time	$t_{LEB}$			280		ns
Current Sense Clamp Voltage	$V_{CS\_CLAMP}$		2.3	2.5	2.7	V
<b>Zero Current Detector</b>						
Zero Current Detect threshold	$V_{ZCD\_T}$	$V_{ZCD}$ falling edge		0.31		V
Zero Current Detect Hysteresis	$V_{ZCD\_HYS}$			650		mV
ZCD Blanking Time	$t_{LEB\_ZCD}$	After turn-off	1.8	2.5	3.2	$\mu s$
Over-voltage Blanking Time	$t_{LEB\_OVP}$	After turn-off		1.5		$\mu s$
Over-voltage Threshold	$V_{ZCD\_OVP}$	1.5 $\mu s$ delay after turn-off	5.1	5.4	5.7	V
Over-current Blanking Time	$t_{LEB\_OCP}$	After turn-on, same as $t_{LEB}$		280		ns
Over-current Threshold	$V_{ZCD\_OCP}$	280ns delay after turn-on	0.57	0.60	0.63	V
Minimum Off Time	$t_{OFF\_MIN}$		2	3.5	5	$\mu s$
<b>Starter</b>						
Start Timer Period	$t_{START}$			130		$\mu s$

**ELECTRICAL CHARACTERISTICS** *(Continued)*
 $V_{CC} = 14V$ ,  $T_A = +25^{\circ}C$ , unless otherwise noted.

Parameter	Symbol	Condition	Min	Typ	Max	Units
<b>Gate Driver</b>						
Output Clamp Voltage	$V_{GATE\_CLAMP}$	$V_{CC}=23V$	12	13.5	15	V
Minimum Output Voltage	$V_{GATE\_MIN}$	$V_{CC}=V_{CC\_OFF} + 50mV$	6.0			V
Max Source Current <sup>(6)</sup>	$I_{GATE\_SOURCE}$			1		A
Max Sink Current <sup>(6)</sup>	$I_{GATE\_SINK}$			-1.2		A

**Notes:**

 5) The multiplier output is given by:  $V_{CS}=K \cdot V_{MULT} \cdot (V_{COMP}-1.5)$ 

6) Guaranteed by design.

NOT RECOMMENDED FOR NEW DESIGNS REFER TO MP4054

## PIN FUNCTIONS

Pin #	Name	Pin Function
1	MULT	Multiplier input. Connect this pin to the tap of resistor divider from the rectified voltage of the AC line. The half-wave sinusoid signal to this pin provides a reference signal for the internal current control loop.
2	ZCD	Zero-current detection. A negative going-edge triggers the turn-on signal of the external MOSFET. Connect this pin to a resistor divider between the auxiliary winding to GND. Over-voltage condition is detected through ZCD. Every switching turn-off interval, if ZCD voltage is higher than the over-voltage-protection (OVP) threshold after the 1.5 $\mu$ s blanking time, the over-voltage protection will be triggered and the system will stop switching until auto-restart comes. ZCD pin can also monitor over-current condition. Connect this pin thru a diode to a resistor divider between CS to GND. Every switching turn-on interval, if ZCD voltage is higher than the over-current-protection (OCP) threshold after the 280ns blanking time, the over-current protection will trigger and the system will stop switching until auto-restart comes.
3	VCC	Power supply input. This pin supplies the power for the control signal and the high-current MOSFET grade drive output. Bypass this pin to ground with an external bulk capacitor of typically 22 $\mu$ F in parallel with a 100pF ceramic cap to reduce noise.
4	GATE	Gate drive output. This totem pole output stage is able to drive a high-power MOSFET with a peak current of 1A source capability and 1.2A sink capability. The high level voltage of this pin is clamped to 13.5V to avoid excessive gate drive voltage. And the low level voltage is higher than 6V to guarantee enough drive capacity.
5	CS	Current sense. The MOSFET current is sensed via a sensing resistor to its source lead. The comparison between the resulting voltage and the internal sinusoidal-current reference signal determines when the MOSFET turns off. In Buck-Boost solution (both high side and low side), CS Pin is also used for current sample. A feed-forward from the rectified AC line voltage connected to the current sense pin maximizes the line regulation. If the pin voltage is higher than the current limit threshold of 2.5V (after turn-on blanking) the gate drive will turn off.
6	GND	Ground. Current return for the control signal and the gate drive signal.
7	FB/NC	Feedback signal. This Pin is used for current sample in high side Buck-Boost or Buck, and it's benefit for load regulation to sample the current through FB Pin. Leave this pin floating (NC) in low side Buck-Boost solution.
8	COMP	Loop compensation input. Connect a compensation network to stabilize the LED drive and maintain an accurate LED current.

**TYPICAL PERFORMANCE CHARACTERISTICS**

$V_{IN} = 120V_{AC}/220V_{AC}$ ,  $V_O = 300V$ ,  $I_{LED} = 80mA$ ,  $L_m = 1.88mH$ ,  $N_P:N_{AUX} = 161:13$ , unless otherwise noted.

**PF & THD vs.  $V_{IN}$**

$V_{OUT} = 300V$

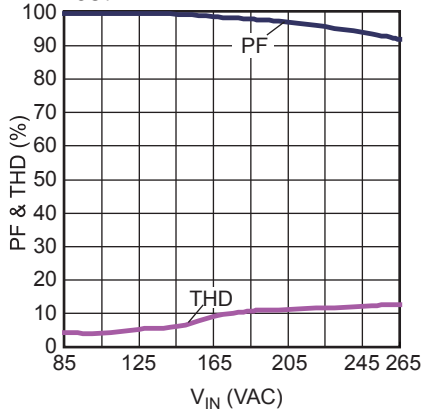

**Efficiency vs.  $V_{IN}$**

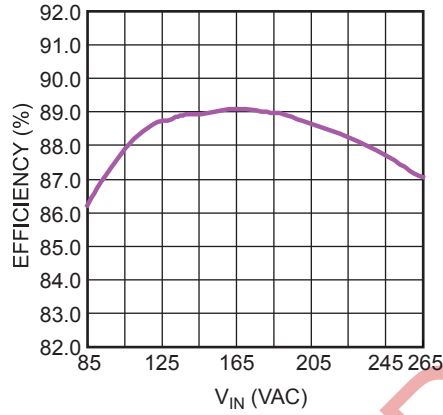

**Conducted EMI**

$V_{IN} = 120Vac/60Hz$ , Full Load

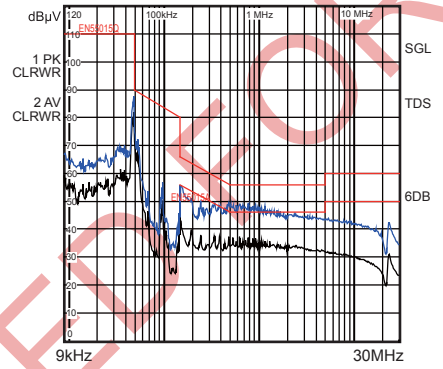

**Conducted EMI**

$V_{IN} = 220Vac/50Hz$ , Full Load

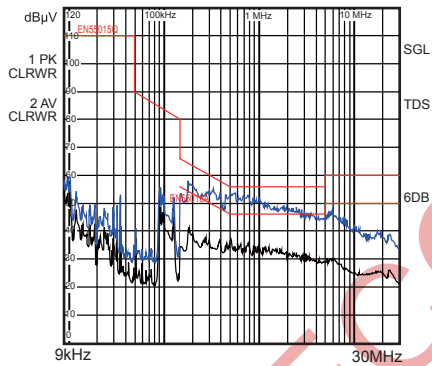

NOT RECOMMENDED FOR NEW DESIGNS REFER TO MP4054

**TYPICAL PERFORMANCE CHARACTERISTICS (continued)**

$V_{IN} = 120V_{AC}/220V_{AC}$ ,  $V_O = 300V$ ,  $I_{LED} = 80mA$ ,  $L_m = 1.88mH$ ,  $N_P:N_{AUX} = 161:13$ , unless otherwise noted.

**Steady State**

$V_{IN} = 120Vac/60Hz$ , Full Load

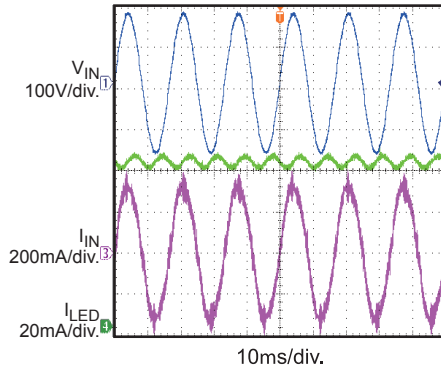

**Steady State**

$V_{IN} = 120Vac/60Hz$ , Full Load

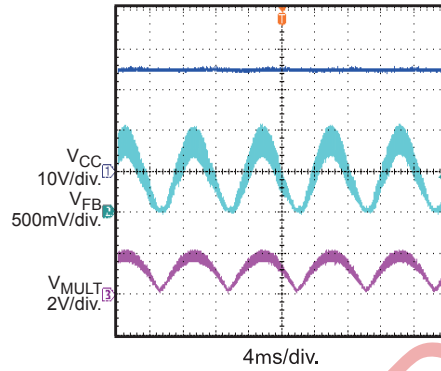

**Steady State**

$V_{IN} = 120Vac/60Hz$ , Full Load

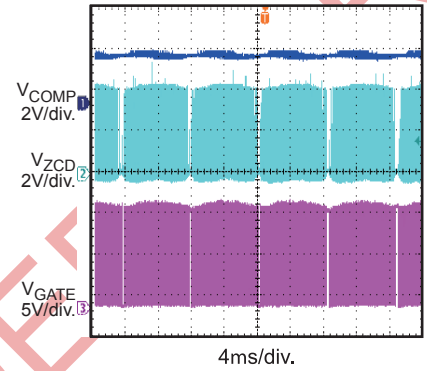

**Steady State**

$V_{IN} = 220Vac/50Hz$ , Full Load

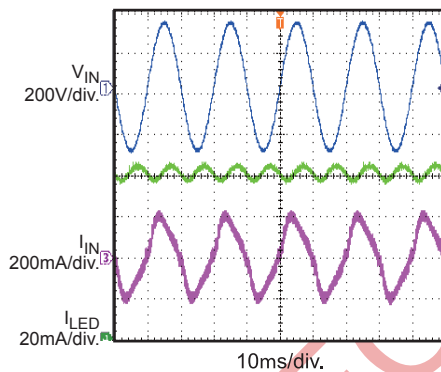

**Steady State**

$V_{IN} = 220Vac/50Hz$ , Full Load

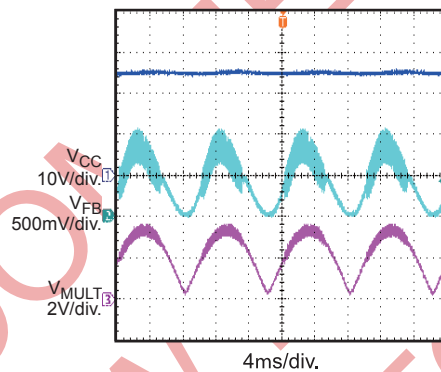

**Steady State**

$V_{IN} = 220Vac/50Hz$ , Full Load

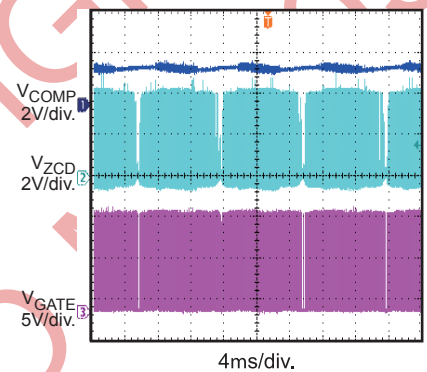

**Start Up**

$V_{IN} = 120Vac/60Hz$ , Full Load

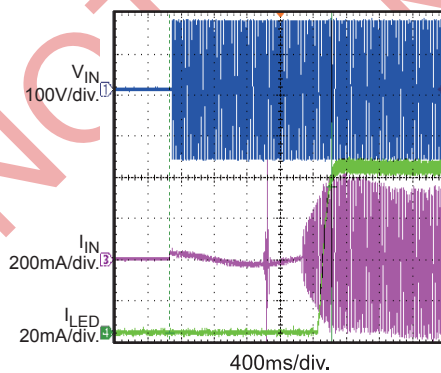

**Start Up**

$V_{IN} = 220Vac/50Hz$ , Full Load

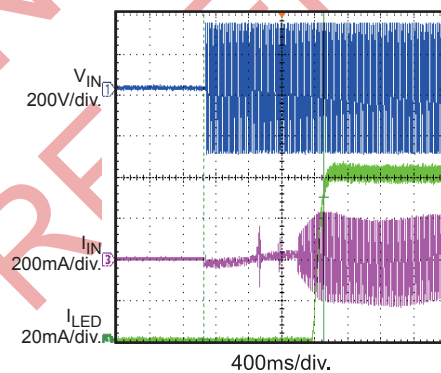

**SCP**

when Working then Recover  
 $V_{IN} = 120Vac/60Hz$ , Full Load

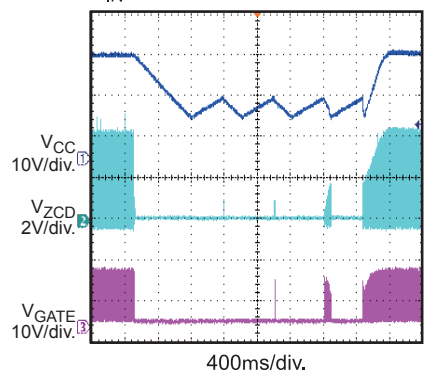

**TYPICAL PERFORMANCE CHARACTERISTICS** *(continued)*

$V_{IN} = 120V_{AC}/220V_{AC}$ ,  $V_O = 300V$ ,  $I_{LED} = 80mA$ ,  $L_m = 1.88mH$ ,  $N_P:N_{AUX} = 161:13$ , unless otherwise noted.

**SCP**

when Working then Recover  
 $V_{IN} = 220Vac/50Hz$ , Full Load

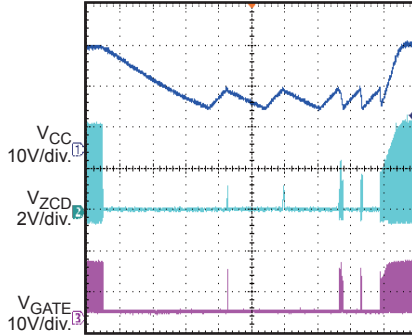

400ms/div.

**OVP**

when Working then Recover  
 $V_{IN} = 120Vac/60Hz$ , Full Load

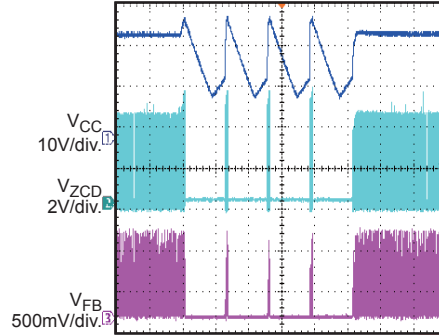

1s/div.

**OVP**

when Working then Recover  
 $V_{IN} = 120Vac/60Hz$ , Full Load

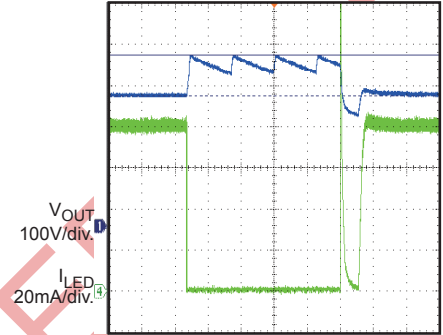

1s/div.

**OVP**

when Working then Recover  
 $V_{IN} = 220Vac/50Hz$ , Full Load

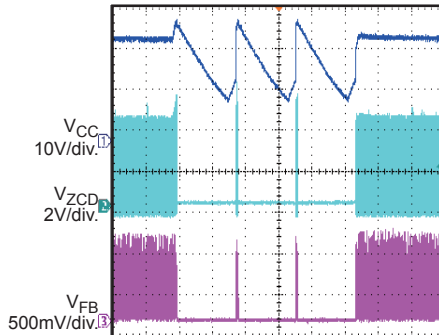

1s/div.

**OVP**

when Working then Recover  
 $V_{IN} = 220Vac/50Hz$ , Full Load

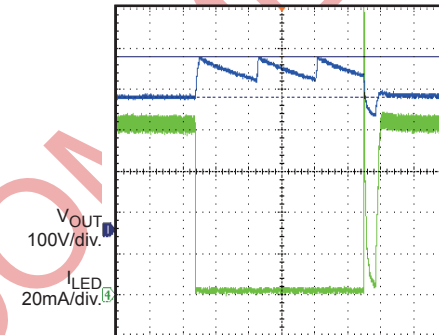

1s/div.



FUNCTION DIAGRAM

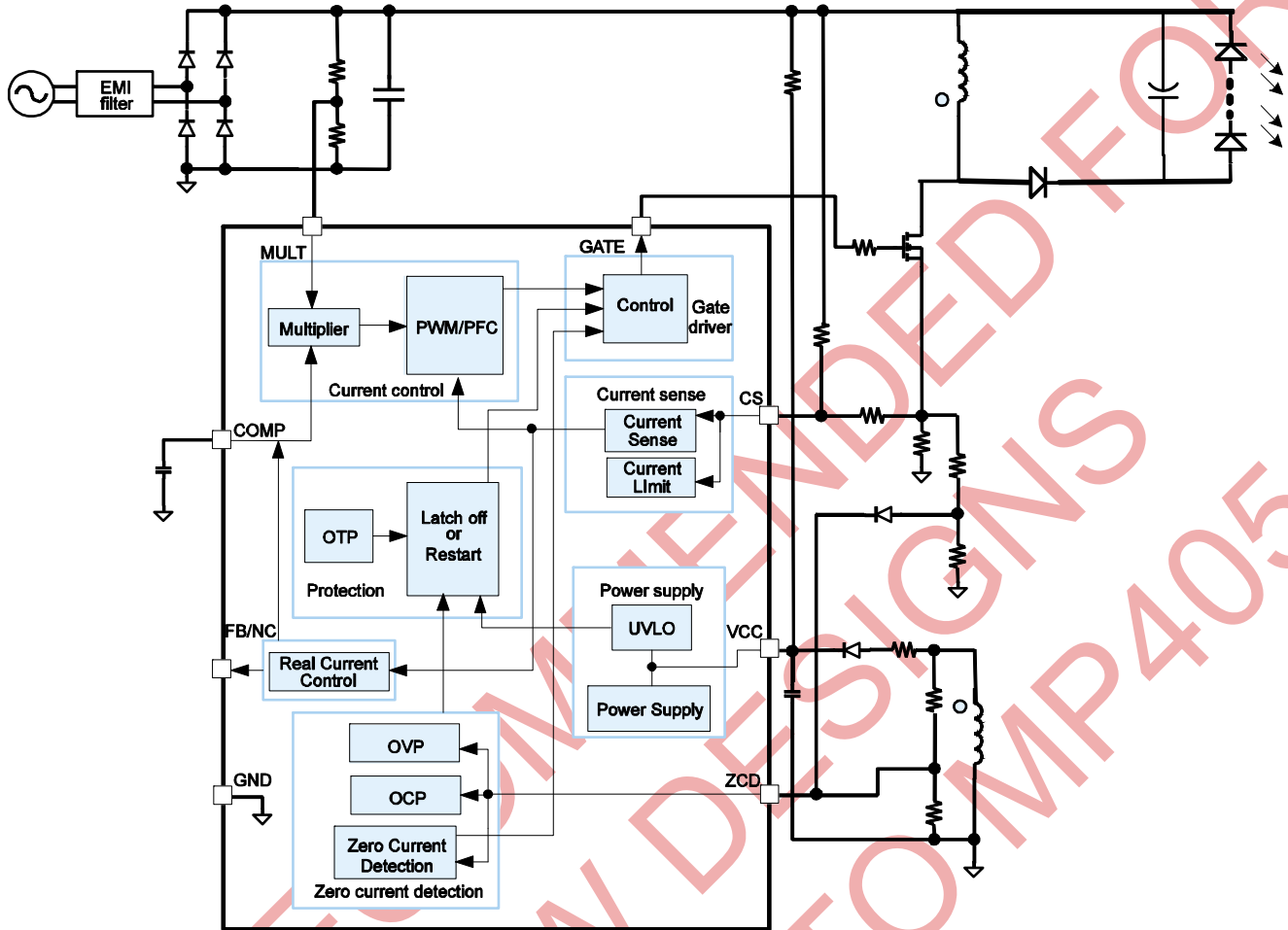

Figure 1—MP4051 Function Block Diagram

## OPERATION

The MP4051 is a non-isolated control offline LED controller which incorporates all the features for high-performance LED lighting. Active Power Factor Correction (PFC) eliminates unwanted harmonic noise to pollute the AC line.

### Start Up

Initially, VCC of the MP4051 is charged through the start up resistor from the AC line. When VCC reaches 13.6V, the control logic works and the gate drive signal begins to switch. Then the power supply is taken over by the auxiliary winding.

The MP4051 will shut down when VCC drops below 9V.

### Boundary Conduction Mode Operation

During the external MOSFET on time ( $t_{ON}$ ), the rectified input voltage ( $V_{BUS}$ ) applies to the inductor ( $L_m$ ), and the inductor current ( $I_{Lm}$ ) increases linearly from zero to the peak value ( $I_{pk}$ ). When the external MOSFET turns off, the output diode is turned on and the energy stored in the inductor is transferred to the load. Then the inductor current ( $I_{Lm}$ ) begins to decrease linearly from the peak value to zero. The auxiliary winding is coupled with the inductor to supply the Vcc voltage and turn on signal detection for ZCD. The zero-current detector in the ZCD pin generates the turn-on signal of the external MOSFET when the ZCD voltage falls below 0.31V (see Figure 3).

As a result, there are virtually no MOSFET turn-on losses and no output-diode reverse-recover losses. It ensures high efficiency and low EMI noise.

### Real Current Control

In high-side solution (including both Buck and Buck-Boost), the current is controlled through FB Pin, the mean output LED current is directly sampled by FB pin, so the load regulation of high-side solution is good. The output LED current can be set as:

$$I_o = \frac{V_{FB}}{R_{FB}}$$

In low-side Buck-Boost, the mean output LED current is calculated through the peak current sensed from the MOSFET (through CS Pin). And the mean output LED current can be calculated approximately as:

$$I_o \approx \frac{V_{FB}}{2 \cdot R_s}$$

$V_{FB}$ —The feedback reference voltage (typical 0.4V)

$R_{FB}$ —The sensing resistor connected between the FB RC filter and GND in high-side solution.

$R_s$ —The sensing resistor connected between the MOSFET source and GND in low-side Buck-Boost.

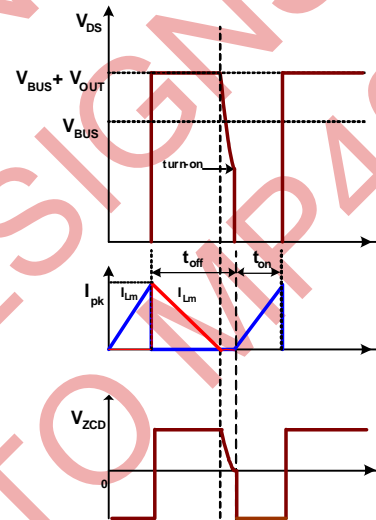

Figure 2—Boundary Conduction Mode (Buck-Boost for example)

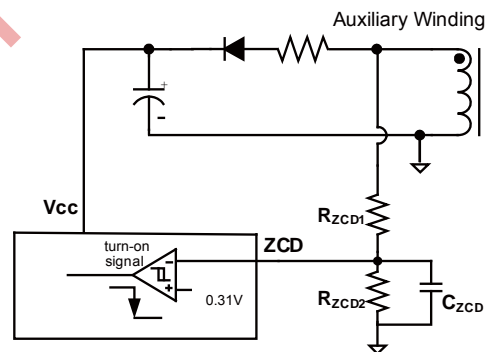
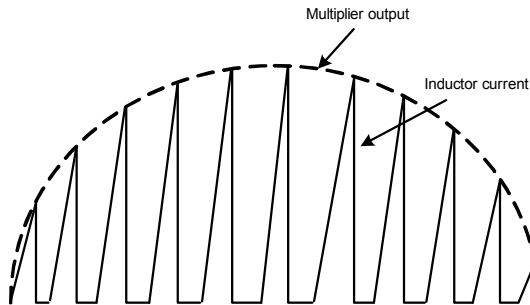

Figure 3—Zero Current Detector

**Power Factor Correction**

The MULT pin is connected to the tap of the resistor divider from the rectified instantaneous line voltage and fed as one input of the Multiplier. The output of the multiplier will be shaped as sinusoid too. This signal provides the reference for the current comparator and comparing with the inductor current which sets the inductor peak current shaped as sinusoid with the input line voltage. High power factor can be achieved.

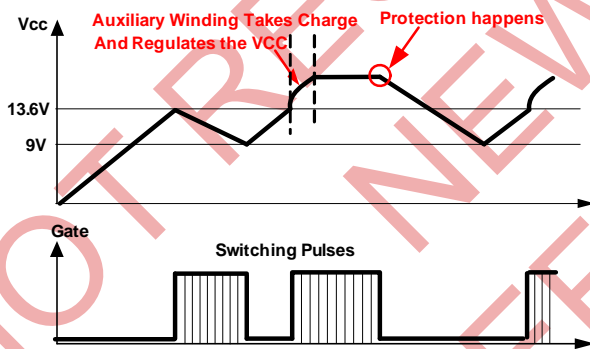

**Figure 4—Power Factor Correction Scheme**

The maximum voltage of the multiplier output to the current comparator is clamped to 2.5V to get a cycle-by-cycle current limitation.

**VCC Under-voltage Lockout**

When the VCC voltage drops below UVLO threshold 9V, the MP4051 stops switching and totally shuts down, the VCC will restart charging by the external start up resistor from AC line. Figure 5 shows the typical waveform of VCC under-voltage lockout



**Figure 5—VCC Under-Voltage Lockout**

**Auto Starter**

The MP4051 integrates an auto starter, the starter starts timing when the MOSFET is turned

off, if ZCD fails to send out another turn on signal after 130μs, the starter will automatically send out the turn on signal which can avoid the IC unnecessary shut down by ZCD missing detection.

**Minimum Off Time**

The MP4051 operates with variable switching frequency, the frequency is changing with the input instantaneous line voltage. To limit the maximum frequency and get a good EMI performance, MP4051 employs an internal minimum off time limiter—3.5μs, show as Figure 6.

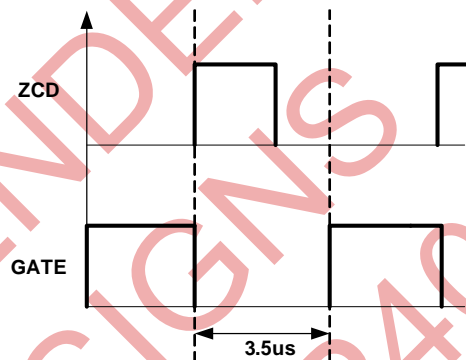

**Figure 6—Minimum Off Time**

**Leading Edge Blanking**

In order to avoid the premature termination of the switching pulse due to the spike at MOSFET turning on, an internal leading edge blanking (LEB) unit is employed between the CS Pin and the current comparator input. During the blanking time, the path, CS Pin to the current comparator input, is blocked. Figure 7 shows the leading edge blanking.

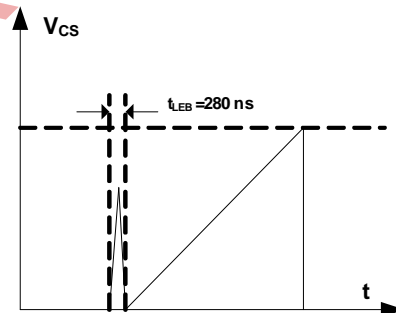

**Figure 7—Leading Edge Blanking**

**Output Over-Voltage Protection (OVP)**

Output over voltage protection can prevent the components from damage in the over voltage condition. The positive plateau of auxiliary winding voltage is proportional to the output voltage, the OVP uses the auxiliary winding voltage instead of directly monitoring the output voltage, the OVP sample is shown in Figure 8. Once the ZCD pin voltage is higher than 5.4V after a 1.5us blanking time, the OVP signal will be triggered and latched, the gate driver will be turned off and the IC work at quiescent mode, the VCC voltage dropped below the UVLO which will make the IC shut down and the system restarts again. The output OVP setting point can be calculated as:

$$V_{OUT\_OVP} \cdot \frac{N_{AUX}}{N_{SEC}} \cdot \frac{R_{ZCD2}}{R_{ZCD1} + R_{ZCD2}} = 5.4V$$

$V_{OUT\_OVP}$ —Output over voltage protection point

$N_{AUX}$ —The auxiliary winding turns

$N_{SEC}$ —The secondary winding turns

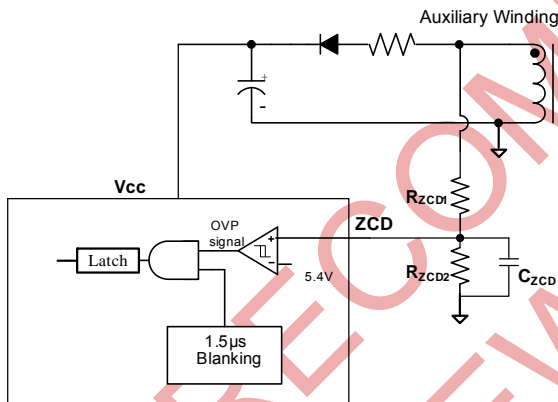

**Figure 8—OVP Sample Unit**

To avoid the mis-trigger OVP by the oscillation spike after the switch turns off, the OVP sampling has a  $t_{LEB\_OVP}$  blanking period, typical 1.5µs, shown in Figure 9.

The current-limiting resistor between the output of the aux-winding and the ZCD resistor divider can also work as suppresser to avoid the OVP mis-trigger.

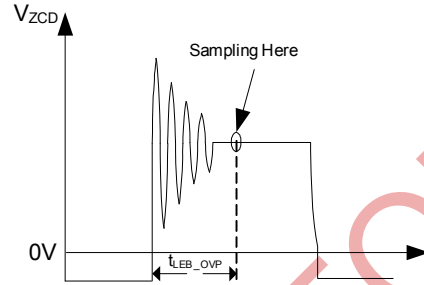
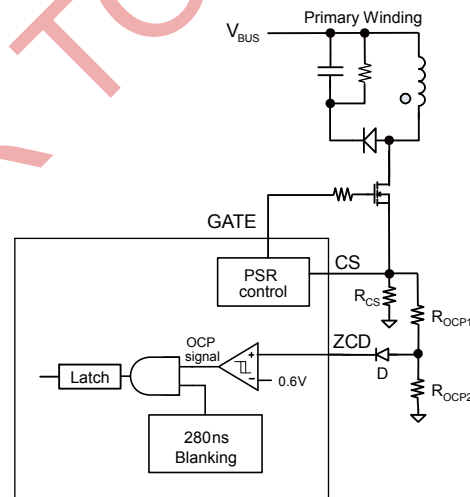

**Figure 9—ZCD Voltage and OVP Sample**

**Output Short Circuit Protection**

The MP4051 clamps the CS pin voltage to less than 2.5V to limit the available output power. When the short circuit of the LED load occurs, the voltage of the auxiliary winding will fall down following the voltage of the Load and the VCC drops to less than UV threshold and re-start the system.

As supplementary, tie a resistor divider from CS sensing resistor to ZCD pin, shown in Figure 10. When the power MOSFET is turned on, the ZCD pin monitors the rising inductor current, once the ZCD pin reaches OCP threshold, typical 0.6V, the gate driver will be turned off to prevent the chip form damage and the IC works at quiescent mode, the VCC voltage dropped below the UVLO which will make the IC shut down and the system restarts again. Please note that the value of the resistors to set the OCP threshold ( $R_{OCP1}$  &  $R_{OCP2}$ ) should be much smaller than those of the ZCD zero-current detector ( $R_{ZCD1}$  &  $R_{ZCD2}$ ).



**Figure 10—OCP Sample Unit**

The OCP setting point can be calculated as:

$$I_{PRI\_OCP} \cdot R_{CS} \cdot \frac{R_{OCP2}}{R_{OCP1} + R_{OCP2}} - V_D = 0.6V$$

$I_{PRI\_OCP}$ —Primary-side over current protection point.

For some applications, the inductor value is very small, the minimal-off time feature could make the system work in DCM at the zero-crossing of the BUS voltage. To improve the OCP function in this condition, please remove  $C_{ZCD}$  and reduce the value of  $R_{ZCD1}$  and  $R_{ZCD2}$  proportionally.

### Thermal Shut Down

To prevent from any lethal thermal damage, when the inner temperature exceeds OTP threshold, the MP4051 shuts down switching cycle and latched until VCC drop below UVLO and restart again.

### Design Example

For the design example, please refer to MPS application note AN0xx for the detailed design procedure and information.

NOT RECOMMENDED FOR NEW DESIGNS REFER TO MP4054

TYPICAL APPLICATION CIRCUIT

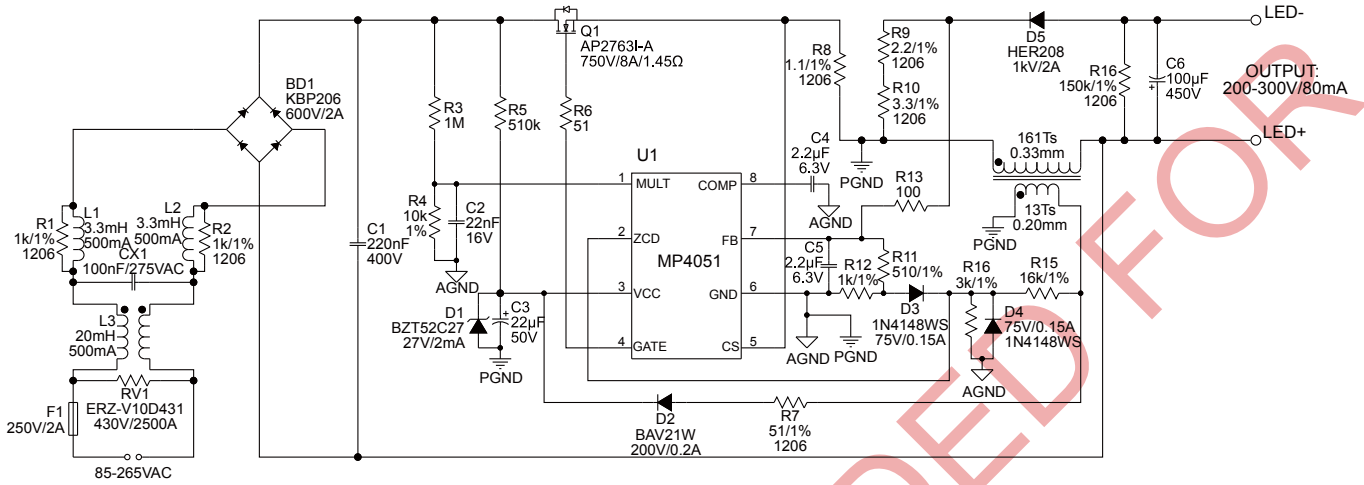

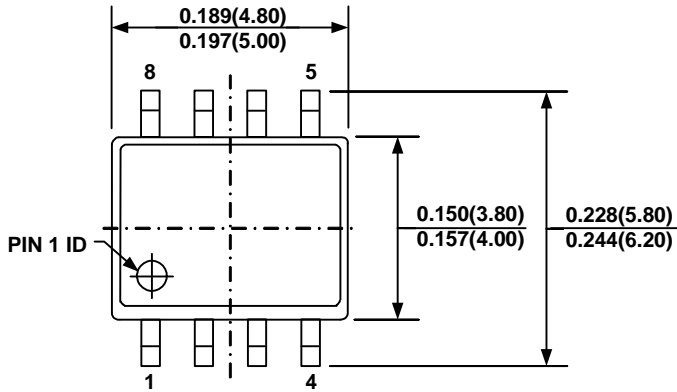
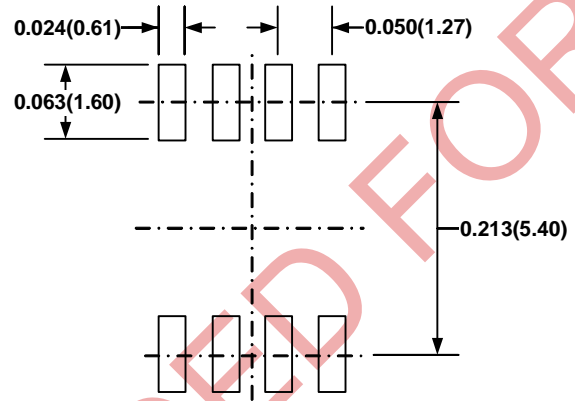
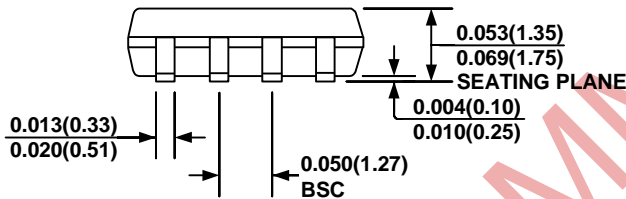
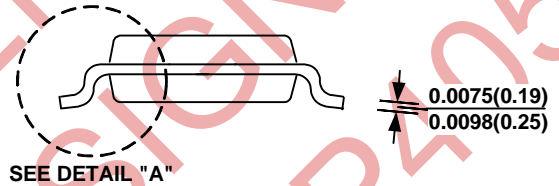
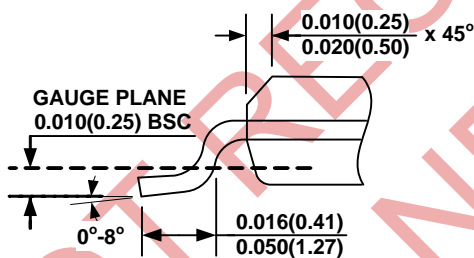

**PACKAGE INFORMATION**
**SOIC8**

**TOP VIEW**

**RECOMMENDED LAND PATTERN**

**FRONT VIEW**

**SIDE VIEW**

**DETAIL "A"**
**NOTE:**

- 1) CONTROL DIMENSION IS IN INCHES. DIMENSION IN BRACKET IS IN MILLIMETERS.
- 2) PACKAGE LENGTH DOES NOT INCLUDE MOLD FLASH, PROTRUSIONS OR GATE BURRS.
- 3) PACKAGE WIDTH DOES NOT INCLUDE INTERLEAD FLASH OR PROTRUSIONS.
- 4) LEAD COPLANARITY (BOTTOM OF LEADS AFTER FORMING) SHALL BE 0.004" INCHES MAX.
- 5) DRAWING CONFORMS TO JEDEC MS-012, VARIATION AA.
- 6) DRAWING IS NOT TO SCALE.

**NOTICE:** The information in this document is subject to change without notice. Users should warrant and guarantee that third party Intellectual Property rights are not infringed upon when integrating MPS products into any application. MPS will not assume any legal responsibility for any said applications.