

DESCRIPTION

The MP3398A is a step-up controller with 4 current channels, which is designed to drive WLED arrays for large-size LCD-panel backlighting applications. It is flexible to expand the number of LED channels by two or more ICs in parallel sharing a single inductive power source.

The MP3398A uses peak-current mode with fixed switching frequency. The frequency is programmable by an external setting resistor. The MP3398A drives an external MOSFET to boost up the output voltage from a 5V to 28V input supply. It regulates the current in each LED string to the value set by an external current-setting resistor.

The MP3398A applies 4 internal current sources for current balance. The current matching can achieve 2.5% regulation accuracy between strings. Its low regulation voltage on LED current sources reduces power loss.

The MP3398A can support both analog and PWM dimming independently to meet the different dimming-mode request. In addition, rich protection modes are also integrated including OCP, OTP, UVP, OVP, LED short/open protection, inductor/diode short protection.

The MP3398A is available in SOIC16, TSSOP16-EP and SOIC20 packages.

FEATURES

- 4-String, Max 350mA/String WLED Driver
- 5V to 28V Input Voltage Range
- 2.5% Current Matching Accuracy Between Strings
- Programmable Switching Frequency
- PWM and Analog Dimming Mode
- Cascading Capability with a Single Power Source
- LED Open and Short LED Protection
- Programmable Over-Voltage Protection
- Recoverable Thermal Shutdown Protection
- Over Current Protection
- Inductor/Diode short Protection
- Under-Voltage Lockout
- SOIC16, TSSOP16-EP and SOIC20 Packages

APPLICATIONS

- Desktop LCD Flat Panel Displays
- Flat Panel Video Displays
- 2D/3D LCD TVs and Monitors

All MPS parts are lead-free, halogen free, and adhere to the RoHS directive. For MPS green status, please visit MPS website under Quality Assurance.

"MPS" and "The Future of Analog IC Technology" are Registered Trademarks of Monolithic Power Systems, Inc.

TYPICAL APPLICATION

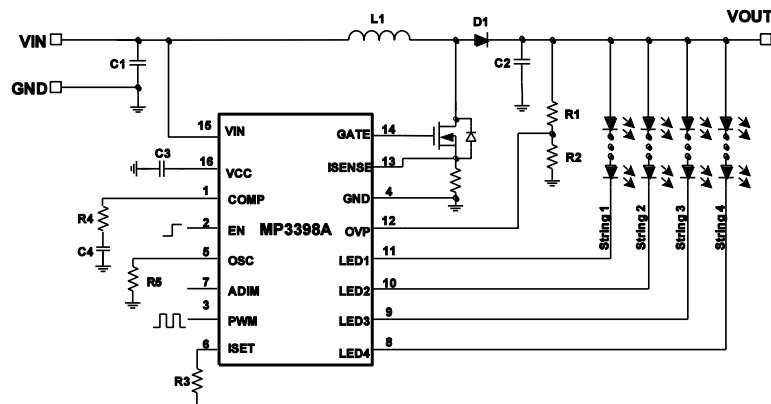

ORDERING INFORMATION

| Part Number | Package | Top Marking |
|--------------|------------|-------------|
| MP3398AGS* | SOIC16 | See Below |
| MP3398AGF** | TSSOP16-EP | See Below |
| MP3398AGY*** | SOIC20 | See Below |

- * For Tape & Reel, add suffix -Z (e.g. MP3398AGS-Z);
- ** For Tape & Reel, add suffix -Z (e.g. MP3398AGF-Z);
- *** For Tape & Reel, add suffix -Z (e.g. MP3398AGY-Z);

TOP MARKING (MP3398AGS)

MPSYYWW
MP3398A
LLLLLLLLL

MPS: MPS prefix;
YY: year code;
WW: week code;
MP3398A: part number;
LLLLLLLLL: lot number;

TOP MARKING (MP3398AGF)

MPSYYWW
MP3398A
LLLLLL

MPS: MPS prefix;
YY: year code;
WW: week code;
MP3398A: part number;
LLLLLL: lot number;

TOP MARKING (MP3398AGY)

MPSYYWW
MP3398A
LLLLLLLLL

MPS: MPS prefix;
YY: year code;
WW: week code;
MP3398A: part number;
LLLLLLLLL: lot number;

PACKAGE REFERENCE

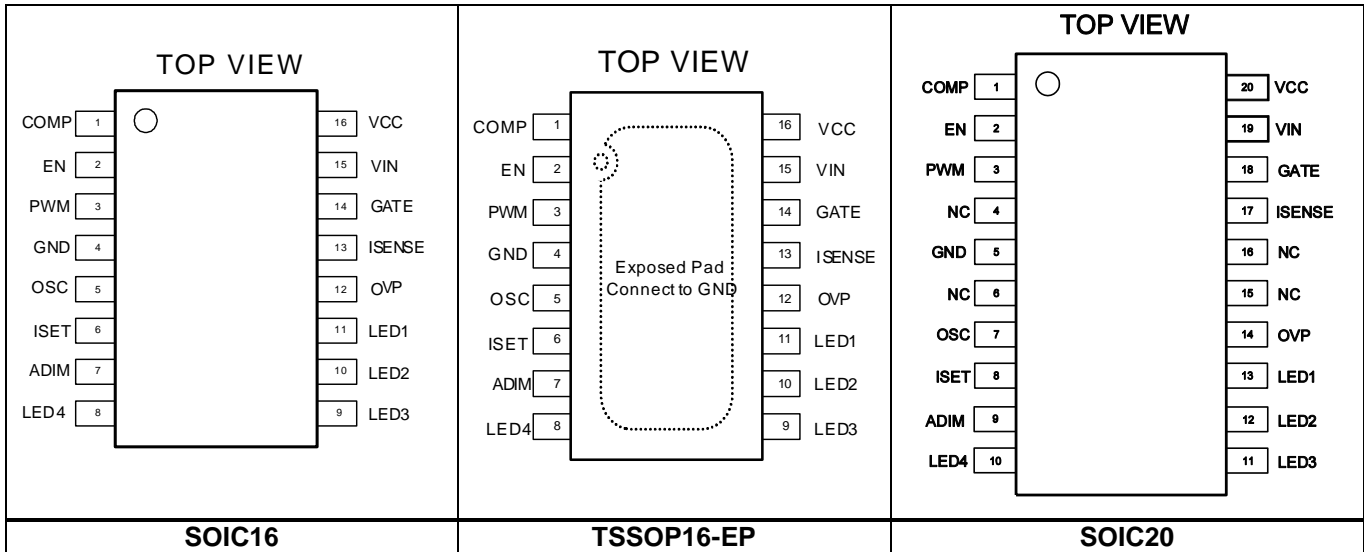

Absolute Maximum Ratings ⁽¹⁾

| | |
|---|--------------------------|
| V _{IN} | -0.3V to +30V |
| V _{GATE} | -0.3V to +6.5V |
| V _{CC} | -0.3V to +6.8V |
| V _{LED1} to V _{LED4} | -1V to +55V |
| V _{ISENSE} | -0.5V to +6.5V |
| All Other Pins | -0.3V to V _{CC} |
| Continuous Power Dissipation (T_A = 25°C) ⁽²⁾ | |
| SOIC16 | 1.56W |
| TSSOP16-EP | 2.78W |
| SOIC20 | 1.74W |
| Junction Temperature | 150°C |
| Lead Temperature | 260°C |
| Storage temperature | -60°C to +150°C |
| ESD Capability Human Body Mode (all pins) | 3.5kV |

Recommended Operating Conditions ⁽³⁾

| | |
|--|-----------------|
| Supply Voltage V _{IN} | 5V to 28V |
| LED Current (Backlight) | 10mA to 350mA |
| Operating Junction Temp. (T _J) | -40°C to +125°C |

| Thermal Resistance ⁽⁴⁾ | θ_{JA} | θ_{JC} |
|--|-----------------------|-----------------------|
| SOIC16 | 80 | 35 |
| TSSOP16-EP | 45 | 10 |
| SOIC20 | 72 | 30 |

Notes:

- 1) Exceeding these ratings may damage the device. The voltage is measured with a 20MHz bandwidth limited oscilloscope.
- 2) The maximum allowable power dissipation is a function of the maximum junction temperature T_J (MAX), the junction-to-ambient thermal resistance θ_{JA}, and the ambient temperature T_A. The maximum allowable continuous power dissipation at any ambient temperature is calculated by P_D (MAX) = (T_J (MAX) - T_A) / θ_{JA}. Exceeding the maximum allowable power dissipation will cause excessive die temperature, and the regulator will go into thermal shutdown. Internal thermal shutdown circuitry protects the device from permanent damage.
- 3) The device is not guaranteed to function outside of its operating conditions.
- 4) Measured on JESD51-7, 4-layer PCB.

ELECTRICAL CHARACTERISTICS ⁽⁵⁾
 $V_{IN} = 12V$, $V_{EN} = 5V$, $T_A = 25^{\circ}C$, unless otherwise noted.

| Parameters | Symbol | Condition | Min | Typ | Max | Units |
|-------------------------------------|------------------|--|-------|------|-------|-----------|
| Operating Input Voltage | V_{IN} | | 5 | | 28 | V |
| Supply Current (Quiescent) | I_Q | $V_{IN}=12V$, $V_{EN}=5V$, no load without switching | 1.2 | 1.35 | 1.5 | mA |
| Supply Current (Operation) | I_{OP} | $V_{IN}=12V$, $V_{EN}=5V$, no load with switching | | 3 | 5.5 | mA |
| Supply Current (Shutdown) | I_{ST} | $V_{EN}=0V$, $V_{IN}=12V$ | | 0.01 | 0.5 | μA |
| LDO Output Voltage | V_{CC} | $V_{EN}=5V$, $7V < V_{IN} < 28V$, $0 < I_{VCC} < 10mA$ | 5.4 | 6 | 6.6 | V |
| VCC UVLO Threshold | V_{IN_UVLO} | Rising Edge | 3.6 | 4 | 4.4 | V |
| VCC UVLO Hysteresis | | | | 200 | | mV |
| EN High Voltage | V_{EN_HIGH} | V_{EN} Rising | 1.8 | | | V |
| EN Low Voltage | V_{EN_LOW} | V_{EN} Falling | | | 0.6 | V |
| STEP-UP CONVERTER | | | | | | |
| Gate Driver Impedance (Sourcing) | | $V_{CC}=6V$, $V_{GATE}=6V$ | | 4.5 | 7 | Ω |
| Gate Driver Impedance (Sinking) | | $V_{CC}=6V$, $I_{GATE}=10mA$ | | 2.5 | 5 | Ω |
| Switching Frequency | f_{SW} | $R_{OSC} = 115k\Omega$ | 459 | 540 | 621 | kHz |
| | | $R_{OSC} = 374k\Omega$ | 150 | 180 | 210 | kHz |
| OSC Voltage | V_{OSC} | | 1.20 | 1.23 | 1.26 | V |
| Maximum Duty Cycle | D_{MAX} | | | 93 | | % |
| Cycle By Cycle ISENSE Current Limit | | Max Duty Cycle | 145 | 180 | 230 | mV |
| COMP Source Current Limit | I_{COMP_SOLI} | $1V < COMP < 1.9V$ | | 70 | | μA |
| COMP Sink Current Limit | I_{COMP_SILI} | $1V < COMP < 1.9V$ | | 17 | | μA |
| COMP Trans-conductance | G_{COMP} | $\Delta I_{COMP} = \pm 10\mu A$ | | 400 | | $\mu A/V$ |
| CURRENT DIMMING | | | | | | |
| PWM Input Low Threshold | V_{PWM_LO} | V_{PWM} Falling | 0.75 | | | V |
| PWM Input High Threshold | V_{PWM_HI} | V_{PWM} Rising | | | 1.25 | V |
| Analog Dimming Input Low Threshold | Adim_L | $R_{ISET}=9.72k$ | 0.38 | 0.41 | 0.44 | V |
| Analog Dimming Input High Threshold | Adim_H | | 1.44 | 1.49 | 1.54 | V |
| LED CURRENT REGULATION | | | | | | |
| ISET Voltage | V_{ISET} | | 1.195 | 1.22 | 1.245 | V |
| LEDX Average Current | I_{LED} | $R_{ISET}=30.5k\Omega$ | 31.3 | 32.3 | 33.3 | mA |
| Current Matching ⁽⁵⁾ | | $I_{LED}=33.2mA$ | | | 2.5 | % |
| VCC Max Current Limit | Icc_Limit | | 50 | 75 | 100 | mA |
| LED FET Resistance | R_LED | $I_{LED}=10mA$ | | 1.7 | | Ω |

ELECTRICAL CHARACTERISTICS *(continued)*
 $V_{IN} = 12V$, $V_{EN} = 5V$, $T_A = 25^{\circ}C$, unless otherwise noted.

| Parameters | Symbol | Condition | Min | Typ | Max | Units |
|--|----------------|-------------------------|------|------|------|-------------|
| LEDX Regulation Voltage | V_{LEDX} | $I_{LED}=330mA$ | | 800 | | mV |
| | | $I_{LED}=60mA$ | | 285 | | mV |
| PROTECTION | | | | | | |
| OVP(Over Voltage Protection) Threshold | V_{OVP_OV} | Rising Edge | 1.20 | 1.23 | 1.26 | V |
| OVP(Over Voltage Protection) Threshold HYS | V_{OVP_HYS} | HYS | | 80 | | mV |
| OVP UVLO threshold | V_{OVP_UV} | Step-up Converter Fails | 30 | 75 | 120 | mV |
| LEDX UVLO Threshold | V_{LEDX_UV} | | 120 | 200 | 280 | mV |
| LEDX Over Voltage Threshold | V_{LEDX_OV} | | 5.8 | 6.3 | 6.8 | V |
| LED Short Fault Cycles | T_{LED_OV} | | | 4096 | | |
| Latch-Off Current Limit | V_{LMT} | | 560 | 640 | 720 | mV |
| Thermal Protection Threshold | T_{ST} | | | 150 | | $^{\circ}C$ |
| Thermal Protection Hysteresis | | | | 25 | | $^{\circ}C$ |

Notes:

5) Matching is defined as the difference of the maximum to minimum current divided by 2 times average currents.

TYPICAL CHARACTERISTICS

I_Q vs. Temperature

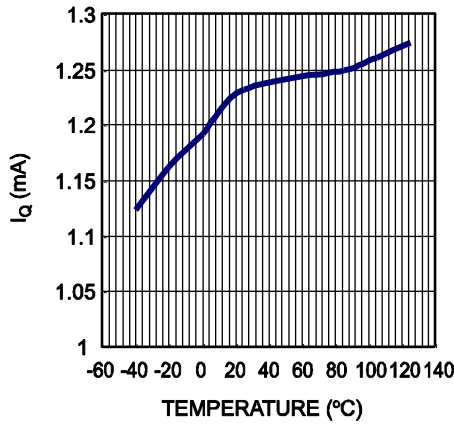

OVP Voltage vs. Temperature

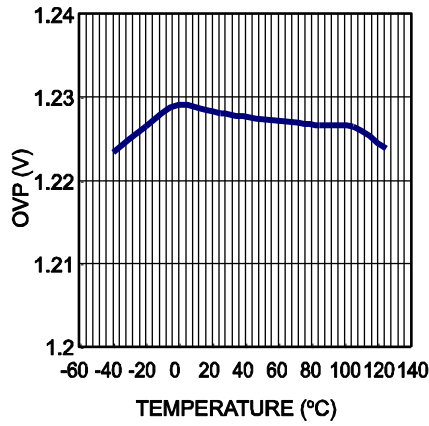

VCC UVLO vs. Temperature

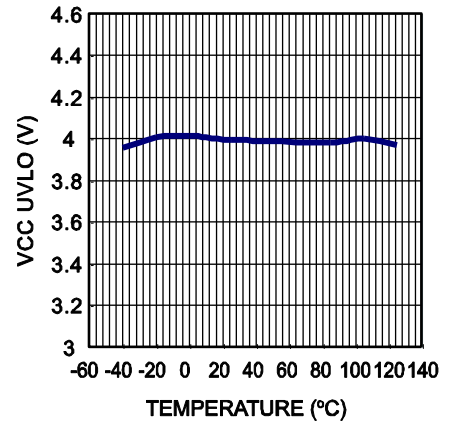

V_{adim_L} vs. Temperature

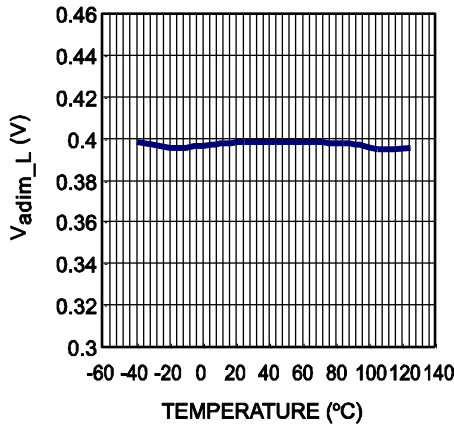

I_{LED_AVG} vs. Temperature

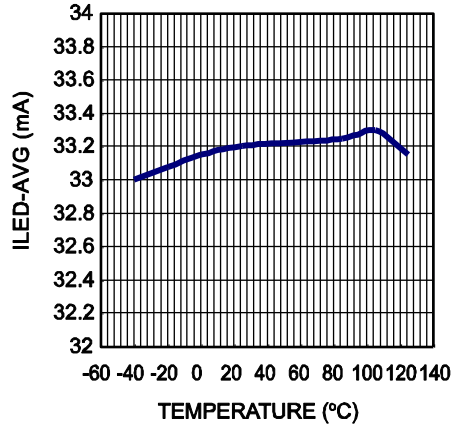

I_{LED} Matching vs. Temperature

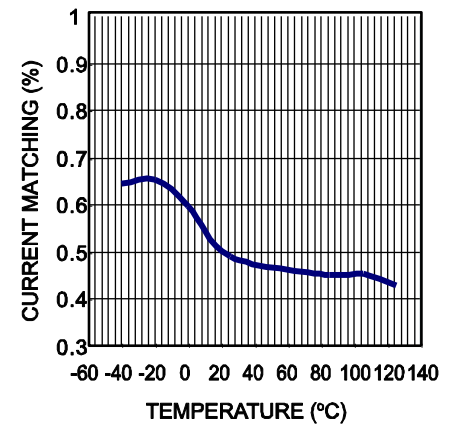

SW Frequency vs. Temperature (R_{osc}=374kΩ)

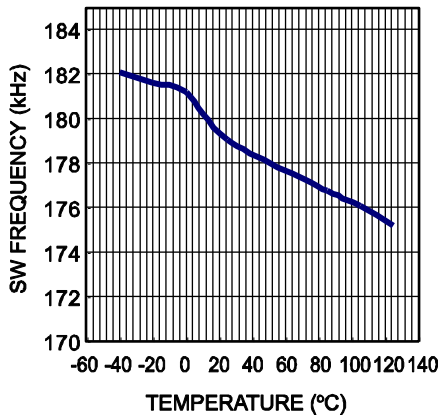

I_{SENSE_LIMIT} vs. Temperature

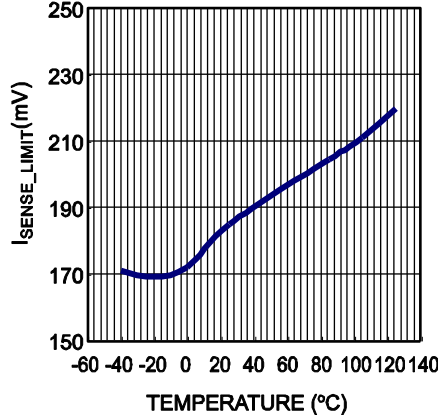

V_{LEDX} Regulation Voltage vs. Temperature

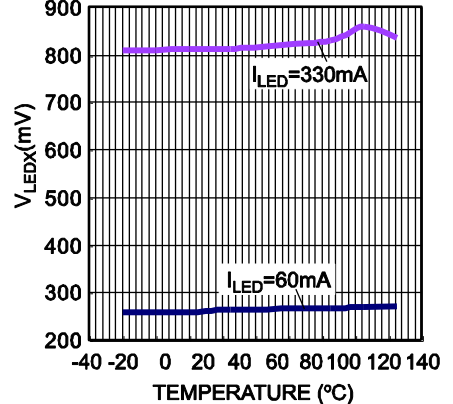

TYPICAL PERFORMANCE CHARACTERISTICS

$V_{IN} = 12V$, $V_{OUT} = 30V$, $L = 33\mu H$, $I_{LED} = 120mA/String$, 4 strings, $T_A = 25^\circ C$, unless otherwise noted.

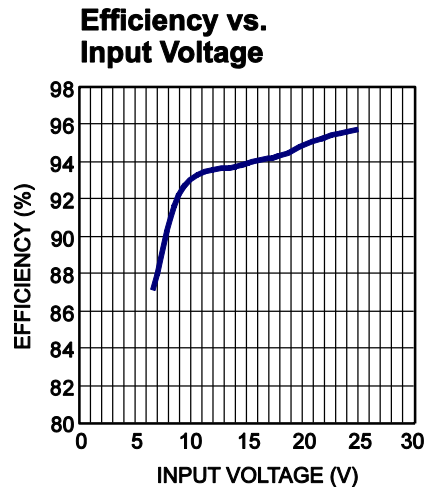

TYPICAL PERFORMANCE CHARACTERISTICS (continued)

$V_{IN} = 12V$, $V_{OUT} = 30V$, $L = 33\mu H$, $T_A = 25^\circ C$, unless otherwise noted.

Steady State

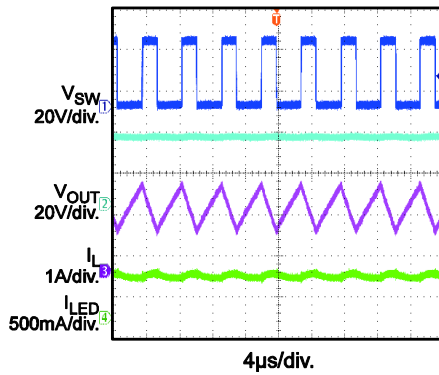

V_{IN} Power On

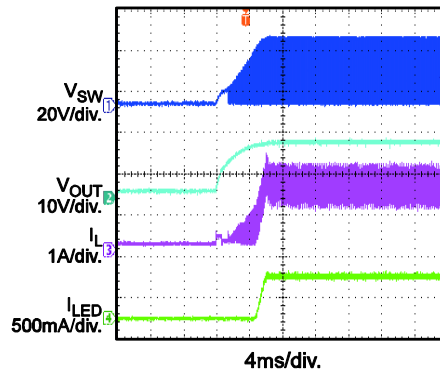

EN Power On

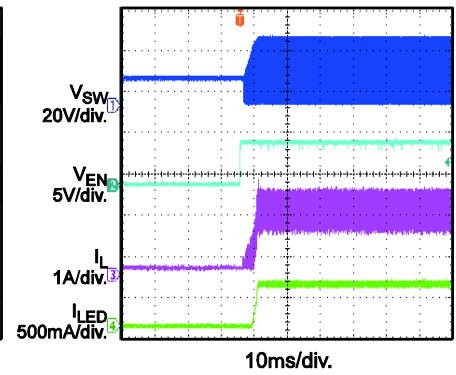

Analog Dimming

$V_{DIM} = 0.9V$

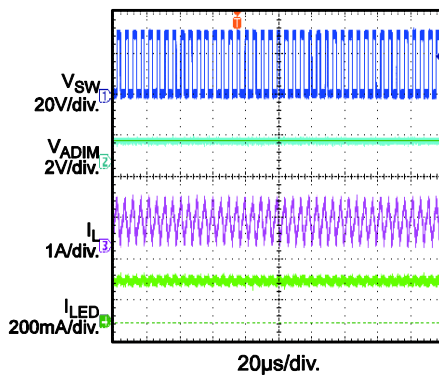

PWM Dimming

$f_{PWM} = 200Hz$, $D_{PWM} = 50\%$

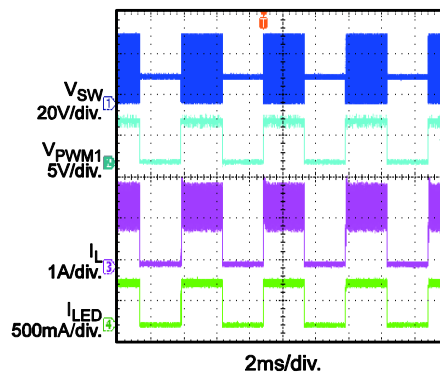

Open LED Protection

Open One LED String at Working

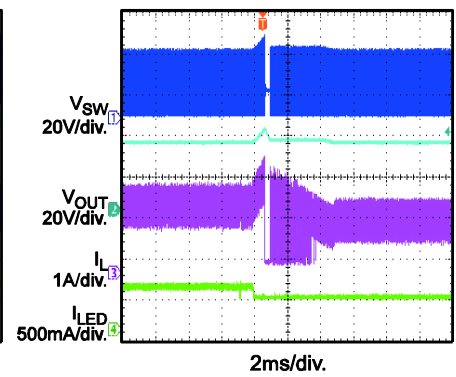

Short LED Protection

Short V_{OUT} to LEDx at Working

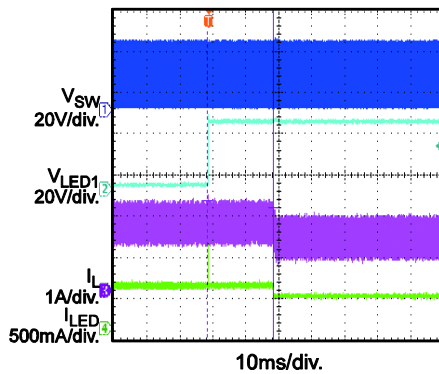

Short Inductor Protection

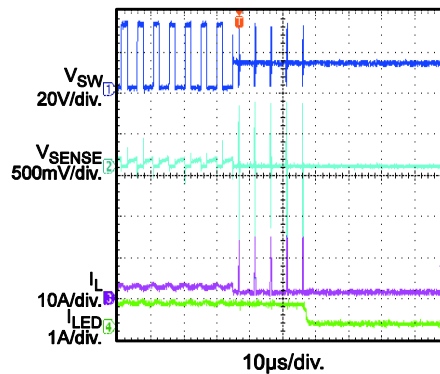

Short Diode Protection

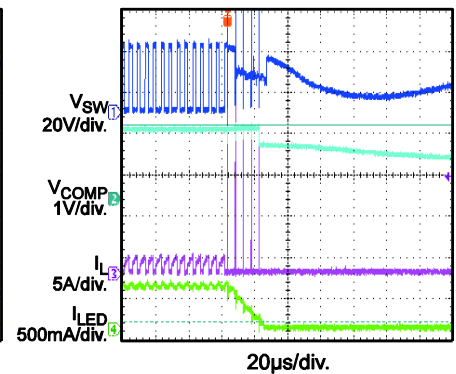

PIN FUNCTIONS

| TSSOP16-EP &SOIC16 Pin # | SOIC20 Pin # | Name | Description |
|--------------------------------|-----------------|------|---|
| 1 | 1 | COMP | Step-up Converter Compensation Pin. This pin compensates the regulation control loop. Connect a ceramic capacitor from COMP to GND. |
| 2 | 2 | EN | Enable Control Input. A voltage greater than 1.8V will turn the part on and less than 0.6 V will turn the part off. Do not let this pin float. |
| 3 | 3 | PWM | Input Signal for PWM Brightness Control. By applying a PWM signal on this pin, the LED current can be chopped and the average current is equal to $I_{set} \cdot D_{dim}$ (I_{set} is the LED current value set by a resistor connected to PIN 6; D_{dim} is the duty cycle of the PWM dimming duty cycle). Make sure the PWM amplitude voltage level $> V_{PWM_HI}$ and the low level voltage $< V_{PWM_HI}$. The input PWM signal frequency mainly determines the LED current dimming ratio. Lower dimming frequency, smaller dimming current can be gotten. In general, 200Hz to 2kHz can be used to cover most of the customers' LED current dimming requests. Internally weakly pulled to GND if this pin is floated. If PWM dimming is not required, pulling this pin to high voltage ($1.25V < V_{pwm} < 5V$). |
| 4 | 5 | GND | Ground. |
| 5 | 7 | OSC | Switching Frequency Set. Connect a resistor between OSC and GND to set the step-up converter switching frequency. The voltage at this pin is regulated to 1.23V. The clock frequency is proportional to the current sourced from this pin. |
| 6 | 8 | ISET | LED Current Set. Tie a current-setting resistor from this pin to ground to program the current in each LED string. This pin voltage is regulated to 1.225V. The LED current is proportional to the current through the ISET resistor. |
| 7 | 9 | ADIM | Signal Input for Analog Brightness Control. The LED current amplitude is determined by this pin and the input signal can be either a PWM signal or a DC voltage signal. An internal RC filter (10Mohm resistor and 100pF capacitor) is integrated to this pin. So, if a PWM signal applied to this pin, $>20kHz$ frequency is recommended to get a better PWM signal filtering performance and make sure the amplitude voltage is higher than 1.5V and low level voltage is less than 0.4V. For DC signal input, please apply a DC input signal range from 0.4V to 1.5V to linearly set the LED current from 0% to 100%. Internally weakly pulled to GND if this pin is floated. If Analog dimming is not required, pulling this pin to high voltage ($1.54V < V_{pwm} < 5V$). |
| 8 | 10 | LED4 | LED String 4 Current Input. This pin is the open-drain output of an internal dimming control switch. Connect the LED String 4 cathode to this pin. |
| 9 | 11 | LED3 | LED String 3 Current Input. This pin is the open-drain output of an internal dimming control switch. Connect the LED String 3 cathode to this pin. |
| 10 | 12 | LED2 | LED String 2 Current Input. This pin is the open-drain output of an internal dimming control switch. Connect the LED String 2 cathode to this pin. |
| 11 | 13 | LED1 | LED String 1 Current Input. This pin is the open-drain output of an internal dimming control switch. Connect the LED String 1 cathode to this pin. |
| 12 | 14 | OVP | Over-Voltage Protection Input. Connect a resistor divider from output to this pin to program the OVP threshold. When this pin voltage reaches 1.23V, the MP3398A triggers Over Voltage Protection mode. |

PIN FUNCTIONS (continued)

| TSSOP16-EP &SOIC16 Pin # | SOIC20 Pin # | Name | Description |
|--------------------------------|-----------------|--------|--|
| 13 | 17 | ISENSE | Current Sense Input. During normal operation, this pin senses the voltage across the external-inductor current-sensing resistor (R_{SENSE}) for peak-current-mode control and also to limit the inductor current during every switching cycle. If this pin is not used for cascading applications, tie this pin to GND; do not let this pin float. |
| 14 | 18 | GATE | Step-up Converter Power Switch Gate Output. This pin drives the external power N-MOS device. |
| 15 | 19 | VIN | Supply Input. VIN supplies the power to the chip, as well as the step-up converter switch. Drive VIN with a 5V to 28V power source. Must be locally bypassed. |
| 16 | 20 | VCC | The Internal 6V Linear Regulator Output. VCC provides power supply for the external MOSFET switch gate driver and the internal control circuitry. Bypass VCC to GND with a ceramic capacitor. |
| | 4, 6, 15, 16 | NC | No Connect. |

BLOCK DIAGRAM

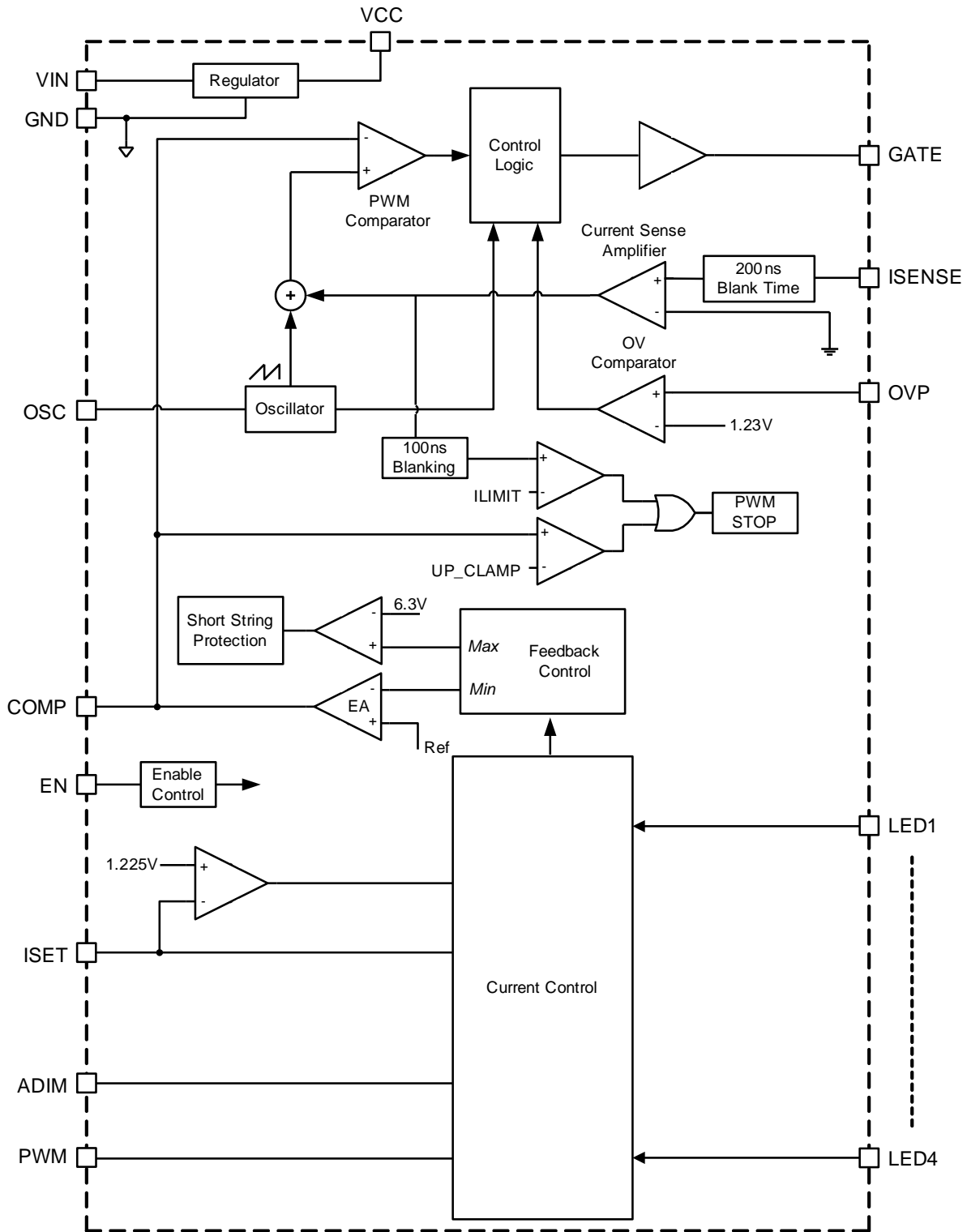

Figure 1—Functional Block Diagram

OPERATION

The MP3398A is a step-up converter with peak-current mode. It employs 4 channels of current sources to drive up to 4 strings of white LEDs.

Internal 6V Regulator

The MP3398A includes an internal linear regulator (VCC). When VIN is greater than 6.5V, this regulator outputs a 6V power supply to the external MOSFET switch gate driver and the internal control circuitry. The VCC voltage drops to 0V when the chip shuts down. The MP3398A features under-voltage lockout (UVLO). The chip is disabled until VCC exceeds the UVLO threshold. The UVLO hysteresis is approximately 200mV.

System Startup

When enabled, the MP3398A checks the topology connection first. The chip monitors the over-voltage protection (OVP) pin to see if the Schottky diode is not connected or if the boost output is shorted to GND. An OVP voltage of less than 75mV will disable the chip. The MP3398A also checks other safety limits, including UVLO and over-temperature protection (OTP), over-current protection after passing the OVP test. If all the protection tests pass, the chip then starts boosting the step-up converter with an internal soft-start.

It is recommended that the enable signal occurs after the establishment of the input voltage and PWM dimming signal during the start-up sequence to avoid large inrush current.

For better power off performance, the recommended power off sequence is as below figure shows:

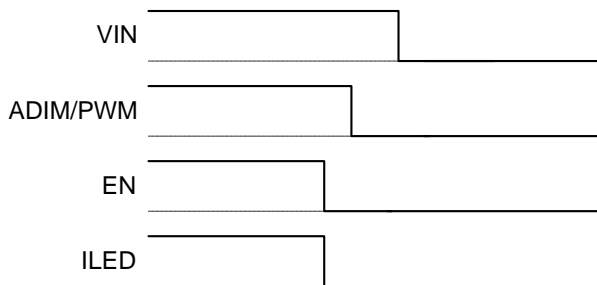

Figure 2—Power Off Sequence

The converter operating frequency is programmable (from 100kHz to 500kHz) with an external resistor connected to the OSC pin. This helps to optimize the size of external components and the efficiency.

At the beginning of each switching cycle, the internal clock turns on the external MOSFET (In normal operation, the minimum turn on time is 200ns). A stabilizing ramp added to the output of the current sense amplifier prevents sub-harmonic oscillations for duty cycles greater than 50 percent. This result is fed into the PWM comparator. When this resulting voltage reaches the output voltage of the error amplifier (V_{COMP}) the external MOSFET turns off.

The output voltage of the internal error amplifier is an amplified signal of the difference between the reference voltage and the feedback voltage. The converter automatically chooses the lowest active LEDX pin voltage to provide a high-enough bus voltage to power all the LED arrays.

If the feedback voltage drops below the reference, the output of the error amplifier increases. This results in more current flowing through the MOSFET, thus increasing the power delivered to the output. This forms a closed loop that regulates the output voltage.

Under light-load operation, especially in the case of $V_{OUT} \approx V_{IN}$, the converter runs in pulse-skipping mode where the MOSFET turns on for a minimum on-time of approximately 200ns, and then the converter discharges the power to the output for the remaining period. The external MOSFET remains off until the output voltage needs to be boosted again.

Dimming Control

The MP3398A provides two dimming methods: PWM or analog dimming mode.

For PWM dimming, apply a PWM signal to PWM pin. The LED current is chopped by this PWM signal and the average LED current is equal to $I_{set} \cdot D_{dim}$ where D_{dim} is the duty cycle of PWM dimming signal and I_{set} is the LED current amplitude.

Step-Up Converter

For analog dimming, either a PWM signal or DC signal can be applied to ADIM pin.

When a PWM signal is applied to ADIM pin, this signal will be filtered by the internal RC filter. The LED current amplitude is equal to $I_{set} \cdot D_{dim}$ where D_{dim} is the duty cycle of PWM dimming signal and I_{set} is the LED current amplitude. 20kHz or higher PWM signal is recommended to get the better filtering performance.

When a DC signal is applied to ADIM pin, the voltage range in 0.4V to 1.5V directly sets the LED current linearly from 0% to 100%.

Open String Protection

Open string protection is achieved through the OVP pin and the LED(1 to 4) pins. If one or more strings are open, the respective LEDX pins are pulled to ground and the IC keeps charging the output voltage until it reaches the over-voltage protection (OVP) threshold. If the OVP point has been triggered for $>4\mu s$, the chip stops switching and marks the strings which have an LEDX pin voltage lower than 196mV. Once marked, the remaining LED strings force the output voltage back into tight regulation. The string with the largest voltage drop determines the output regulation.

The MP3398A will always attempt to light at least one string. If all strings are open, the MP3398A shuts down the step-up converter. The strings will remain in this marked state until the chip reset.

Short String Protection

The MP3398A monitors the LEDX pin voltages to determine if a short string fault has occurred. If one or more strings are shorted, the respective LEDX pins tolerate high voltage stress. If an LEDX pin voltage is higher than 6.3V, this condition triggers the detection of a short string. When a short string faults (LEDX over-voltage fault) keeps for 4096 switching clocks, the fault string is marked OFF and disabled. Once a string is marked OFF, it disconnects from the output voltage loop. The

marked LED strings shut off completely until the part restarts. In order to prevent mis-triggering short LED protection when open LED string or sharp ADIM, the short LED protection function is disabled when V_{ledx} of all used LED channels are higher than 1.5V.

Inductor/Diode short Protection

To prevent the IC and external MOSFET damage when external inductor is shorted, MP3398A has the protection mode in two following methods. When inductor is shorted, the output can not maintain enough energy to load the LED and the output voltage will drop. Thus, the COMP (the error amplifier output) voltage tends to rise till be clamped high, when it lasts longer than 512 switching cycles the IC turns off and latches. In some cases that the COMP voltage can not be clamped to high when inductor is shorted, the IC also provides the protection mode by detecting the current flowing through power MOSFET. In this mode, when the current sense voltage across sense resistor (connected between MOSFET and GND) hits V_{LMT} limit value and lasts for 4 switching cycles, the IC turns off and latches.

Thermal Shutdown Protection

To prevent the IC operate at exceedingly high temperature, thermal shutdown is implemented in this chip by detecting the silicon die temperature. When the die temperature exceeds the upper threshold T_{ST} , the IC shutdowns and recovers to normal operation when die temperature drops below lower threshold. Typically, the hysteresis value is 25°C.

APPLICATION INFORMATION

Selecting the Switching Frequency

The switching frequency of the step-up converter is recommended from 100kHz to 500kHz for most of application. An oscillator resistor on OSC pin sets the internal oscillator frequency for the step-up converter according to the below equation:

$$F_{SW}(kHz) = \frac{67320}{R_{OSC}(k\Omega)}$$

For $R_{OSC}=374k\Omega$, the switching frequency is set to 180kHz.

Setting the LED Current

The LED each string current can be set through the current setting resistor on the ISET pin.

$$I_{LED}(mA) = \frac{810 \times 1.22V}{R_{ISET}k\Omega}$$

For $R_{SET}=8.2k\Omega$, the LED current is set to 120mA. Please do not leave ISET pin open.

Selecting the Input Capacitor

The input capacitor reduces the surge current drawn from the input supply and the switching noise from the device. The input capacitor impedance at the switching frequency should be

less than the input source impedance to prevent the high-frequency switching current from passing through to the input. Use ceramic capacitors with X5R or X7R dielectrics for their low ESR and small temperature coefficients. For most applications, use a $4.7\mu F$ ceramic capacitor in parallel with a $220\mu F$ electrolytic capacitor.

Selecting the Inductor and Current Sensing Resistor

The MP3398A requires an inductor to supply a higher output voltage while being driven by the input voltage. A larger value inductor results in less ripple current, resulting in lower peak inductor current and reducing stress on the N-channel MOSFET. However, the larger value inductor has a larger physical size, higher series resistance, and lower saturation current.

Choose an inductor that does not saturate under the worst-case load conditions. Select the minimum inductor value to ensure that the boost converter works in continuous conduction mode with high efficiency and good EMI performance. Calculate the required inductance value using the equation:

$$L \geq \frac{\eta \times V_{OUT} \times D \times (1-D)^2}{2 \times f_{SW} \times I_{LOAD}}$$

$$D = 1 - \frac{V_{IN}}{V_{OUT}}$$

Where V_{IN} and V_{OUT} are the input and output voltages, f_{SW} is the switching frequency, I_{LOAD} is the LED load current, and η is the efficiency.

The switching current is usually used for the peak current mode control. In order to avoid hitting the current limit, the voltage across the sensing resistor R_{SENSE} must measure less than 80% of the worst-case current-limit voltage, V_{SENSE} .

$$R_{SENSE} = \frac{0.8 \times V_{SENSE}}{I_{L(PEAK)}}$$

$$I_{L(PEAK)} = \frac{V_{OUT} \times I_{LOAD}}{\eta V_{IN}} + \frac{V_{IN} \times (V_{OUT} - V_{IN})}{2 \times L \times f_{SW} \times V_{OUT}}$$

Where $I_{L(PEAK)}$ is the peak value of the inductor current. V_{SENSE} is shown in Figure 3.

Vsense vs. Duty Cycle

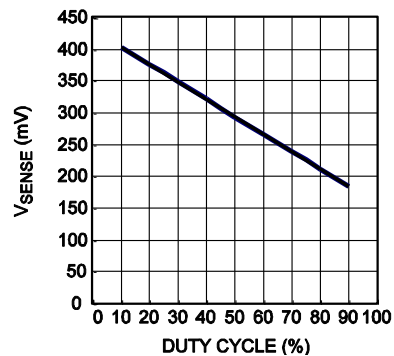

Figure 3— V_{SENSE} vs Duty Cycle

Selecting the Power MOSFET

The MP3398A is capable of driving a wide variety of N-channel power MOSFETS. The critical parameters of selection of a MOSFET are:

1. Maximum drain-to-source voltage, $V_{DS(MAX)}$
2. Maximum current, $I_{D(MAX)}$
3. On-resistance, $R_{DS(ON)}$
4. Gate source charge Q_{GS} and gate drain charge Q_{GD}
5. Total gate charge, Q_G

Ideally, the off-state voltage across the MOSFET is equal to the output voltage. Considering the voltage spike when it turns off, $V_{DS(MAX)}$ should be greater than 1.5 times of the output voltage.

The maximum current through the power MOSFET occurs at the minimum input voltage and the maximum output power. The maximum RMS current through the MOSFET is given by

$$I_{RMS(MAX)} = I_{IN(MAX)} \times \sqrt{D_{MAX}}, \text{ where:}$$

$$D_{MAX} \approx \frac{V_{OUT} - V_{IN(MIN)}}{V_{OUT}}$$

The current rating of the MOSFET should be greater than $1.5 \times I_{RMS}$

The ON resistance of the MOSFET determines the conduction loss, which is given by:

$$P_{cond} = I_{RMS}^2 \times R_{DS(on)} \times k$$

Where k is the temperature coefficient of the MOSFET.

The switching loss is related to Q_{GD} and Q_{GS1} which determine the commutation time. Q_{GS1} is the charge between the threshold voltage and the plateau voltage when a driver charges the gate, which can be read in the chart of V_{GS} vs. Q_G of the MOSFET datasheet. Q_{GD} is the charge during the plateau voltage. These two parameters are needed to estimate the turn-on and turn-off losses.

$$P_{SW} = \frac{Q_{GS1} \times R_G}{V_{DR} - V_{TH}} \times V_{DS} \times I_{IN} \times f_{SW} + \frac{Q_{GD} \times R_G}{V_{DR} - V_{PLT}} \times V_{DS} \times I_{IN} \times f_{SW}$$

Where V_{TH} is the threshold voltage, V_{PLT} is the plateau voltage, R_G is the gate resistance, and

V_{DS} is the drain-source voltage. Please note that calculating the switching loss is the most difficult part in the loss estimation. The formula above provides a simplified equation. For more accurate estimates, the equation becomes much more complex.

The total gate charge, Q_G , is used to calculate the gate drive loss. The expression is

$$P_{DR} = Q_G \times V_{DR} \times f_{SW}$$

Where V_{DR} is the drive voltage.

Selecting the Output Capacitor

The output capacitor keeps the output voltage ripple small and ensures feedback loop stability. The output capacitor impedance must be low at the switching frequency. Ceramic capacitors with X7R dielectrics are recommended for their low ESR characteristics. For most applications, a 4.7 μ F ceramic capacitor in parallel with a 22 μ F electrolytic capacitor will suffice.

Setting the Over Voltage Protection

The open string protection is achieved through the detection of the voltage on the OVP pin. In some cases, an LED string failure results in the feedback voltage always zero. The part then keeps boosting the output voltage higher and higher. If the output voltage reaches the programmed OVP threshold, the protection will be triggered.

To ensure the chip functions properly, select the resistor values for the OVP resistor divider to provide an appropriate set voltage. The recommended OVP point is about 1.1 to 1.2 times higher than the output voltage for normal operation.

$$V_{OVP} = 1.23 \times \left(1 + \frac{R_{HIGH}}{R_{LOW}}\right)$$

Selecting Dimming Control Mode

The MP3398A provides two different dimming methods.

1. Direct PWM Dimming

An external PWM dimming signal is employed to achieve PWM dimming control. Apply a PWM dimming signal (in the range of 100Hz to 20kHz) to the PWM pin. The minimum recommended

amplitude of the PWM signal is 1.5V and the low level should be less than 0.4V.

Table 1—The Range of PWM Dimming Duty

| $f_{PWM}(Hz)$ | D_{min} | D_{max} |
|--------------------|-----------|-----------|
| $100 < f \leq 200$ | 0.30% | 100% |
| $200 < f \leq 500$ | 0.75% | 100% |
| $500 < f \leq 1k$ | 1.50% | 100% |
| $1k < f \leq 2k$ | 3.00% | 100% |
| $2k < f \leq 5k$ | 7.50% | 100% |
| $5k < f \leq 10k$ | 15.00% | 100% |
| $10k < f \leq 20k$ | 30.00% | 100% |

2. Analog Dimming

For analog dimming, apply a PWM signal or a DC voltage signal to ADIM pin. An internal RC filter (10Mohm resistor and 100pF capacitor) is integrated to this pin. So, if a PWM signal applied to this pin, >20kHz frequency is recommended to get a better PWM signal filtering performance and make sure the amplitude voltage is higher than 1.5V and low level voltage is less than 0.4V with >15mV/ns slope rate for falling/rising edge. For DC signal input, please apply a DC input signal range from 0.4V to 1.5V to linearly set the LED current from 0% to 100%.

Expanding LED Channels

The MP3398A can expand the number of LED channels by using two or three MP3398A in parallel. To connect two MP3398A for a total of 8 LED strings, tie the VCC pins of the master IC and the slave IC together to power the slave IC internal logic circuitry. Tie the COMP pins of the slave IC and the master IC together to regulate the voltage of all 8 strings LEDs. The slave IC

MOSFET driving signals are not used; the boost converter can be only driven by the master IC. Do not leave the I_{SENSE} pin of the slave IC floating; tie it to ground. Apply the EN and DIM signals to both ICs.

Layout Considerations

The circuit layout for the MP3398A requires special attention to reduce EMI noise.

The loop from the external MOSFET (M1), through the output diode (D1) and the output capacitor (C2, C3) carry a high-frequency pulse current and must be as small and short as possible (See Figure 4).

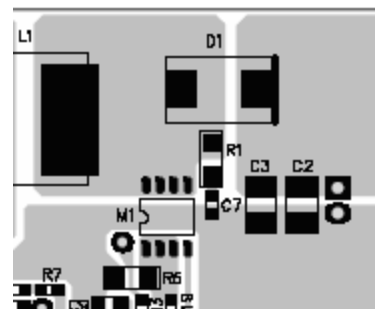

Figure 4—Layout Consideration

All logic signals refer to the signal ground. in order to reduce the noise affection, it is recommend to separate the power ground(PGND) and signal ground(GND), then connect PGND and GND together.

TYPICAL APPLICATION CIRCUITS

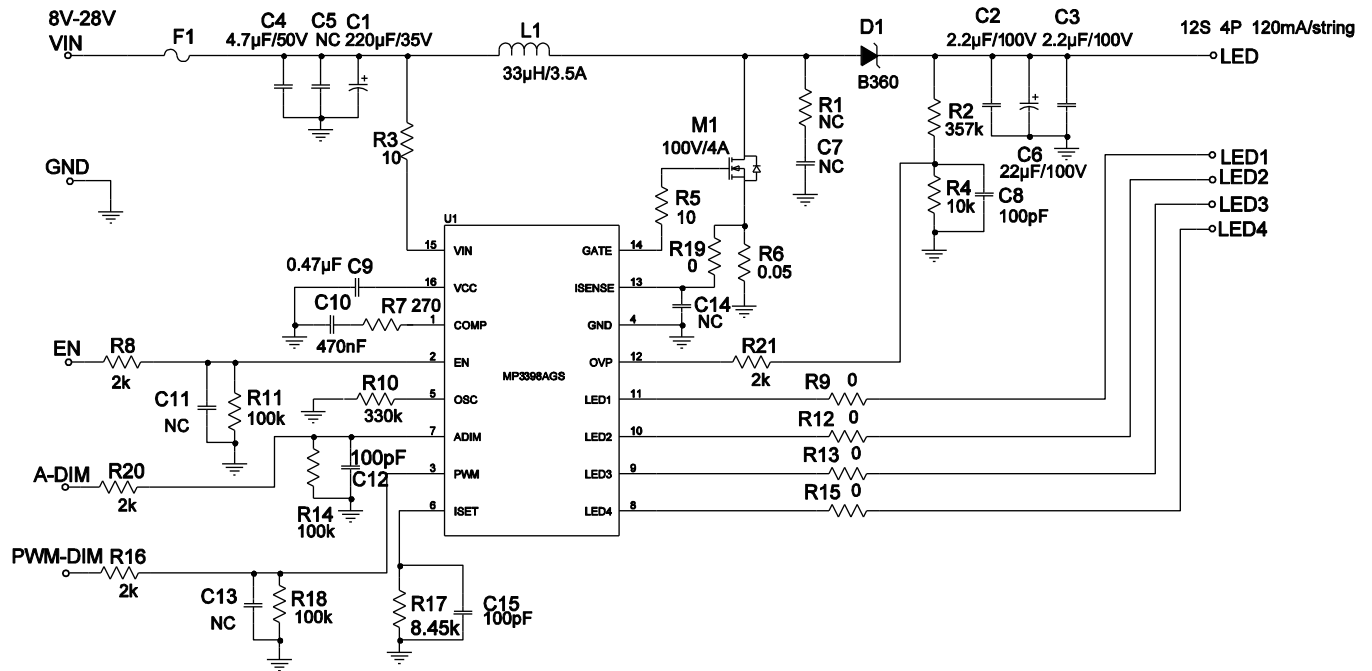
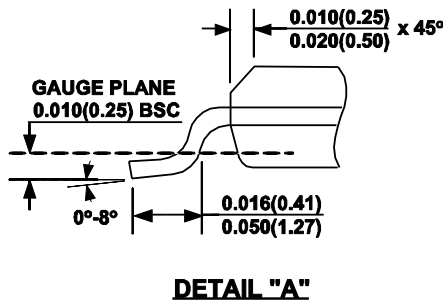
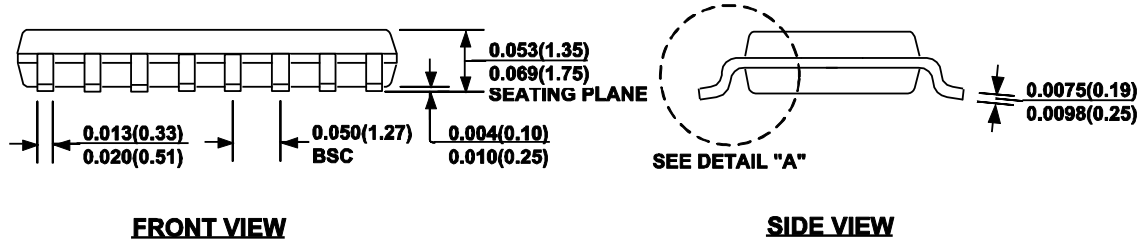
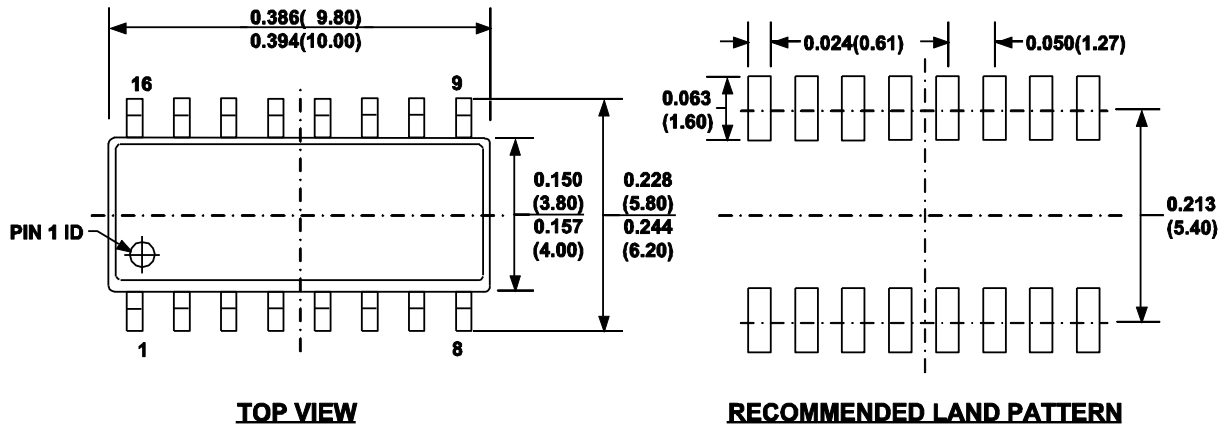

Figure 5: 4 string, 12 LED in series, 120mA/string application
 (Some components are reasonably adjustable based on real case)

PACKAGE INFORMATION

SOIC16



NOTE:

- 1) CONTROL DIMENSION IS IN INCHES. DIMENSION IN BRACKET IS IN MILLIMETERS.
- 2) PACKAGE LENGTH DOES NOT INCLUDE MOLD FLASH, PROTRUSIONS OR GATE BURRS.
- 3) PACKAGE WIDTH DOES NOT INCLUDE INTERLEAD FLASH OR PROTRUSIONS.
- 4) LEAD COPLANARITY (BOTTOM OF LEADS AFTER FORMING) SHALL BE 0.004" INCHES MAX.
- 5) DRAWING CONFORMS TO JEDEC MS-012, VARIATION AC.
- 6) DRAWING IS NOT TO SCALE.

TSSOP16-EP (with external thermal pad)

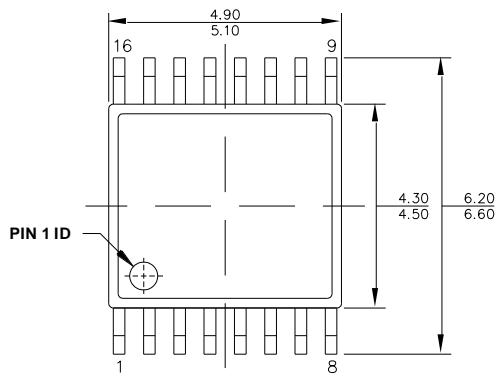

TOP VIEW

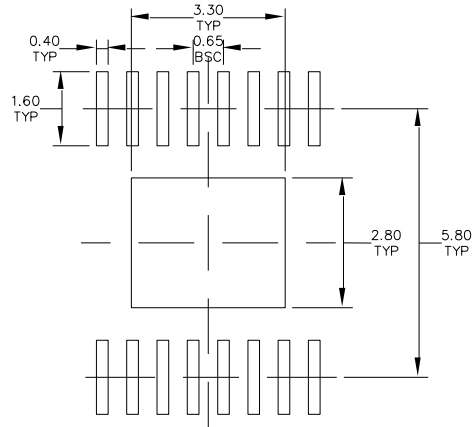

RECOMMENDED LAND PATTERN

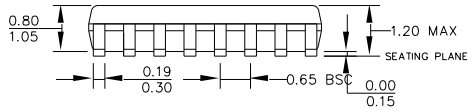

FRONT VIEW

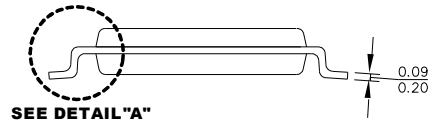

SEE DETAIL "A"

SIDE VIEW

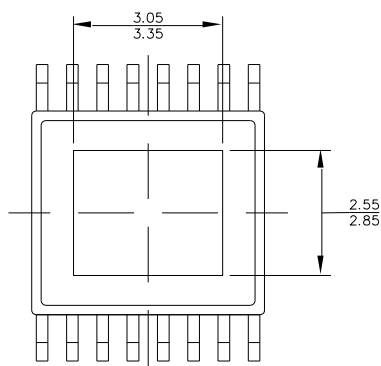

BOTTOM VIEW

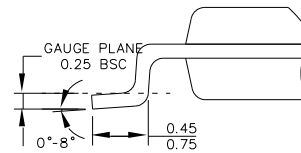

DETAIL "A"

NOTE:

- 1) ALL DIMENSIONS ARE IN MILLIMETERS
- 2) PACKAGE LENGTH DOES NOT INCLUDE MOLD FLASH, PROTRUSION OR GATE BURR.
- 3) PACKAGE WIDTH DOES NOT INCLUDE INTERLEAD FLASH OR PROTRUSION.
- 4) LEAD COPLANARITY (BOTTOM OF LEADS AFTER FORMING) SHALL BE 0.10 MILLIMETERS MAX
- 5) DRAWING CONFORMS TO JEDEC MO-153, VARIATION ABT.
- 6) DRAWING IS NOT TO SCALE

SOIC20

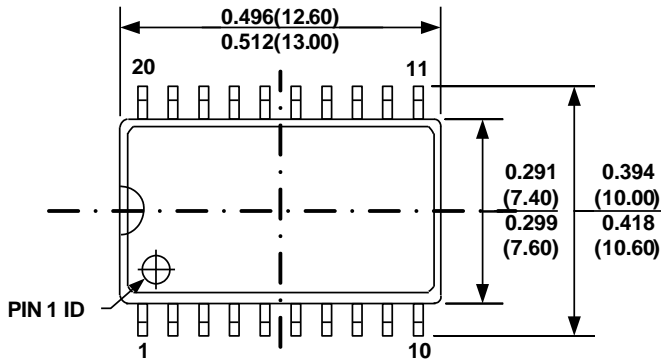

TOP VIEW

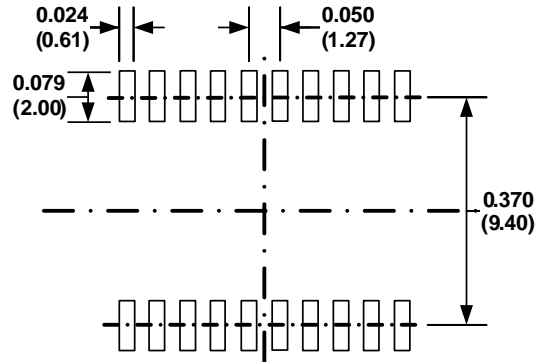

RECOMMENDED LAND PATTERN

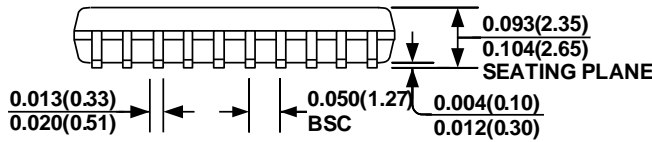

FRONT VIEW

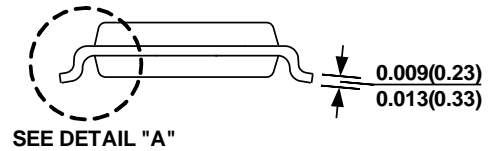

SIDE VIEW

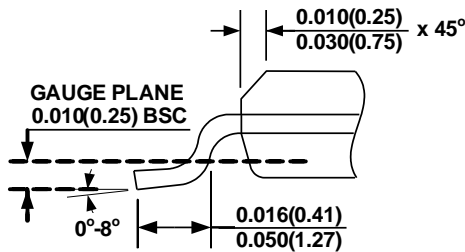

DETAIL "A"

NOTE:

- 1) CONTROL DIMENSION IS IN INCHES DIMENSION IN BRACKET IS IN MILLIMETERS
- 2) PACKAGE LENGTH DOES NOT INCLUDE MOLD FLASH, PROTRUSIONS OR GATE BURRS
- 3) PACKAGE WIDTH DOES NOT INCLUDE INTERLEAD FLASH OR PROTRUSIONS.
- 4) LEAD COPLANARITY(BOTTOM OF LEADS AFTER FORMING) SHALL BE 0.10 MILLIMETERS MAX
- 5) DRAWING CONFORMS TO JEDEC MS013, VARIATION AC.
- 6) DRAWING IS NOT TO SCALE

NOTICE: The information in this document is subject to change without notice. Please contact MPS for current specifications. Users should warrant and guarantee that third party Intellectual Property rights are not infringed upon when integrating MPS products into any application. MPS will not assume any legal responsibility for any said applications.