

DESCRIPTION

The MP26058 is a linear, high performance single cell Li-Ion or Li-Polymer battery charger. By integrating high voltage input protection into the charger IC, the MP26058 can tolerate an input surge up to 28V. The LDO mode makes the MP26058 suitable for power up the system when battery is not present.

The device features constant current (CC) and constant voltage (CV) charging modes with programmable charge currents (200mA to 1A), current blocking. The other features include the programmable battery full indication threshold and the LDO mode operation which keeps charging the battery after battery-full is asserted and stay in full-state as long as the valid input is maintained. MP26058 can provide load to the system if no battery is connected.

For guaranteed safe operation, the MP26058 limits the die temperature to a preset value when the device is heated up due to limited PCB space. Other safety features are battery temperature monitoring, and programmable timer to prevent prolonged charging a dead battery.

MP26058 is available in 10-pin 3mm x 3mm DFN packages.

FEATURES

- Complete Solution for Charging Single-Cell Li-Ion Battery
- Input Surge Up to 28V
- Wide input operating range 2.8V – 7V
- Adapter or USB Input
- Programmable Charge Current: 200mA to 1A
- Programmable timer
- 7V Input Over Voltage Protection
- 0.75% V_{BATT} Accuracy over Temperature
- $<1\mu A$ Battery Reverse Current
- 125 μA Standby Current from V_{IN}
- Battery Temperature Monitoring
- Automatic die temperature limiting
- Fault and Charge Status Indicators
- Soft-Start to limit inrush current
- Tiny 3mm x 3mm QFN Package

APPLICATIONS

- Cell Phones
- Digital Cameras
- Smart Phones
- PDAs
- MP3 Players

"MPS" and "The Future of Analog IC Technology" are Registered Trademarks of Monolithic Power Systems, Inc.

TYPICAL APPLICATION

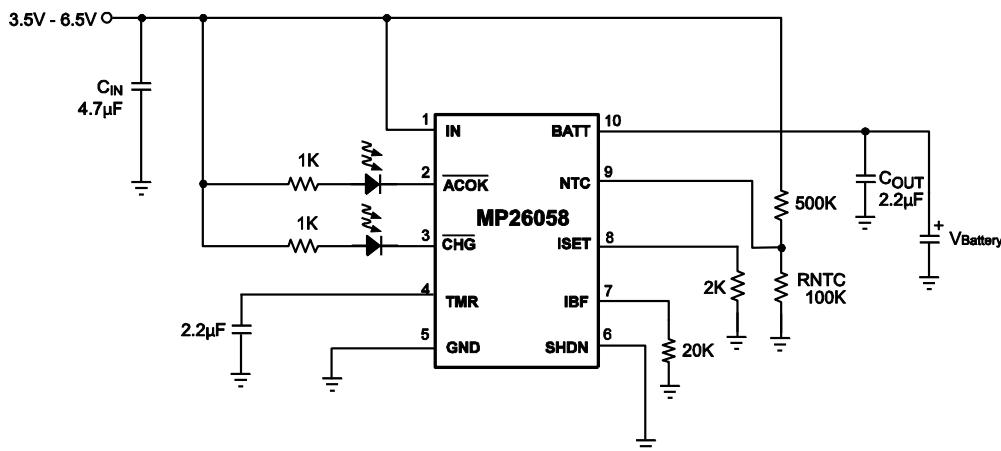

PACKAGE REFERENCE

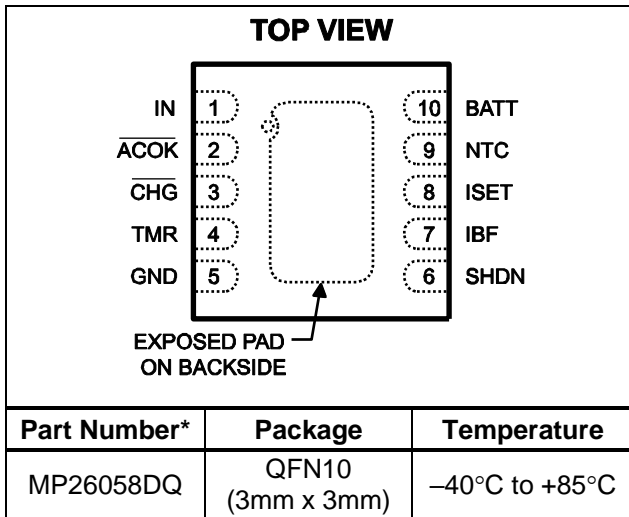

* For Tape & Reel, add suffix -Z (eg. MP26058DQ-Z)
 For RoHS compliant packaging, add suffix -LF
 (eg. MP26058DQ-LF-Z)

ABSOLUTE MAXIMUM RATINGS ⁽¹⁾

IN to GND -0.3V to +28V
 All Other Pins to GND..... -0.3V to +6.5V
 \overline{ACOK} & \overline{CHG} Maximum Sink Current...20mA
 Junction Temperature..... 140°C
 Lead Temperature260°C
 Storage Temperature-65°C to +150°C

Recommended Operating Conditions ⁽²⁾

Nominal Supply Voltage V_{IN} 3.5V to 5.5V
 Operating Temperature-40°C to +85°C

Thermal Resistance ⁽³⁾ θ_{JA} θ_{JC}

3x3 QFN10 50..... 12... °C/W

Notes:

- 1) Exceeding these ratings may damage the device.
- 2) The device is not guaranteed to function outside of its operating conditions.
- 3) Measured on JEDEC51-7 4 layer board..

ELECTRICAL CHARACTERISTICS

$V_{IN} = 5V$, $V_{SHDN} = 0V$, $T_A = +25^\circ C$, unless otherwise noted.

Parameter	Symbol	Condition	Min	Typ	Max	Units
Supply Current	I_{SUPPLY}	SHDN = High		30		μA
		SHDN = Low, $I_{CHG} = 0A$		500		
Battery Voltage Regulation	V_{BATT}	$T = -5^\circ C$ to $+75^\circ C$, $I_{BATT} = 0A$	4.16	4.20	4.24	V
Constant Current Regulation	I_{CHG}	$V_{IN} = 5V$, $V_{BATT} = 3.8V$ $R_{CHG} = 3.3k\Omega$	448	515	582	mA
Constant Current Variation		$V_{IN} = 5V$, $V_{BATT} = 3.8V$, $T_J = 0^\circ C$ to $+120^\circ C$, $R_{CHG} = 1.6k\Omega$ to $8.0k\Omega$	87	100	113	% I_{CHG} (4)
Battery Full Programming Range	I_{BF}	Refer to Operation section for programming I_{BF}	10		50	% I_{CHG} (4)
IBF Accuracy			75		125	% I_{BF} (5)
Input OVP		V_{IN} Rising	6.7	7	7.3	V
OVP Hysteresis				400		mV
Input UVLO		V_{IN} Rising	1.6	2.2	2.8	V
UVLO Hysteresis				100		mV
Input \overline{ACOK} Up Range			6.7	7	7.2	V
\overline{ACOK} & \overline{CHG} Over Voltage Clamp	V_Z			7.6		V

ELECTRICAL CHARACTERISTICS *(continued)*
 $V_{IN} = 5V$, $V_{SHDN} = 0V$, $T_A = +25^{\circ}C$, unless otherwise noted.

Parameter	Symbol	Condition	Min	Typ	Max	Units
SHDN Trip Threshold High			2.6			V
SHDN Trip Threshold Low					0.4	V
\overline{CHG} , \overline{ACOK} Sink Current		Pin Voltage = 0.2V	5			mA
Battery Reverse Current to BATT Pin		SHDN = Low and Input = Floating or 0V			1	μA
Dropout Voltage	V_{IN} - V_{BATT}	$V_{BATT} = 3.8V$, $R_{CHG} = 6k\Omega$. Current drop 10%		0.25		V
Soft Thermal Shutdown Threshold			105	120	135	$^{\circ}C$
Soft Thermal Shutdown Hysteresis				10		$^{\circ}C$
Internal Soft-Start Time		From 10% to 90% of full current		20		μs
R_NTC at 0 $^{\circ}C$	TH11-4H104F	Note: R_NTC is 100k at 25 $^{\circ}C$		376.6		k Ω
R_NTC at 50 $^{\circ}C$	TH11-4H104F	Note: R_NTC is 100k at 25 $^{\circ}C$		32.3		k Ω
Oscillation Freq		$C_{TMR} = 2.2\mu F$		5		Hz
TMR Pin Source Current	I_{TMR1}	$V_{TMR} = 0.1V$	18	20	22	μA
TMR Pin Sink Current	I_{TMR2}	$V_{TMR} = 1.5V$	18	20	22	μA

Notes:

- 4) I_{CHG} is the target preprogrammed charge current (Die temperature below 110 $^{\circ}C$).
- 5) I_{BF} is the target preprogrammed battery full current threshold.

PIN FUNCTIONS

Pin #	Name	Description
1	IN	Input Supply Pin. IN receives the AC adapter or USB supply voltage.
3	$\overline{\text{CHG}}$	Open-Drain Charge Indicator. This pin is low during charging, is High after battery full or termination, is toggling the battery is fault.
2	$\overline{\text{ACOK}}$	Open-Drain Fault Status Indicator.
4	TMR	Oscillator Period Timer. Connect a timing capacitor between this pin and GND to set the oscillator period. $T(\text{sec})=22000 * C_{\text{TMR}} (\mu\text{F})$. Short this pin to ground to disable timer.
5	GND, Exposed Pad	The exposed pad and GND pin must be connected to the same ground plane.
6	SHDN	Charger IC Enable. An input “Low” signal at this pin or if the pin is floating will enable the IC.
8	ISET	Constant Charge Current Program pin. Connect this pin to an external resistor to program the charging current in CC Mode.
7	IBF	Charge Status Threshold Program. Connect this pin to an external resistor to program the charge termination current or battery full indication threshold.
9	NTC	Negative Temperature Coefficient (NTC) Thermistor Pin. Connect a 500k Ω resistor from this pin to the IN pin and a 100k Ω NTC resistor (within the battery pack) from this pin to ground. If NTC function is not used, replace NTC resistor with a regular 100k Ω resistor from this pin to ground. Do not leave this pin floating.
10	BATT	Charger Output.

TYPICAL PERFORMANCE CHARACTERISTICS

$C_{IN}=4.7\mu F$, $C_{OUT}=2.2\mu F$, $V_{IN}=5V$, $T_A=25^\circ C$, unless otherwise noted.

Battery Charge Curve

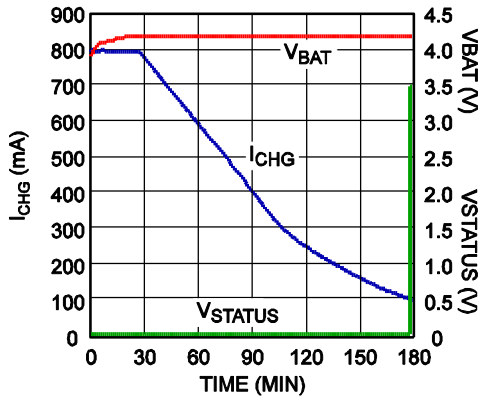

Charge Current vs. Battery Voltage

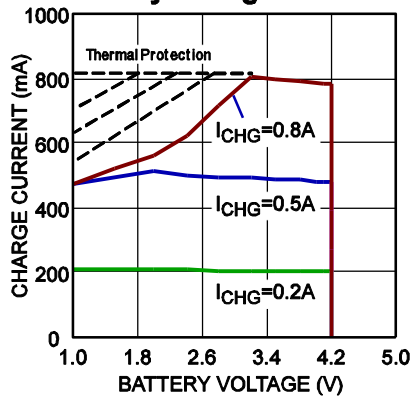

Constant Current Charge vs. Input Voltage

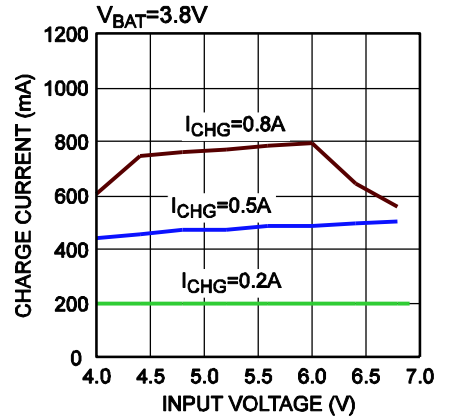

Constant Voltage Charge

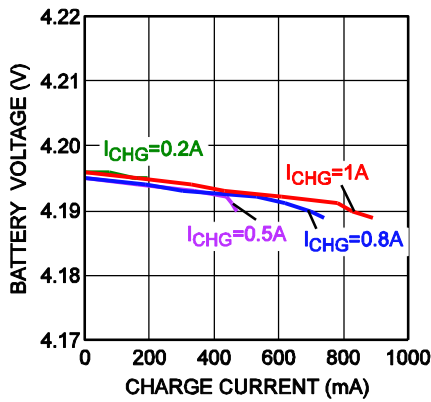

R_{CHG} Resistance vs. I_{CHG}

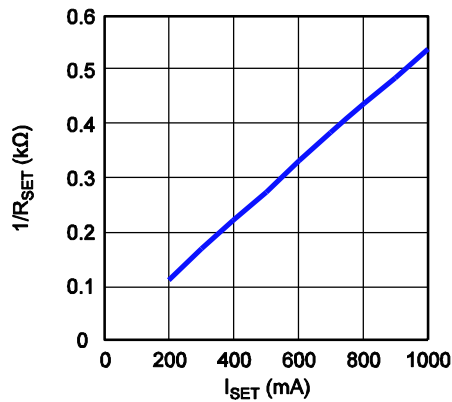

Thermal Protection

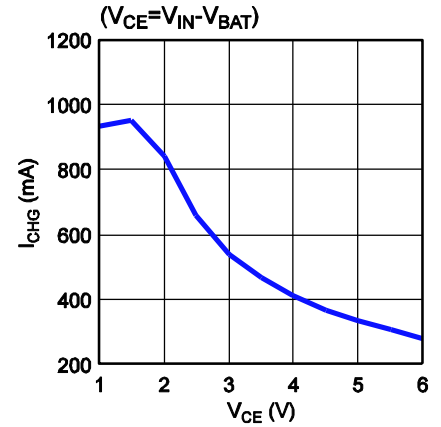

TYPICAL PERFORMANCE CHARACTERISTICS

$C_{IN}=4.7\mu F$, $C_{OUT}=2.2\mu F$, $V_{IN}=5V$, $T_a=25^\circ C$, unless otherwise noted. (continued)

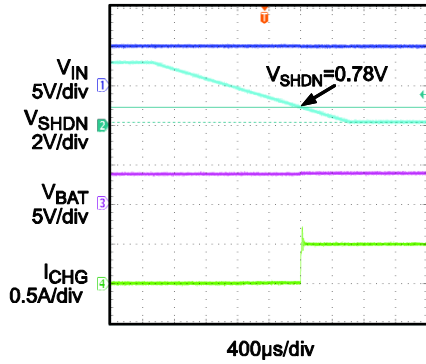
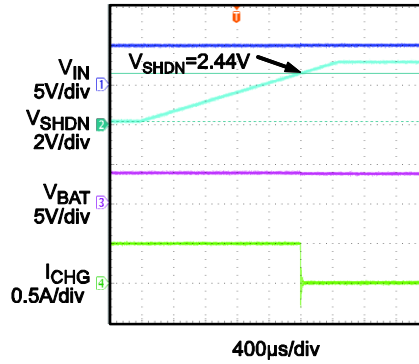
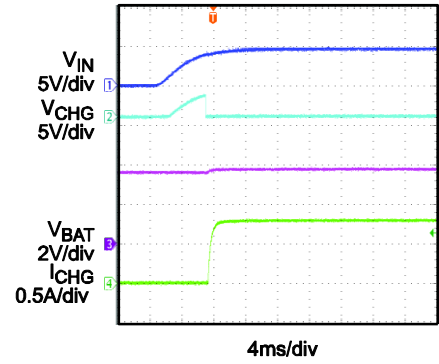
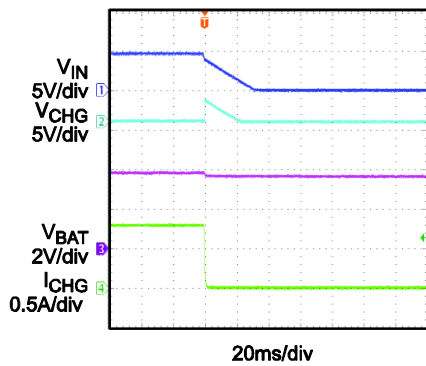
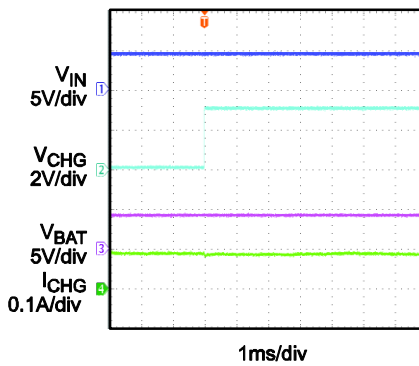
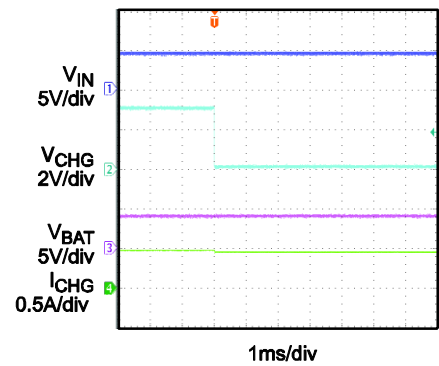
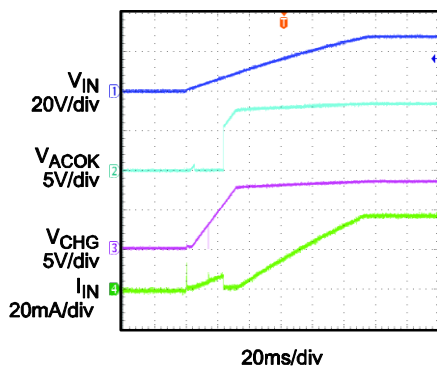
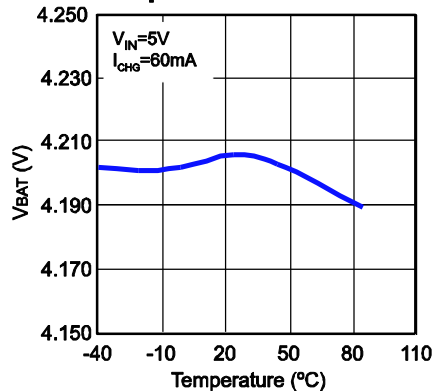
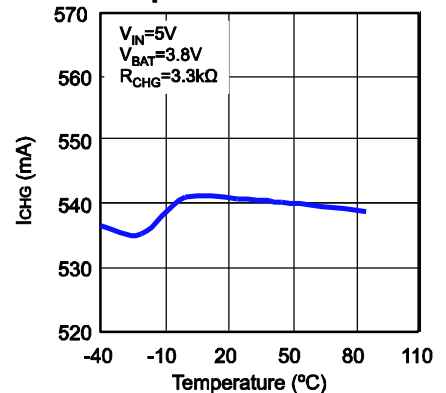
Shut Down Low
 $R_{CHG}=3.6k\Omega$

Shut Down High
 $R_{CHG}=3.6k\Omega$

Power Ramp Up
 $R_{CHG}=2.26k\Omega$

Power Ramp Down
 $R_{CHG}=2.26k\Omega$

Charge Full Terminated
 $V_{IN}=4.5V$, $R_{CHG}=3.6k\Omega$

Terminated to Re-Charge
 $V_{IN}=4.5V$, $R_{CHG}=3.6k\Omega$

Maximum Input Voltage

Voltage Charge vs. Temperature

Current Charge vs. Temperature

BLOCK DIAGRAM

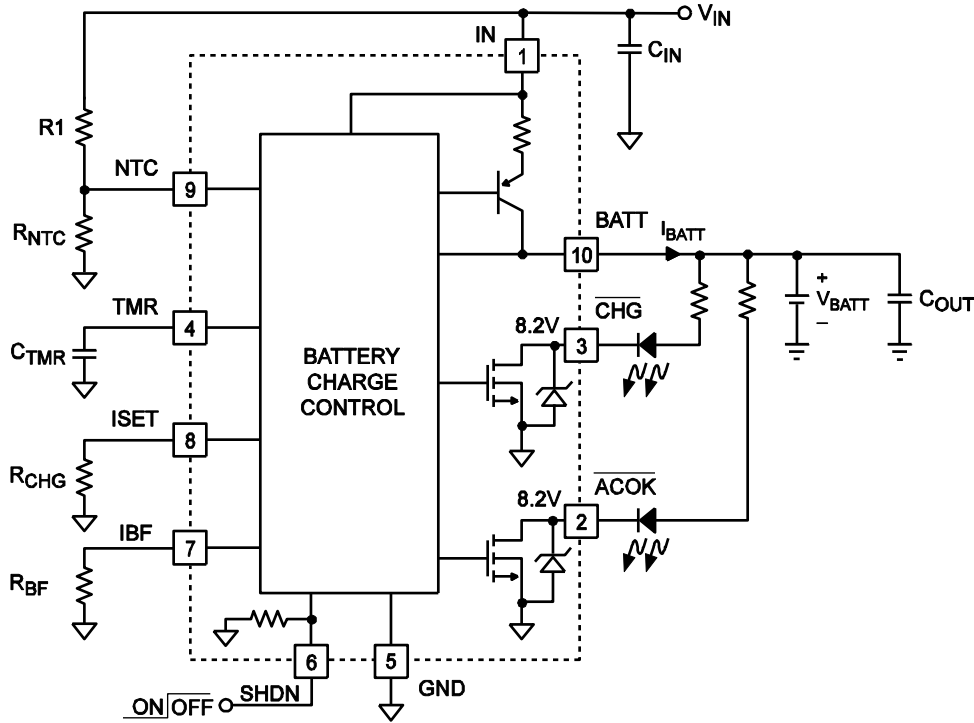

Figure 1—Functional Block Diagram

OPERATION

Input Voltage Range

The MP26058 has built-in input voltage surge protection as high as +28V. The charger IC will be automatically disabled when the input voltage is lower than 2.2V or higher than 7.0V. For MP26058, the open-drain pin \overline{ACOK} is used to indicate an input power good condition (i.e. $2.8V < V_{IN} < 7.0V$). If the input voltage is lower than the battery voltage, the IC is also disabled to prevent the battery from draining.

Charge Cycle (Mode Change: CC-> LDO)

Figure 2 below shows the typical charging profile for the MP26058. It begins charging at the constant current of the programmed value (I_{CHG}). This is referred to as Constant Current (CC) mode. Once the battery voltage reaches 4.2V, the charger will operate in the LDO mode to keep the battery is fully charged. The charge current drops during LDO mode, and the battery full indication is set when the charge current reduced to the preset value based on R_{BF} . After 262144 cycles of continuous

charging, if the battery is still not reaching I_{BF} condition, the on-chip timer will terminate the charger to prevent charging the dead battery for excessive long time and the fault condition will be flagged by flashing the \overline{CHG} LED.

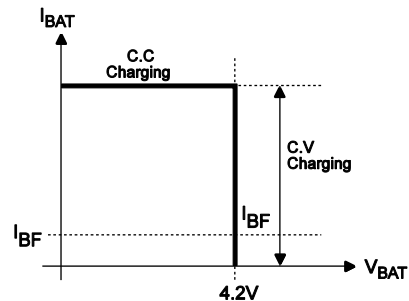

Figure 2—MP26058 Typical Charging Profile

Programming of Charge Current and Battery Full Current

The charge current (I_{CHG}) is set by a resistor (R_{CHG}) connecting from the ISET pin to GND. The relationship of the charge current and the programming resistance is established by the following table and graph.

Table 1— R_{CHG} and I_{CHG} Relationship

R_{CHG} (k Ω)	I_{CHG} (mA)
1.65	1000
1.82	900
2.05	800
2.32	700
2.74	600
3.3	500
4.12	400
5.6	300
8.66	200
16.9	100

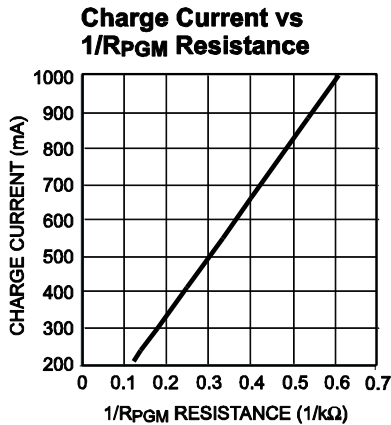

Figure 3—Charge Current vs $1/R_{CHG}$ Resistance

The recommended resistance for programming the charge current is $2.3k\Omega < R_{CHG} < 11k\Omega$. The battery full charge current threshold (I_{BF}) is programmed by connecting a resistor R_{BF} from the IBF pin to GND:

$$I_{BF} = \frac{1A \times 1.7k\Omega}{R_{BF}}$$

Where $2R_{CHG} < R_{BF} < 10R_{CHG}$. The open-drain pin \overline{CHG} is used to indicate charging status. When the battery full condition is reached or any other condition prevents the charger from charging, \overline{CHG} will become a floating.

Timer Operation

The TMR pin is used to set the internal oscillator frequency: $F_{OSC} = 11Hz \times \frac{\mu F}{C_{TMR}}$

The on-chip timer will start count down after initial power-up or every time being enabled. This timer will limit the max charge time when battery is short to ground to 16384 internal oscillating cycles, or if the total charge time exceeds 262144 cycles and the battery full has not been qualified, then it will terminate the charger and a fault will be set by flashing \overline{CHG} LED at the rate of half the internal oscillation frequency.. After fault reporting, the charger can be re-initiated only by recycling the power supply or SHDN\ signal. The timer function can be disabled by shorting TMR pin to ground.

Negative Thermal Coefficient (NTC)

Thermistor

The MP26058 has a built-in NTC resistance window comparator. If configured as the typical application circuit as indicated in Figure 1, the MP26058 will cease charging if $R_{NTC} < 32.3k\Omega$ or $R_{NTC} > 376.6k\Omega$. This represents a valid charging temperature range of $0^{\circ}C$ to $50^{\circ}C$ for the TH11-4H104F NTC resistor.

Thermal Protection

The MP26058 has proprietary thermal protection to prevent the IC from overheating. When in thermal protection mode, the charge current will reduce to maintain the safe junction temperature. Operating in thermal protection mode will slow down the charging process. Lowering the input voltage and enhancing thermal dissipation to the environment can effectively prevent the IC from going into thermal protection mode.

APPLICATION

Flow Chart of Operation

Power-On Reset (POR) feature can be applied to the MP26058 to ensure that the device starts operating in a known state. The flow chart in

Figure 4 describes the conditions and operation modes of the MP26058. CVC and CCC stand for “constant voltage charge” and “constant current charge”, respectively.

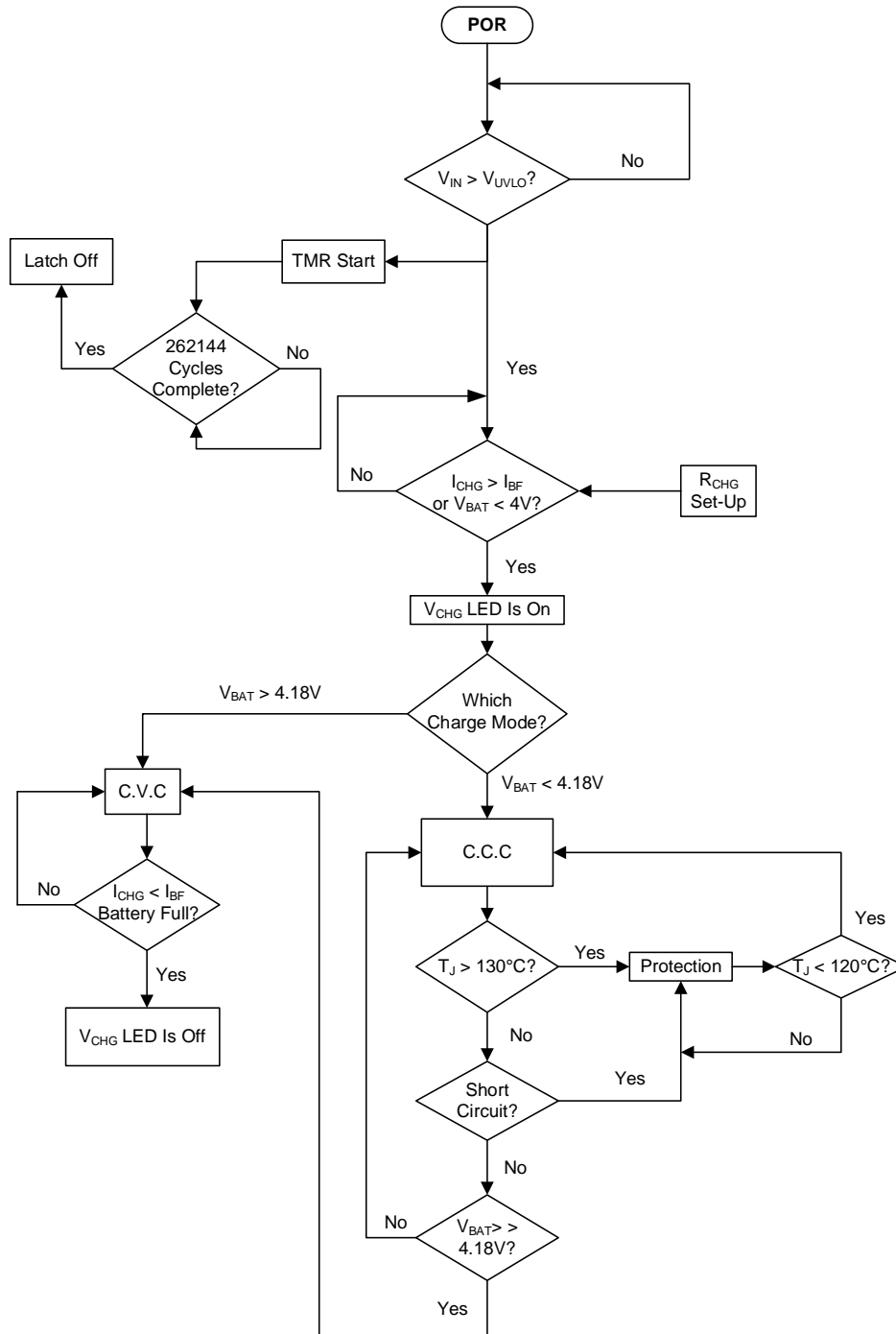
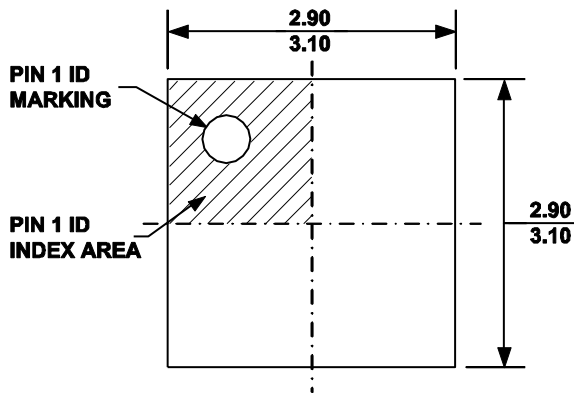

Figure 4 — Flow Chart Operation

PACKAGE INFORMATION

QFN10 (3mm x 3mm)



TOP VIEW

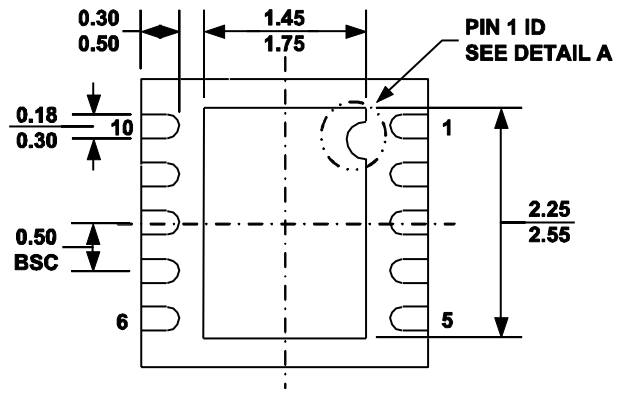

BOTTOM VIEW

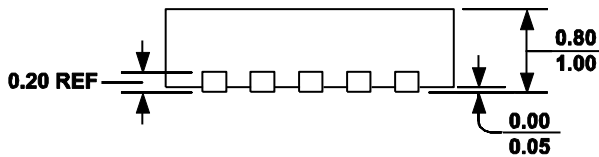

SIDE VIEW

**PIN 1 ID OPTION A
R0.20 TYP.**

**PIN 1 ID OPTION B
R0.20 TYP.**

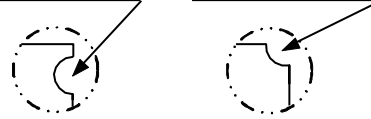

DETAIL A

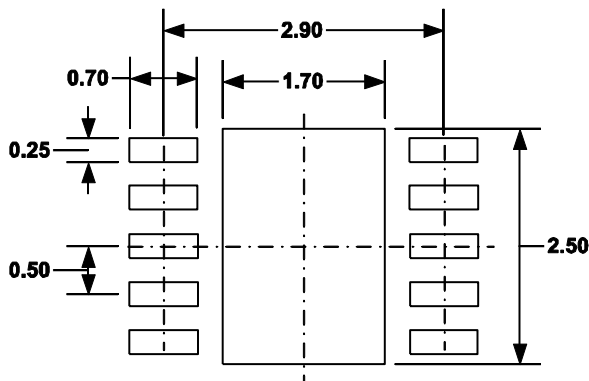

RECOMMENDED LAND PATTERN

NOTE:

- 1) ALL DIMENSIONS ARE IN MILLIMETERS.
- 2) EXPOSED PADDLE SIZE DOES NOT INCLUDE MOLD FLASH.
- 3) LEAD COPLANARITY SHALL BE 0.10 MILLIMETER MAX.
- 4) DRAWING CONFORMS TO JEDEC MO-229, VARIATION VEED-5.
- 5) DRAWING IS NOT TO SCALE.

NOTICE: The information in this document is subject to change without notice. Users should warrant and guarantee that third party Intellectual Property rights are not infringed upon when integrating MPS products into any application. MPS will not assume any legal responsibility for any said applications.