

DESCRIPTION

The MP2377 is a monolithic step-down switch mode converter with a built in high-side power MOSFET. It achieves 3A continuous output current over a wide input supply range with excellent load and line regulation.

Current mode operation provides fast transient response and eases loop stabilization.

Fault condition protection includes current limiting and thermal shutdown.

The MP2377 requires a minimum number of readily available standard external components and is available in 8-pin SOIC packages with exposed pad.

FEATURES

- Wide 4.5V to 21V Operating Input Range
- 3A Output Current
- 100mΩ Internal Power MOSFET Switch
- Power Good Indicator
- Fixed 600kHz Frequency
- Synchronizable to >1MHz External Clock
- Over Current Latch Off Protection
- Thermal Shutdown
- Output Adjustable from 0.81V
- Stable with Low ESR Output Ceramic Capacitors
- Available in Thermally Enhanced 8-Pin SOIC Packages
- Supports Soft-Start into Pre-Biased Output

APPLICATIONS

- Distributed Power Systems
- Battery Charger
- Pre-Regulator for Linear Regulators

"MPS" and "The Future of Analog IC Technology" are Registered Trademarks of Monolithic Power Systems, Inc.

TYPICAL APPLICATION

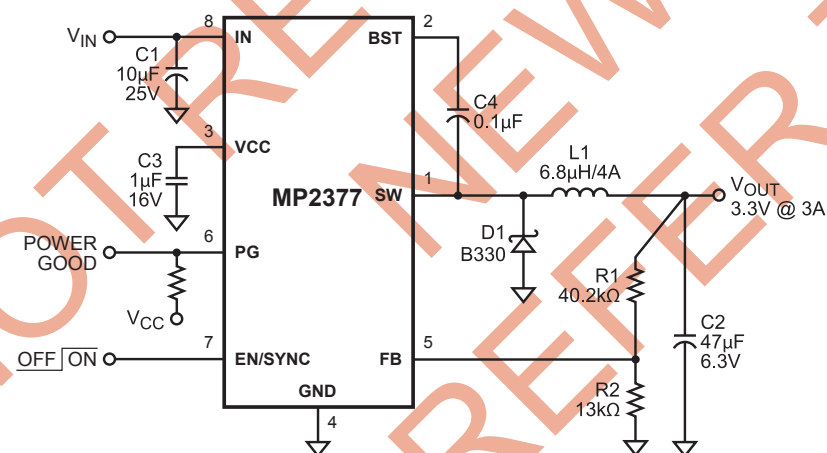

Efficiency vs Load Current

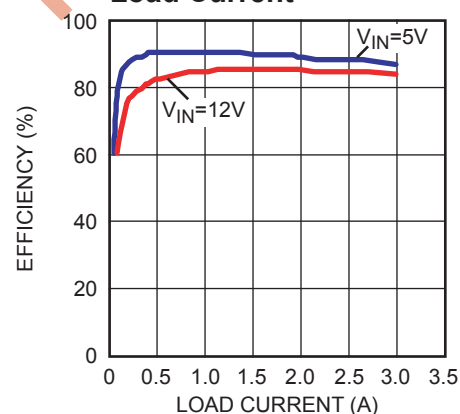

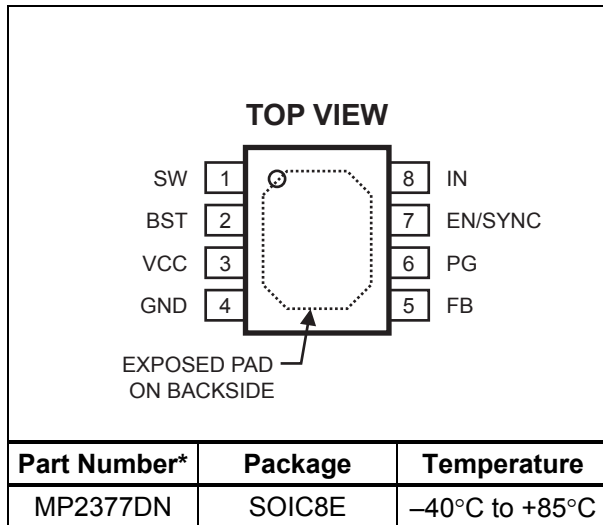
PACKAGE REFERENCE

* For Tape & Reel, add suffix -Z (eg. MP2377DN-Z)
 For RoHS Compliant Packaging, add suffix -LF
 (eg. MP2377DN-LF-Z)

ABSOLUTE MAXIMUM RATINGS ⁽¹⁾

Supply Voltage V_{IN} 23V
 V_{SW} -0.3V(-5V for < 10ns) to 24V
 $V_{BST} - V_{SW}$ + 6V
 All Other Pins..... -0.3V to +6V
 Junction Temperature..... 150°C
 Lead Temperature 260°C
 Storage Temperature -65°C to +150°C

Recommended Operating Conditions ⁽²⁾

Supply Voltage V_{IN} 4.5V to 21V
 Operating Temperature -40°C to +85°C

Thermal Resistance ⁽³⁾ θ_{JA} θ_{JC}
 SOIC8..... 90..... 45... °C/W
 SOIC8E..... 50..... 10... °C/W

Notes:

- 1) Exceeding these ratings may damage the device.
- 2) The device is not guaranteed to function outside of its operating conditions.
- 3) Measured on JESD51-7, 4-layer PCB.

ELECTRICAL CHARACTERISTICS

$V_{IN} = 12V$, $T_A = +25^\circ C$, unless otherwise noted.

| Parameters | Symbol | Condition | Min | Typ | Max | Units |
|--|--------------|-------------------------------|-------|-------|-------|------------|
| Feedback Voltage | V_{FB} | $4.5V \leq V_{IN} \leq 21V$ | 0.788 | 0.808 | 0.828 | V |
| Feedback Current | I_{FB} | $V_{FB} = 0.8V$ | | 10 | | nA |
| | | $V_{FB} = 2V$ | | 2 | | μA |
| Switch On Resistance ⁽⁴⁾ | $R_{DS(ON)}$ | | | 100 | | m Ω |
| Switch Leakage | | $V_{EN} = 0V$, $V_{SW} = 0V$ | | 0.1 | 10 | μA |
| Current Limit ⁽⁴⁾ | | | 4 | | | A |
| Oscillator Frequency | f_{SW} | $V_{FB} = 0.6V$ | | 600 | | KHz |
| Fold-back Frequency | | $V_{FB} = 0V$ | | 150 | | KHz |
| Maximum Duty Cycle | | $V_{FB} = 0.6V$ | 85 | 90 | | % |
| Minimum On Time ⁽⁴⁾ | t_{ON} | | | 100 | | ns |
| Under Voltage Lockout Threshold Rising | | | 3.9 | 4.1 | 4.3 | V |
| Under Voltage Lockout Threshold Hysteresis | | | | 880 | | mV |
| EN Input Low Voltage | | | | | 0.4 | V |
| En Input High Voltage | | | 1.2 | | | V |
| EN Input Current | | $V_{EN} = 2V$ | | 2 | | μA |
| | | $V_{EN} = 0V$ | | 0.01 | | |
| Supply Current (Shutdown) | | $V_{EN} = 0V$ | | 0.1 | | μA |
| Supply Current (Quiescent) | | $V_{EN} = 2V$, $V_{FB} = 1V$ | | 0.9 | | mA |
| Thermal Shutdown | | | | 150 | | °C |
| Bias Supply | V_{CC} | $I_{CC} = 5mA$ | 4.5 | 5.0 | | V |
| Power Good Threshold Rising | | | | 0.74 | | V |
| Power Good Threshold Hysteresis | | | | 40 | | mV |
| PG Pin Level | V_{PG} | PG Sink 4mA | | | 0.4 | V |
| Sync Frequency Range (Low) | F_{SYNCL} | | | 300 | | KHz |
| Sync Frequency Range (High) | F_{SYNCH} | | | 1.5 | | MHz |
| Enable Turnoff Delay | T_{OFF} | | | 5.0 | | μS |

Note:

4) Guaranteed by design.

PIN FUNCTIONS

| Pin # | Name | Description |
|-------|---------|---|
| 1 | SW | Switch Output. |
| 2 | BST | Bootstrap. This capacitor is needed to drive the power switch's gate above the supply voltage. It is connected between SW and BS pins to form a floating supply across the power switch driver. |
| 3 | VCC | Bias Supply. Decouple this pin with a 1 μ F ceramic capacitor. |
| 4 | GND | Ground. This pin is the voltage reference for the regulated output voltage. For this reason care must be taken in its layout. This node should be placed outside of the D1 to C1 ground path to prevent switching current spikes from inducing voltage noise into the part. |
| 5 | FB | Feedback. An external resistor divider from the output to GND, tapped to the FB pin sets the output voltage. To prevent current limit run away during a short circuit fault condition the frequency foldback comparator lowers the oscillator frequency when the FB voltage is below 250mV. |
| 6 | PG | Power Good Indicator. Connect this pin to V _{CC} or V _{OUT} by a 100k Ω pull-up resistor. The output of this pin is low if the output voltage is 10% less than the nominal voltage, otherwise it is an open drain. |
| 7 | EN/SYNC | On/Off Control Input and Synchronization Pin. |
| 8 | IN | Supply Voltage. The MP2377 operates from a +4.5V to +21V unregulated input. C1 is needed to prevent large voltage spikes from appearing at the input. |

TYPICAL PERFORMANCE CHARACTERISTICS

$V_{IN} = 12V$, $V_{OUT} = 3.3V$, $L = 3.3\mu H$, $T_A = +25^\circ C$, unless otherwise noted.

Efficiency vs Load Current

$V_O = 3.3V$, $I_{OUT} = 3A$

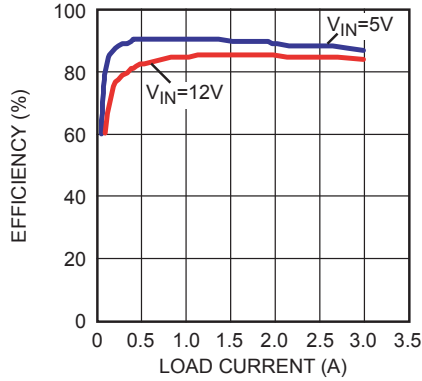

Efficiency vs Load Current

$I_{OUT} = 3A$

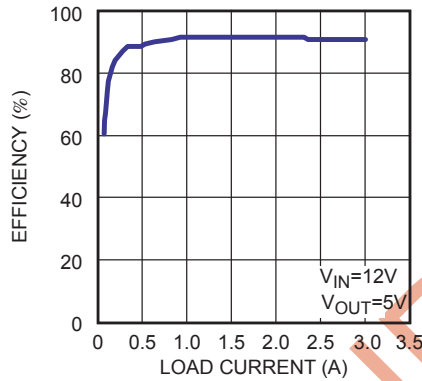

Steady States

$V_{IN} = 12V$, $V_O = 3.3V$, $I_{OUT} = 0.1A$

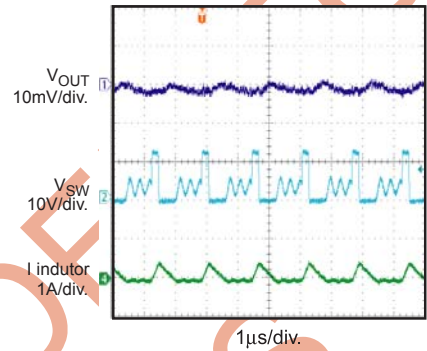

Steady States

$V_{IN} = 12V$, $V_O = 3.3V$, $I_{OUT} = 0=1.5A$

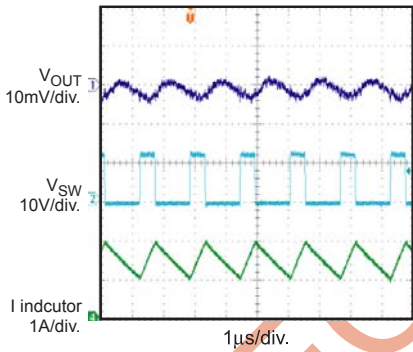

Steady States

$V_{IN} = 12V$, $V_O = 3.3V$, $I_{OUT} = 3A$

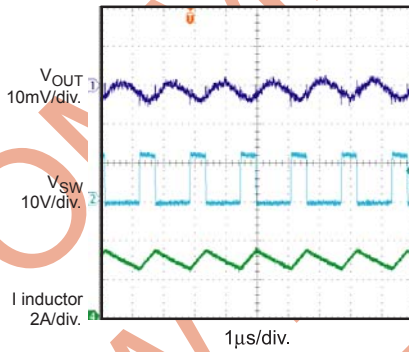

Start Up Through Enable

$V_{IN} = 12V$, $V_O = 3.3V$, $I_{OUT} = 0.1A$

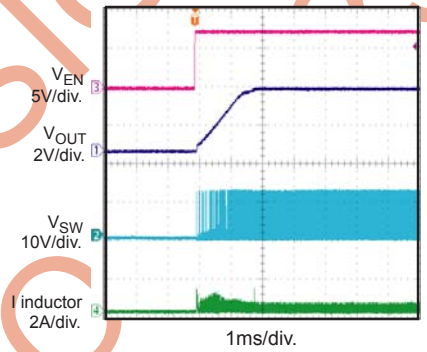

Start Up Through Enable

$V_{IN} = 12V$, $V_O = 3.3V$, $I_{OUT} = 1.5A$

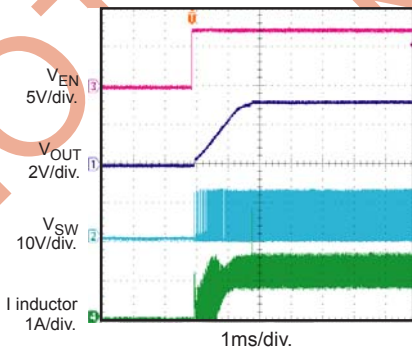

Start Up Through Enable

$V_{IN} = 12V$, $V_O = 3.3V$, $I_{OUT} = 3A$

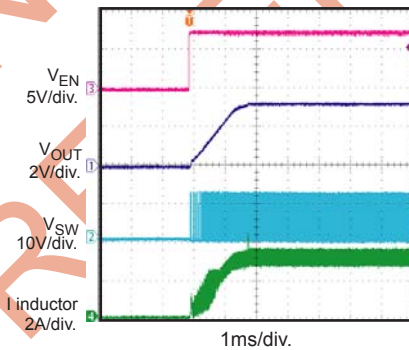

Shutdown Through Enable

$V_{IN} = 12V$, $V_O = 3.3V$, $I_{OUT} = 0.1A$

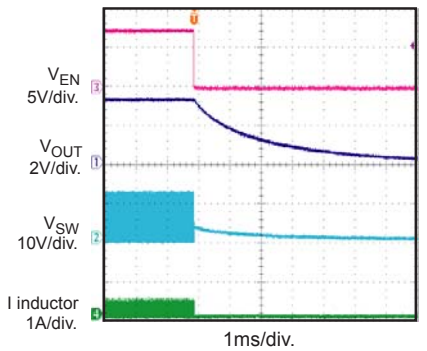

TYPICAL PERFORMANCE CHARACTERISTICS

$V_{IN} = 12V, V_{OUT} = 3.3V, L = 3.3\mu H, T_A = +25^\circ C$, unless otherwise noted.

Shutdown Through Enable

$V_{IN} = 12V, V_O = 3.3V, I_{OUT} = 1.5A$

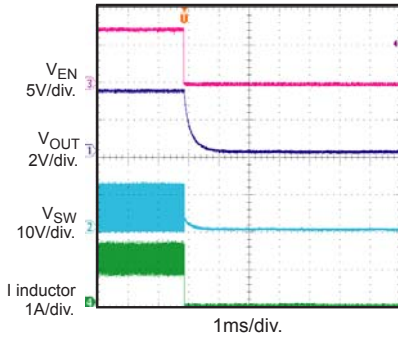

Shutdown Through Enable

$V_{IN} = 12V, V_O = 3.3V, I_{OUT} = 3A$

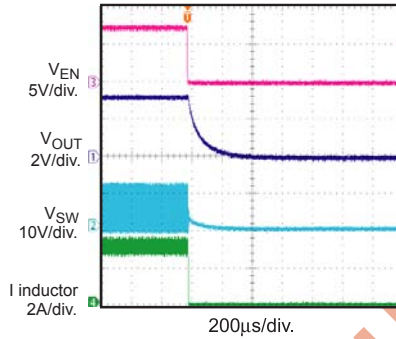

Short Circuit Latch-Off

$V_{IN} = 12V, V_O = 3.3V, I_{OUT} = 0.1A$

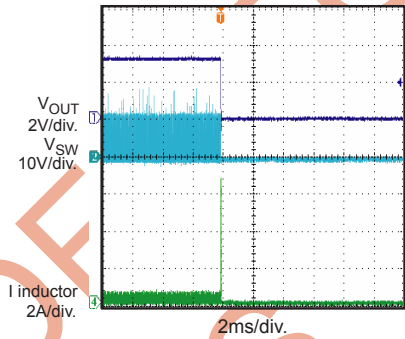

Load Regulation

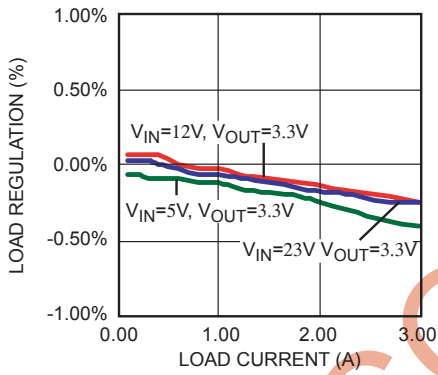

Line Regulation

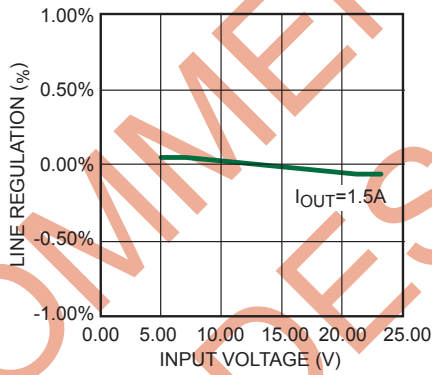

Peak Current vs Duty Cycle

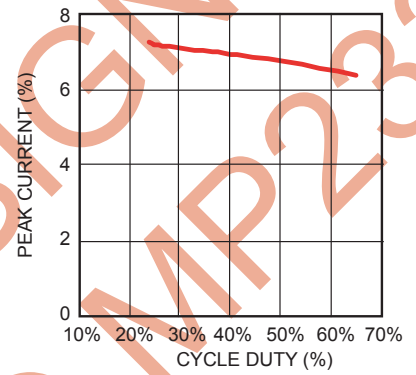

Load Transient

$V_{IN}=12V, V_O=3.3V, I_O=1-2A,$
STEP@1AµS

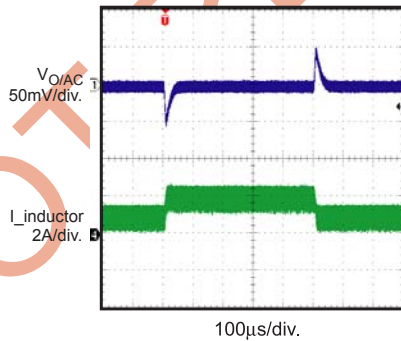

OPERATION

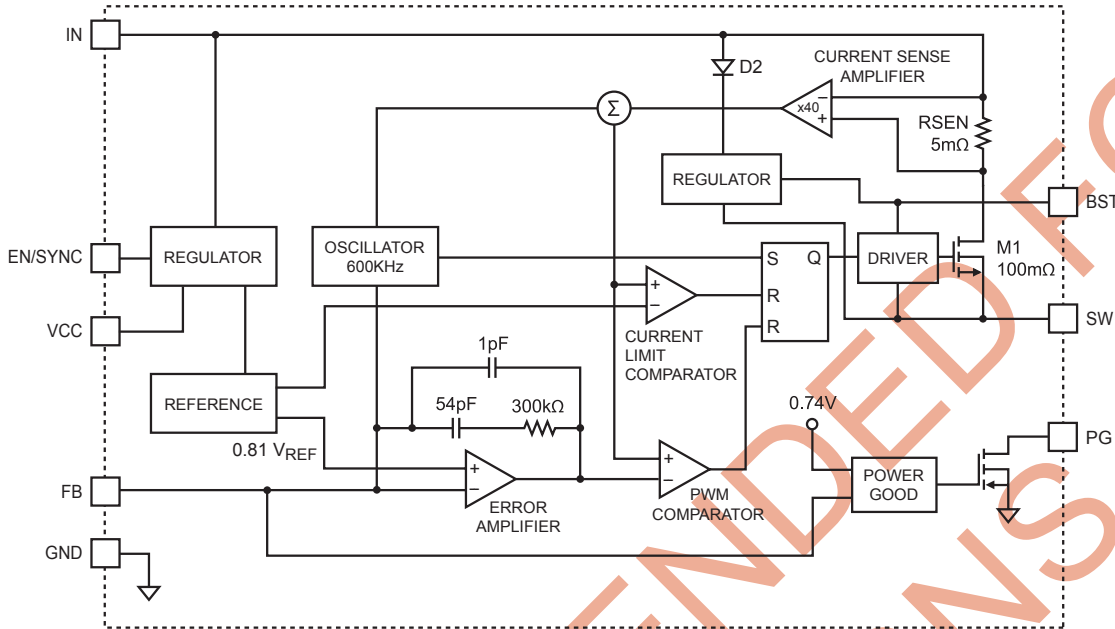

Figure 1—Functional Block Diagram

The MP2377 is a fixed frequency, step-down switching regulator with an integrated high-side power MOSFET. It achieves 3A continuous output current over a wide input supply range with excellent load and line regulation. It provides a single highly efficient solution with current mode control for fast loop response and easy compensation.

The MP2377 operates in a fixed frequency, peak current control mode to regulate the output voltage. A PWM cycle is initiated by the internal clock. The integrated high-side power MOSFET is turned on and remains on until its current reaches the value set by the COMP voltage. When the power switch is off, it remains off until the next clock cycle starts. If, in 90% of one PWM period, the current in the power MOSFET does not reach the COMP set current value, the power MOSFET will be forced to turn off.

Power Good Indicator

When the FB is below 0.74V, the PG pin will be internally pulled low. When the FB is above 0.74V, the PG becomes an open-drain output.

Error Amplifier

The error amplifier compares the FB pin voltage with the internal 0.808V reference (REF) and outputs a current proportional to the difference between the two. This output current is then used to charge or discharge the internal compensation network to form the COMP voltage, which is used to control the power MOSFET current. The optimized internal compensation network minimizes the external component counts and simplifies the control loop design.

Internal Regulator

Most of the internal circuitries are powered from the 5V internal regulator. This regulator takes the VIN input and operates in the full VIN range. When VIN is greater than 5.0V, the output of the regulator is in full regulation. When VIN is lower than 5.0V, the output decreases. Since this internal regulator provides the bias current for the bottom gate driver that requires significant amount of current depending upon the external MOSFET selection, a 1uF ceramic capacitor for decoupling purpose is required.

Enable/Synch Control

The MP2377 has a dedicated Enable/Synch control pin (EN/SYNC). By pulling it high or low, the IC can be enabled and disabled by EN. Tie EN to VIN for automatic start up. To disable the part, EN must be pulled low for at least 5 μ s.

The MP2377 can be synchronized to external clock range from 300KHz up to 1.4MHz through the EN/SYNC pin. The internal clock rising edge is synchronized to the external clock rising edge.

Under-Voltage Lockout (UVLO)

Under-voltage lockout (UVLO) is implemented to protect the chip from operating at insufficient supply voltage. The MP2377 UVLO comparator monitors the output voltage of the internal regulator, VCC. The UVLO rising threshold is about 4.0V while its falling threshold is about 3.6V.

Internal Soft-Start

The soft-start is implemented to prevent the converter output voltage from overshooting during startup. When the chip starts, the internal circuitry generates a soft-start voltage (SS) ramping up from 0V to 1.2V. When it is lower than the internal reference (REF), SS overrides REF so the error amplifier uses SS as the reference. When SS is higher than REF, REF regains control.

Over-Current-Protection and Latchoff

The MP2377 has cycle-by-cycle over current limit when the inductor current peak value exceeds the set current limit threshold. Meanwhile, output voltage starts to drop until FB is below the Under-Voltage(UV) threshold, typically 30% below the reference. Once a UV is triggered, the MP2377 is latched off until En or IN is recycled. This protection mode is especially useful when the output is dead-short to ground.

Thermal Shutdown

Thermal shutdown is implemented to prevent the chip from operating at exceedingly high temperatures. When the silicon die temperature is higher than 150°C, it shuts down the whole chip. When the temperature is lower than its lower threshold, typically 140°C, the chip is enabled again.

Floating Driver and Bootstrap Charging

The floating power MOSFET driver is powered by an external bootstrap capacitor. This floating driver has its own UVLO protection. This UVLO's rising threshold is 2.2V with a hysteresis of 150mV. The bootstrap capacitor voltage is regulated internally (Figure 2). Even at no load condition, as long as V_{IN} is 3V higher than V_{OUT} , C4 will have enough voltage provided by V_{IN} through D2, M2, C4, L1 and C2. If $(V_{IN}-V_{SW})$ is more than 5V, U2 will regulate M2 to maintain a 5V BST voltage across C4.

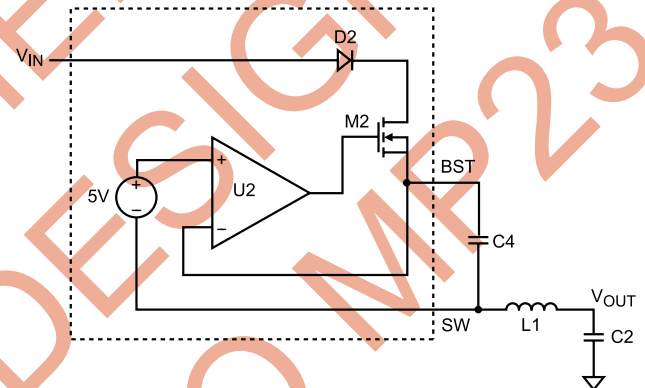

Figure 2—Internal Bootstrap Charging Circuit

Startup and Shutdown

If both V_{IN} and EN are higher than their appropriate thresholds, the chip starts. The reference block starts first, generating stable reference voltage and currents, and then the internal regulator is enabled. The regulator provides stable supply for the remaining circuitries.

Three events can shut down the chip: EN low, V_{IN} low and thermal shutdown. In the shutdown procedure, the signaling path is first blocked to avoid any fault triggering. The COMP voltage and the internal supply rail are then pulled down. The floating driver is not subject to this shutdown command.

APPLICATION INFORMATION

The schematic on the front page shows a typical MP2377 application. The IC can provide up to 3A output current at a nominal output voltage of 3.3V. For proper thermal performance, the exposed pad of the device must be soldered down to the printed circuit board.

Setting the Output Voltage

The external resistor divider is used to set the output voltage (see the schematic on front page). The feedback resistor R1 also sets the feedback loop bandwidth with the internal compensation capacitor (see Figure 1). Choose R1 to be around 40.2kΩ for optimal transient response. R2 is then given by:

$$R2 = \frac{R1}{\frac{V_{OUT}}{0.8V} - 1}$$

Table 1—Resistor Selection for Common Output Voltages

| V _{OUT} (V) | R1 (kΩ) | R2 (kΩ) |
|----------------------|-----------|-----------|
| 1.8 | 40.2 (1%) | 32.4 (1%) |
| 2.5 | 40.2 (1%) | 19.1 (1%) |
| 3.3 | 40.2 (1%) | 13 (1%) |
| 5 | 40.2 (1%) | 7.68 (1%) |

Selecting the Inductor

A 1μH to 10μH inductor with a DC current rating of at least 25% percent higher than the maximum load current is recommended for most applications. For highest efficiency, the inductor DC resistance should be less than 15mΩ. For most designs, the inductance value can be derived from the following equation.

$$L = \frac{V_{OUT} \times (V_{IN} - V_{OUT})}{V_{IN} \times \Delta I_L \times f_{OSC}}$$

Where ΔI_L is the inductor ripple current.

Choose inductor current to be approximately 30% of the maximum load current, 3A. The maximum inductor peak current is:

$$I_{L(MAX)} = I_{LOAD} + \frac{\Delta I_L}{2}$$

Under light load conditions below 100mA, larger inductance is recommended for improved efficiency.

Output Rectifier Diode

The output rectifier diode supplies the current to the inductor when the high-side switch is off. To reduce losses due to the diode forward voltage and recovery times, use a Schottky diode.

Choose a diode whose maximum reverse voltage rating is greater than the maximum input voltage, and whose current rating is greater than the maximum load current. Table 2 lists example Schottky diodes and manufacturers.

Table 2—Diode Selection Guide

| Diode | Voltage/Current Rating | Manufacture |
|---------|------------------------|-------------|
| B330 | 30V, 3A | Diodes Inc. |
| MBRS330 | 30V, 3A | On Semi |

Selecting the Input Capacitor

The input capacitor (C1) reduces the surge current drawn from the input and the switching noise from the device. The input capacitor impedance at the switching frequency should be less than the input source impedance to prevent high frequency switching current from passing to the input. Ceramic capacitors with X5R or X7R dielectrics are highly recommended because of their low ESR and small temperature coefficients. For 3A output applications, a 10μF capacitor is sufficient.

Selecting the Output Capacitor

The output capacitor (C2) keeps output voltage small and ensures regulation loop stability. The output capacitor impedance should be low at the switching frequency. Ceramic capacitors with X5R or X7R dielectrics are recommended.

PCB Layout Guide

PCB layout is very important to achieve stable operation. Please follow these guidelines and take Figure 3 and 4 for references.

- 1) Keep the path of switching current short and minimize the loop area formed by Input cap, high-side MOSFET and schottky diode.
- 2) Keep the connection of schottky diode between SW pin and input power ground as short and wide as possible.
- 3) Ensure all feedback connections are short and direct. Place the feedback resistors and compensation components as close to the chip as possible.
- 4) Route SW away from sensitive analog areas such as FB.
- 5) Connect IN, SW, and especially GND respectively to a large copper area to cool the chip to improve thermal performance and long-term reliability. For single layer PCB, exposed pad should not be soldered.

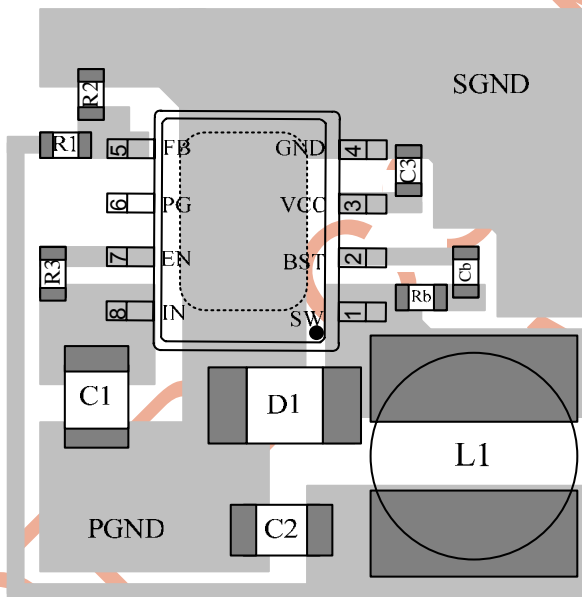

Figure 3—PCB Layout for Single Layer

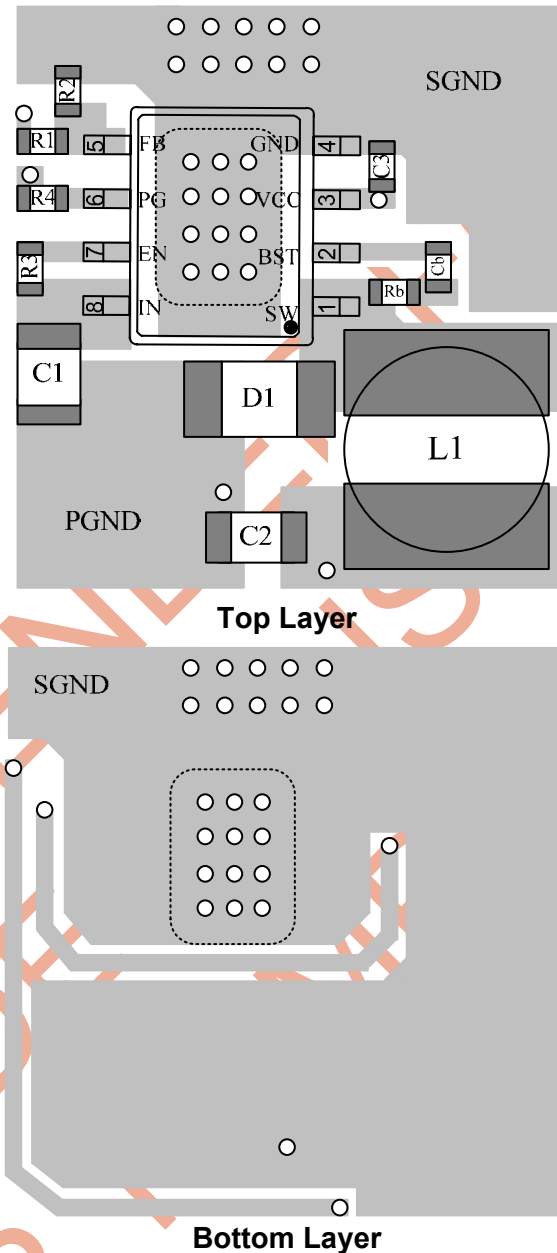

Figure 4—PCB Layout for Double Layers

External Bootstrap Diode

An external bootstrap diode may enhance the efficiency of the regulator, the applicable conditions of external BST diode are:

- $V_{OUT}=5V$ or $3.3V$; and
- Duty cycle is high: $D = \frac{V_{OUT}}{V_{IN}} > 65\%$

In these cases, an external BST diode is recommended from the output of the voltage regulator to BST pin, as shown in Fig.5

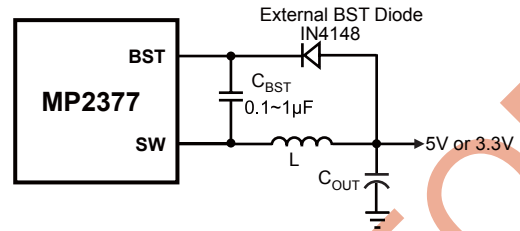

Figure 5—Add Optional External Bootstrap Diode to Enhance Efficiency

The recommended external BST diode is IN4148, and the BST cap is $0.1\sim 1\mu F$.

By using this circuit, 5V input voltage can output 3.3V and 2.5V with just 30mA load.

PACKAGE INFORMATION

SOIC8E (EXPOSED PAD)

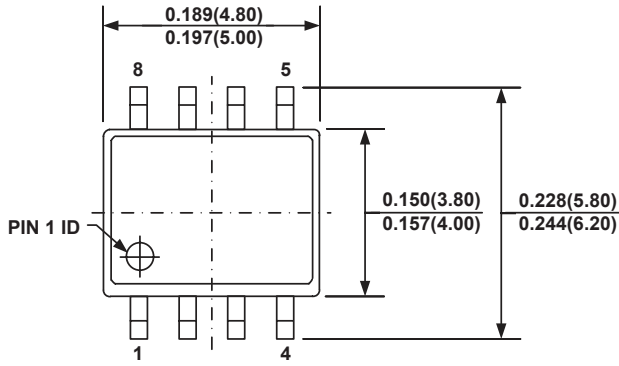

TOP VIEW

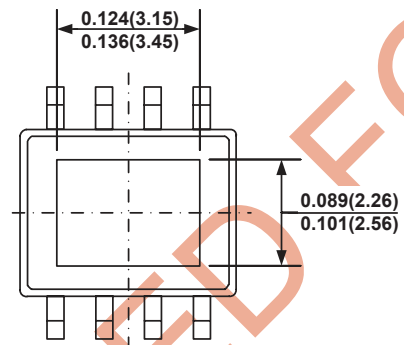

BOTTOM VIEW

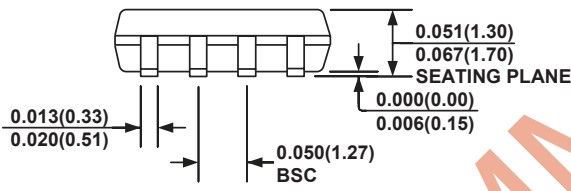

FRONT VIEW

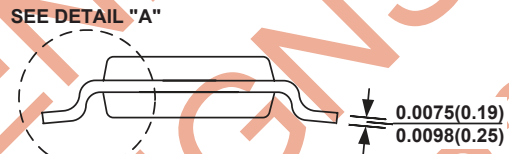

SIDE VIEW

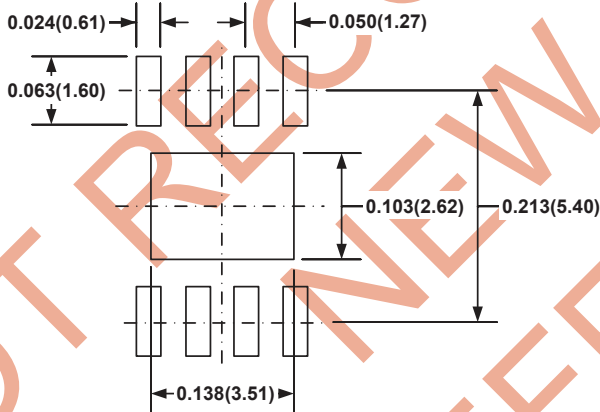

RECOMMENDED LAND PATTERN

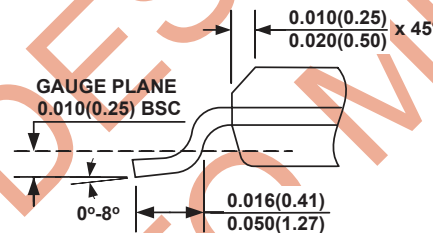

DETAIL "A"

NOTE:

- 1) CONTROL DIMENSION IS IN INCHES. DIMENSION IN BRACKET IS IN MILLIMETERS.
- 2) PACKAGE LENGTH DOES NOT INCLUDE MOLD FLASH, PROTRUSIONS OR GATE BURRS.
- 3) PACKAGE WIDTH DOES NOT INCLUDE INTERLEAD FLASH OR PROTRUSIONS.
- 4) LEAD COPLANARITY (BOTTOM OF LEADS AFTER FORMING) SHALL BE 0.004" INCHES MAX.
- 5) DRAWING CONFORMS TO JEDEC MS-012, VARIATION BA.
- 6) DRAWING IS NOT TO SCALE.