



The Future of Analog IC Technology®

EVQ2451-G-33-00A

0.6A, 2MHz, 36V Step-Down Converter Evaluation Board

DESCRIPTION

The EVQ2451-G-33-00A is an evaluation board for the MPQ2451, a fixed 2MHz frequency step-down switching regulator with an integrated internal high-side high voltage power MOSFET. The IC provides 0.6A output with current mode control for fast loop response and easy compensation.

High power conversion efficiency over a wide load range is achieved by scaling down the switching frequency at light load condition to reduce the switching and gate driving losses.

The soft-start function helps prevent inductor current runaway during startup and thermal shutdown provides reliable, fault tolerant operation.

By switching at 2MHz, smaller value inductor and input/output capacitor can be used to lower down cost and save board space.

FEATURES

- Wide Operating Input Range
- Fixed 2MHz Switching Frequency
- 0.6A Output Current
- Up to 90% Efficiency
- Fixed 3.3V Output Voltage

APPLICATIONS

- High Voltage Power Conversion
- Automotive Systems
- Industrial Power Systems
- Distributed Power Systems
- Battery Powered Systems

All MPS parts are lead-free, halogen free, and adhere to the RoHS directive. For MPS green status, please visit MPS website under Quality Assurance. "MPS" and "The Future of Analog IC Technology" are Registered Trademarks of Monolithic Power Systems, Inc.

ELECTRICAL SPECIFICATIONS

Parameter	Symbol	Value	Units
Input Voltage	V_{IN}	6-32	V
Output Voltage	V_{OUT}	3.3	V
Output Current	I_{OUT}	0-0.6	A

EVQ2451-G-33-00A EVALUATION BOARD



(L x W x H) 1.8" x 1.8" x 0.4"
4.6cm x 4.6cm x 1.0cm

Board Number	MPS IC Number
EVQ2451-G-33-00A	MPQ2451-G-33

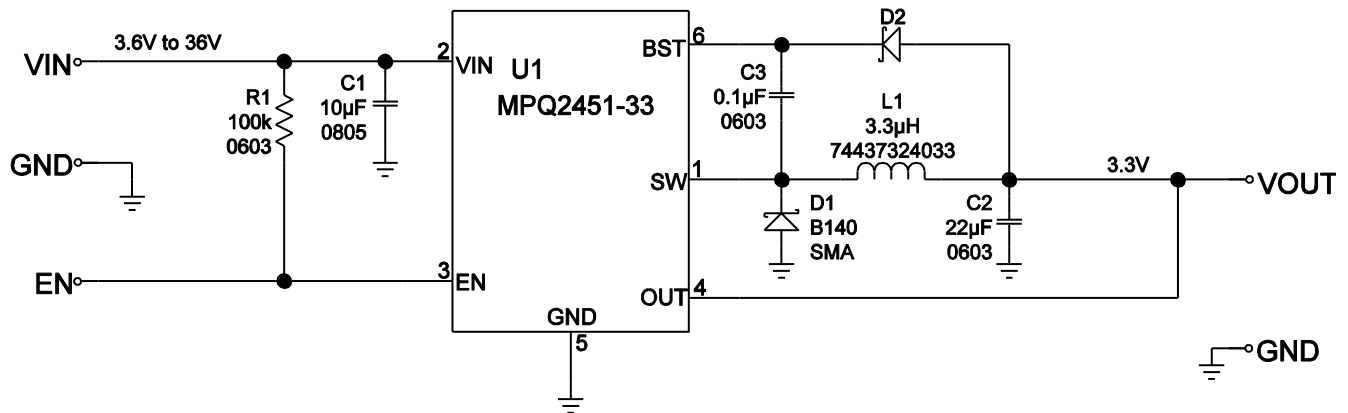
EVALUATION BOARD SCHEMATIC

EVQ2451-G-33-00A BILL OF MATERIALS

Qty	Ref	Value	Description	Package	Manufacturer	Part Number
1	C1	10µF	Ceramic Cap., 25V, 10%, X5R	0805	muRata	GRM21BR61E106KA73L
1	C2	22µF	Ceramic Cap., 6.3V, 20%, X5R	0603	TDK	C1608X5R0J226M080AC
1	C3,	0.1µF	Ceramic Cap., 25V, 10%, X7R	0603	muRata	GRM188R71E104KA01D
1	D1	B140	Schottky Rect., 40V, 1A	SMA	Diodes Inc	B140-13-LF
2	D2	NS				
1	L1	3.3µH	Inductor, I _{dc} =2.15A	SMD 4x4mm	Würth	WE-744373240-33
1	R1	100kΩ	Film Res., 1%	0603	Yageo	RC0603FR-07100KL
1	U1	MPQ2451-33	Power Driver	QFN6L-2X2mm	MPS	MPQ2451-G-33-R3
4	VIN, GND, VOUT, GND		Power Test Point	2.3mm	HZ	China market
1	EN, GND		3x2.54mm Test Point	3x2.54 mm	Sullins	PCC03SAAN

EVB TEST RESULTS

$V_{IN}=12V$, $V_{OUT}=3.3V$, $L=3.3\mu H$, $I_{OUT}=0.6A$, $T_A=25^\circ C$, unless otherwise noted.

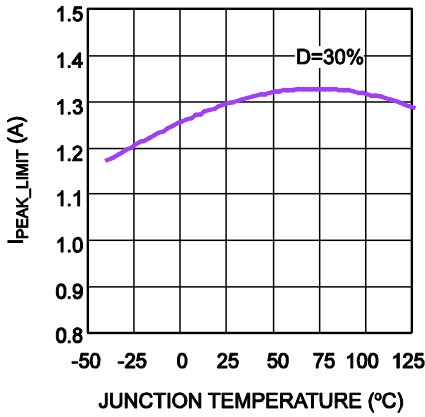
Current Limit vs. Junction Temperature



Frequency vs. Junction Temperature

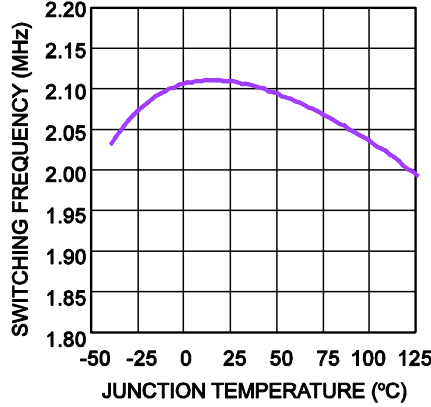

Voltage Reference vs. Junction Temperature

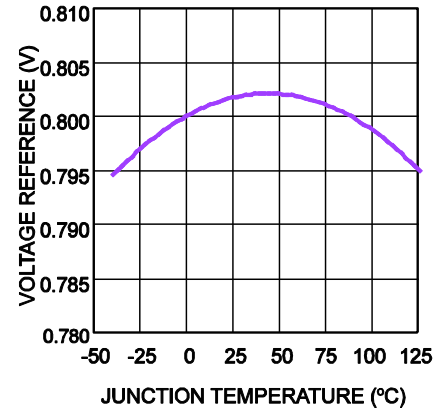

Load Efficiency

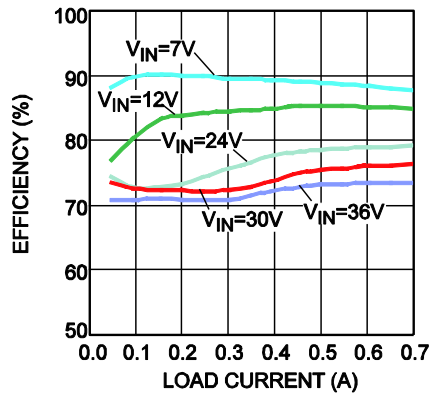

Line Efficiency

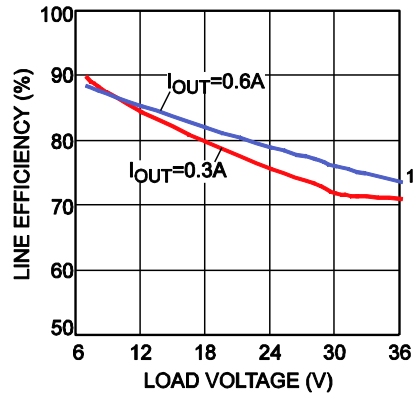

Load Transient

$V_{IN} = 7V$, $I_{OUT} = 50mA-0.6A$

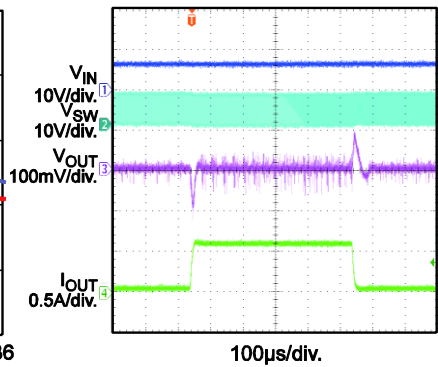

Load Regulation

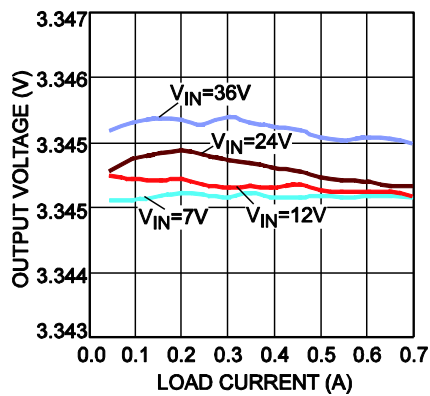

Line Regulation

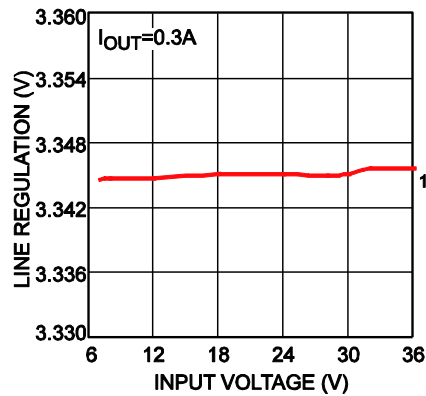

Load Transient

$V_{IN} = 12V$, $I_{OUT} = 50mA-0.6A$

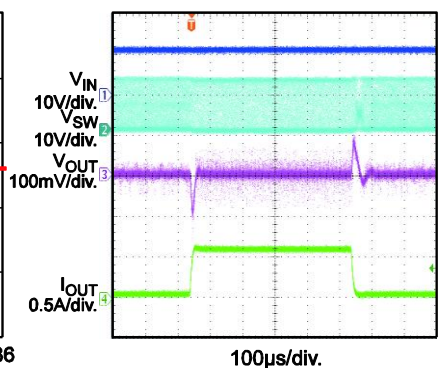

EVB TEST RESULTS (continued)

$V_{IN}=12V$, $V_{OUT}=3.3V$, $L=3.3\mu H$, $I_{OUT}=0.6A$, $T_A=25^\circ C$, unless otherwise noted.

Steady State

$V_{IN} = 32V$, $I_{OUT} = 0.6A$

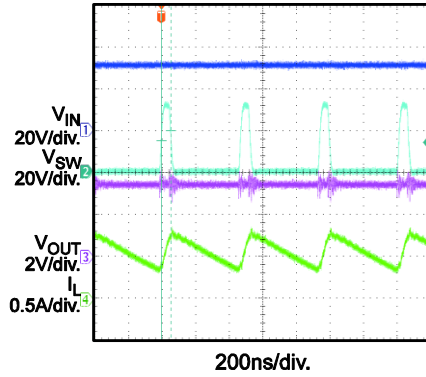

Enable On

$V_{IN} = 12V$, $I_{OUT} = 0.5A$

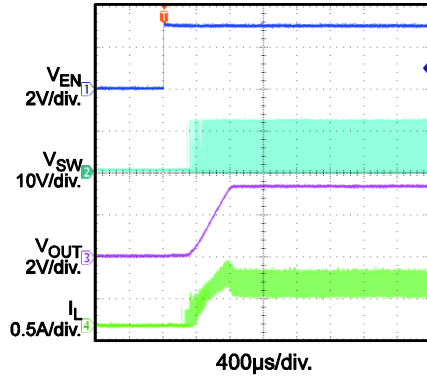

Enable Off

$V_{IN} = 12V$, $I_{OUT} = 0.5A$

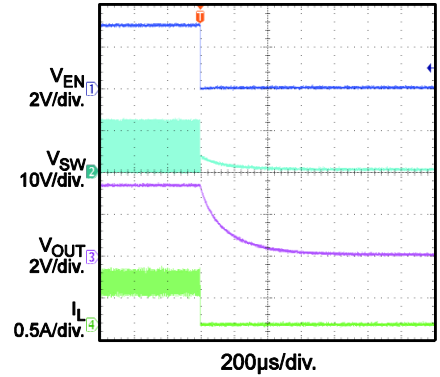

Short Output

$V_{IN} = 12V$, $I_{OUT} = 0.5A$

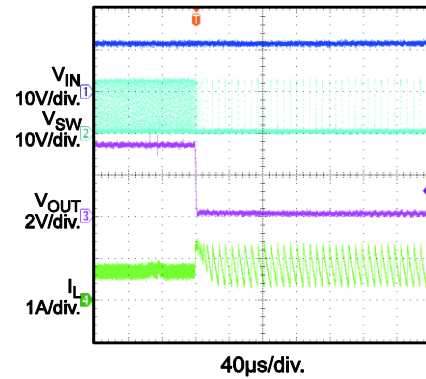

Short Output Recovery

$V_{IN} = 12V$, $I_{OUT} = 0.5A$

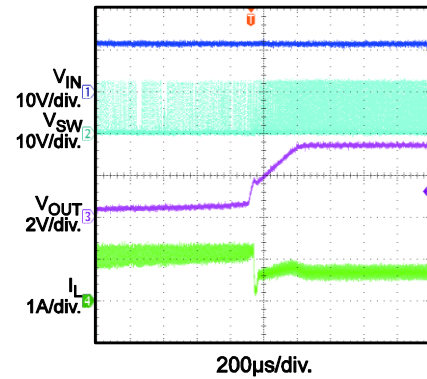

Short Output Start Up

$V_{IN} = 7V$, $I_{OUT} = 0.5A$

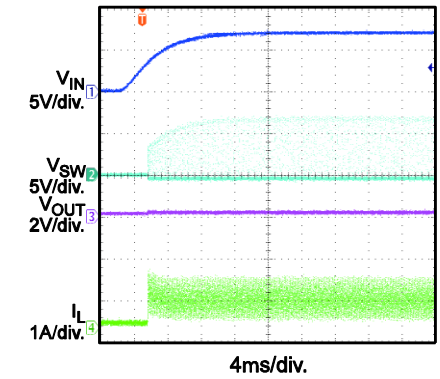

Power Ramp Up

$V_{IN} = 12V$, $I_{OUT} = 0.5A$

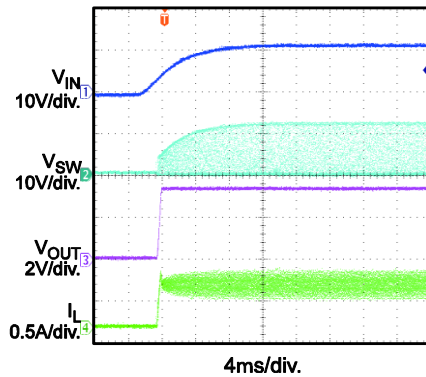

Power Ramp Down

$V_{IN} = 12V$, $I_{OUT} = 0.5A$

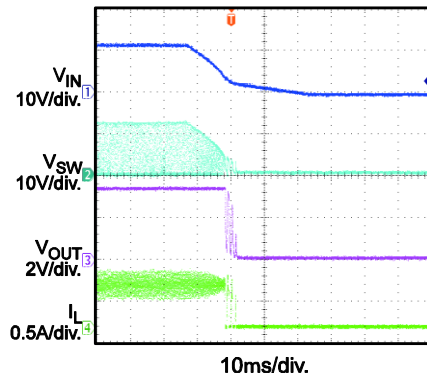

Steady State

$V_{IN} = 5.7V$, $I_{OUT} = 0.6A$

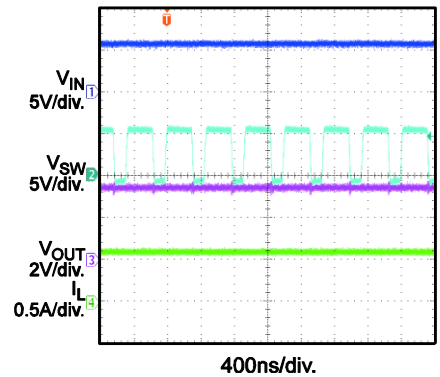

PRINTED CIRCUIT BOARD LAYOUT

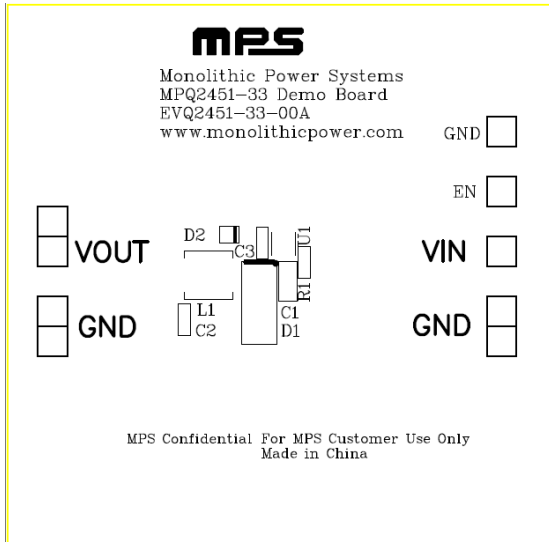

Figure 1—Top Silk Layer

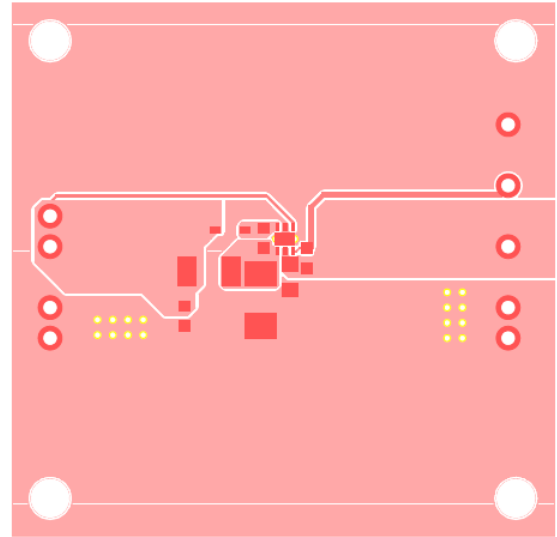

Figure 2—Top Layer

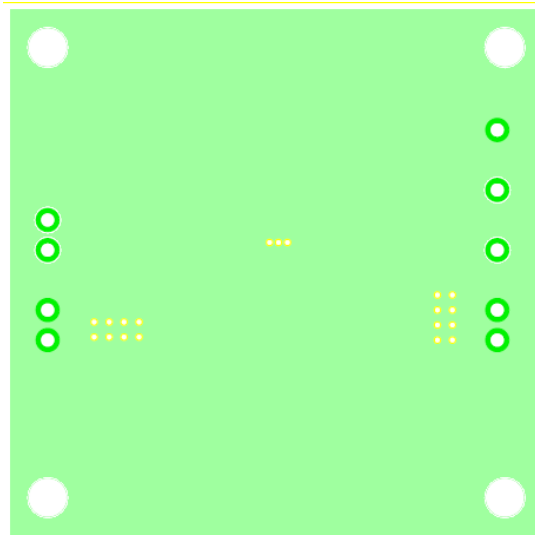

Figure 3—Bottom Layer

QUICK START GUIDE

1. Connect the positive terminal of the load to VOUT pins, and the negative terminal of the load to GND pins.
2. Preset the power supply output to 12V and turn off the power supply.
3. Connect the positive terminal of the power supply output to the VIN pin and the negative terminal of the power supply output to the GND pin.
4. Turn on the power supply. The EVQ2451 will automatically start up.
5. To use the Enable function, apply a digital input to the EN pin. Drive EN higher than 1.6V to turn on the regulator or less than 1.2V to turn it off. Note that floating the EN pin will turn it off.
6. The output voltage is fixed 3.3V.

NOTICE: The information in this document is subject to change without notice. Users should warrant and guarantee that third party Intellectual Property rights are not infringed upon when integrating MPS products into any application. MPS will not assume any legal responsibility for any said applications.