



EVKT-MSM957094-36

eMotion System™ Smart Motor Module

Evaluation Kit

FEATURES

The **EVKT-MSM957094-36 evaluation kit** is part of a family of fully integrated smart motor solutions for servo motor applications. This 57mm (NEMA 23), 94W motor integrates a brushless DC motor and a smart motor module. The user can program the system to operate in speed control mode, position control mode, or torque control mode. Two control interface options are available: an RS485 interface and a PULSE/DIR interface.

Easy-to-use GUI software provides flexibility by allowing users to optimize the design online through the RS485 control interface. The parameters are saved in the motor module's non-volatile memory. A design guide for the GUI is available for download at www.monolithicpower.com.

The smart motor modules can be ordered separately for customization into different motor types. The **MMP757094-36** is the driver module part number used in the kit.

The datasheet for the **MMP757094-36** is available for download at www.monolithicpower.com.

DESCRIPTION

- 18V to 70V Input Voltage Range
- Max 94W Continuous Power Output
- 0.3N-m Rated Torque (0.9N-m Peak Torque)
- 0.3° Position Resolution
- RS485 Interface and PULSE/DIR Interface
- Position, Speed, and Torque Control Modes
- Operating Temperature: 0°C to 70°C (Power Derated > 40°C)
- Storage Temperature: -40°C to +125°C

ORDERING INFORMATION

Part Number	EVKT-MSM957094-36
Diameter (mm)	57
Power (W)	94
Typical Voltage (V)	36
Interface	RS485

Evaluation Kit EVKT-MSM957094-36 Contents

#	Part Number	Item	Quantity
1	EVKT-MSM957094-36	BLDC motor with MMP757094-36 smart motor module installed	1
2	eMotion System™ communication kit	USB communication interface with cable	1



EVALUATION KIT SPECIFICATIONS

Smart Motor Module Evaluation Kit			
Parameter	Condition	Value	Units
Input voltage		36	V
Output power	0°C to 40°C	94	W
Position resolution		0.3	°
Nominal speed		3000	rpm
Nominal torque		0.3	N-m
Rotor inertia		210	g-cm ²
Diameter		57	mm
Shaft diameter		8	mm
Length	Body only	76	mm
Weight		900	g

RECOMMENDED OPERATING CONDITIONS

Input voltage..... 18V to 70V
 Control interface voltage..... 0V to 5.5V
 Max pulse frequency500kHz
 RS485 A/B voltage 0V to 5.5V
 RS485 common mode voltage.....±15V
 Operation temperature..... 0°C to 70°C
 Storage temperature..... -40°C to +125°C

HARDWARE CONNECTIONS

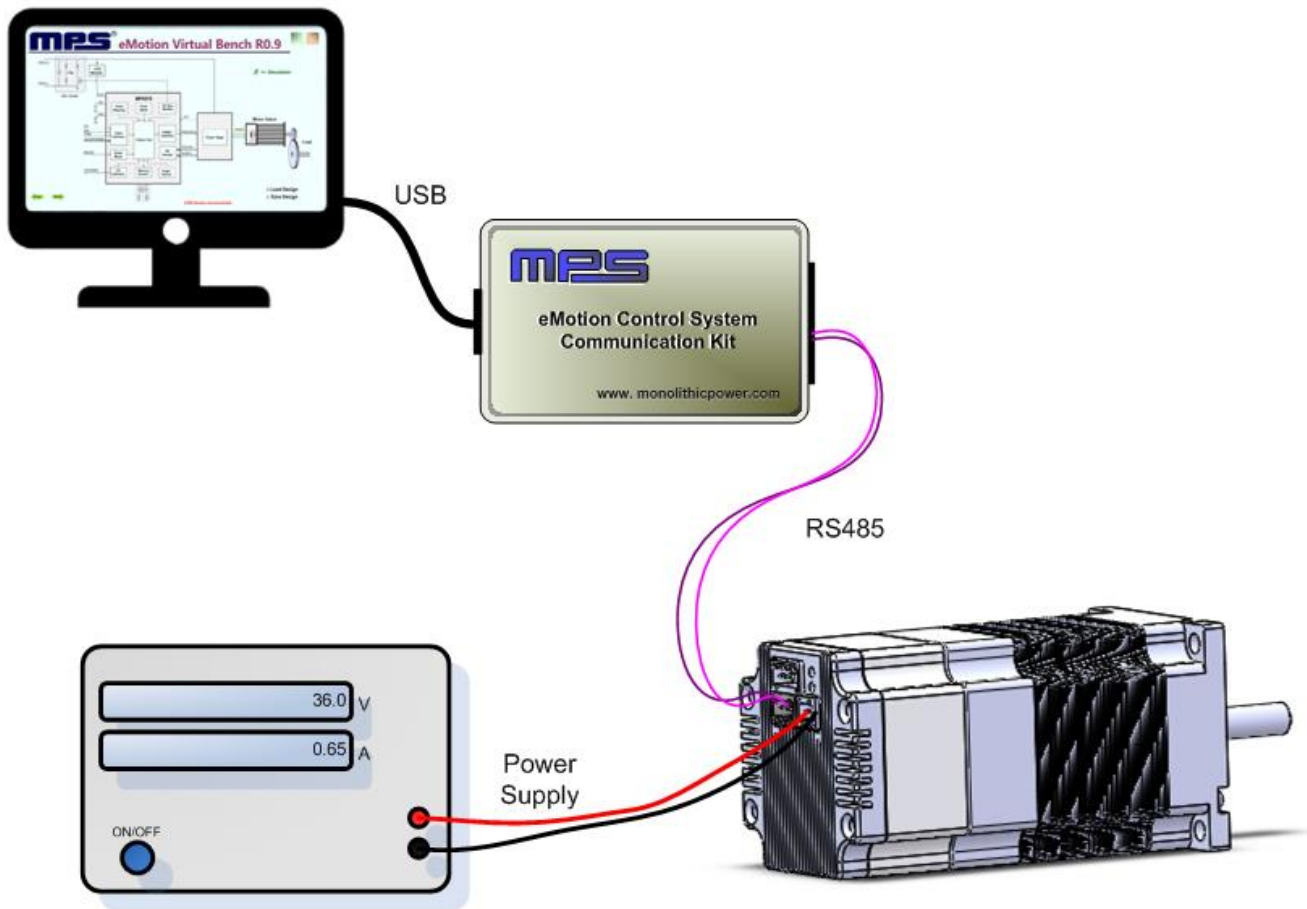

PIN CONFIGURATION

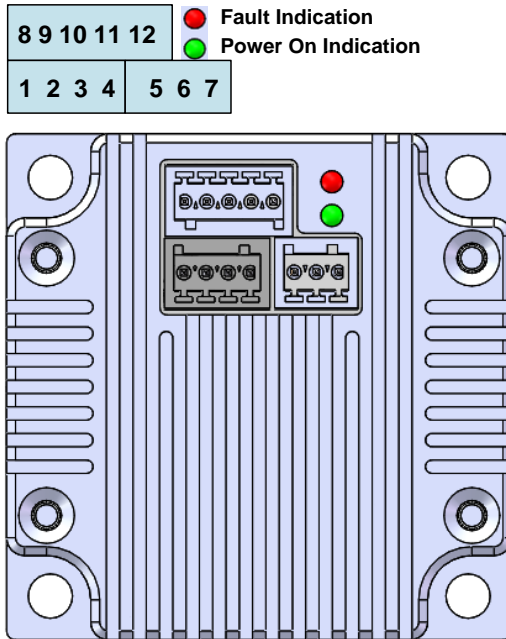

Pin Number	Designation	Pin Description
RS485 Interface		
1	EXT_5V	5V input for firmware programming
2	B	RS485 node B
3	AGND	RS485 ground
4	A	RS485 node A
Power Interface		
5	GND	Power ground
6	R-	Shunt resistor return node
7	VIN	Input power supply
Control Interface		
8	COM-	Common return
9	EN+	Enable input
10	PEND+	Position end output
11	PUL+	Pulse input
12	DIR+	Direction input

TYPICAL PERFORMANCE CHARACTERISTICS

$T_A = 25^\circ\text{C}$, $V_{IN} = 36\text{V}$, unless otherwise noted.

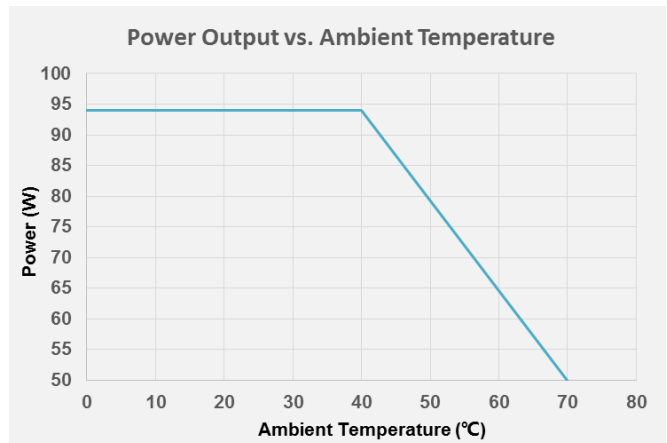
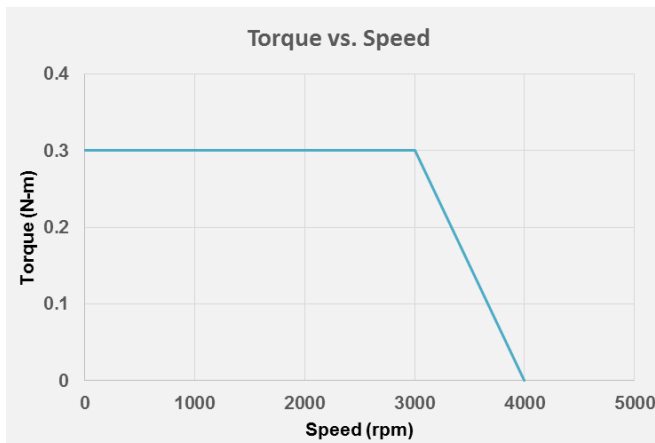

MECHANICAL DRAWING

