



User Guide

MP2723 Evaluation Kit (EVKT-MP2723)

Table of Contents

Overview	2
Introduction	2
Kit Contents	2
Features and Benefits	3
Kit Specifications	4
Section 1. Hardware Specifications	5
1.1 Personal Computer Requirements	5
1.2 EV2723-QC-00A Specifications	5
1.3 EVKT-USBI2C-02 Specifications	5
Section 2. Software Requirements	6
2.1 Software Installation Procedure	6
Section 3. Evaluation Kit Test Set-Up	7
3.1 Hardware Set-Up	7
3.2 Powering Up the EVB	7
3.3 Software Set-Up	8
3.4 Troubleshooting Tips	9
Section 4. Ordering Information	10

Overview

Introduction

The EVKT-MP2723 is an evaluation kit for the MP2723. This board is designed for the MP2723 when used as a standalone switching charger with integrated USB detection and USB OTG function. Its layout accommodates most commonly used capacitors. The default function of this board is preset for charger mode, and the charge-full voltage is preset to 4.2V for a single-cell Li-ion battery.

Kit Contents

EVKT-MP2723 kit contents (items below can be ordered separately, and the GUI installation file and supplemental documents can be downloaded from the MPS website):

#	Part Number	Item	Quantity
1	EV2723-QC-00A	MP2723 evaluation board	1
2	EVKT-USBI2C-02 bag	Include one USB to I ² C communication kit, one USB cable, and one ribbon cable	1

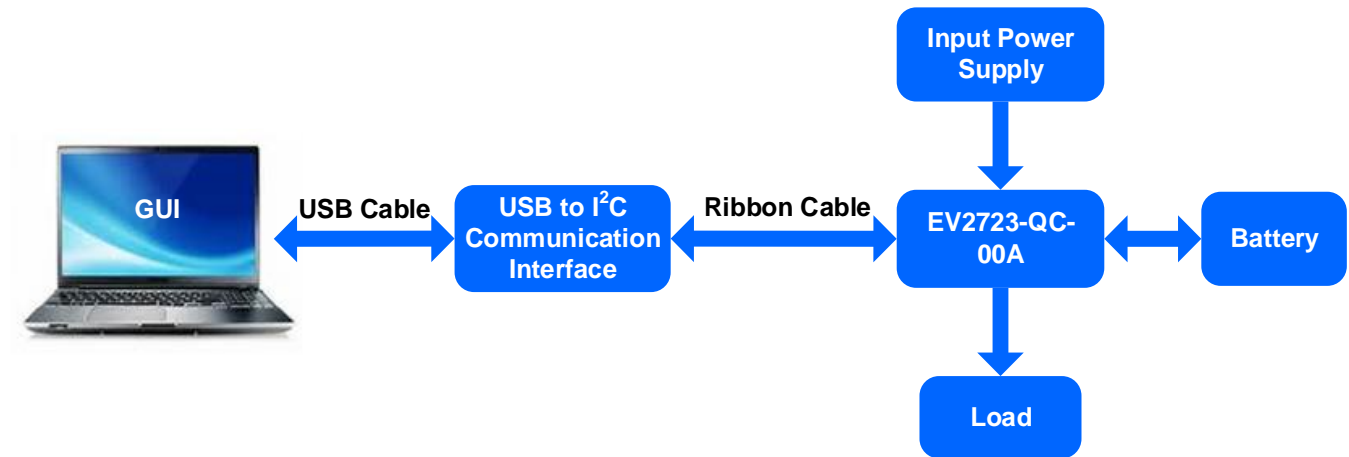

Figure 1: EVKT-MP2723 Evaluation Kit Set-Up

Features and Benefits

- 3.7V to 5.5V Operating Input Voltage Range
- Up to 22V Sustainable Voltage
- High-Efficiency, 3A, 1.35MHz Buck Charger
 - D+/D- Detection for BC1.2
 - Adjustable Minimum Input Voltage Regulation for Maximum Power Point Tracking
- USB On-the-Go (OTG) with Adjustable Output from 4.8V to 5.5V
 - Selectable 1.35MHz Boost Converter
 - Up to 1.5A Output Current
- Up to 9A Battery Discharge Current
- Integrated ADC for Monitoring Input Voltage, Input Current, Battery Voltage, Charge Current, System Voltage, and Battery Temperature
- Narrow Voltage DC (NVDC) Power Path Management
 - Instant-On Works with No Battery or Deeply Discharged Battery
 - Ideal Diode Operation in Battery Supplemental Mode
- Constant-Off-Time Control to Reduce Charging Time under Lower Input Voltage Conditions
- I²C Port for Flexible System Parameter Setting and Status Reporting
- Full DISC Control to Support Shipping Mode and System Restart
- High Accuracy
 - ±0.5% Charge Voltage Regulation
 - ±5% Charge Current Regulation
 - ±5% Input Current Regulation
 - ±2% Output Regulation in Boost Mode
- High Integration
 - Fully Integrated Power Switches and No External Blocking Diode
 - Built-In Robust Charging Protection, Including Battery Temperature Monitoring and Programmable Timer
 - Built-In Battery Disconnection Function
- Safety
 - Programmable JEITA for Battery Temperature Protection
 - Thermal Regulation and Thermal Shutdown
 - Watchdog Monitoring I²C Operation
 - Input/System Over-Voltage Protection
 - MOSFET Over-Current Protection
 - Support Temperature Protection in Battery Side
- Charging Operation Indicator
- On-Chip Thermal Limiting Regulation

⚠ All changes made in I²C mode will not be retained once the EVB is powered down.

⚠ Information written in OTP mode cannot be changed.

Adjustable features:

I ² C	OTP
<ul style="list-style-type: none"> • Charge-Full Voltage • Charge Current • Input Voltage Regulation • Input Current Limit • Pre-Charge Current • Charge Termination Current • V_{SYSTM} MIN Regulation Current • Auto-Recharge Threshold • NTC Comparing Ratio • OTG Voltage Regulation • OTG Current Limit 	<ul style="list-style-type: none"> • I_{INLIM} Default Value • V_{INMIN} Default Value • I_{CC} Default Value • V_{BATTREG} Default Value • CHG_TMR Default Value • IINLIM RESET_EN Default Status • VINMIN RESET_EN Default Status • ADDRESS Default Status • PFM_EN Default Status

Kit Specifications

Feature	Specification
Supply for Board	3.7V to 5.5V
Operating Input Voltage	3.7V to 5.5V
Operating Systems Supported	Windows XP, 7, and later
System Requirements	Minimum 22.2MB free
GUI Software	MP2723 V1.0

Section 1. Hardware Specifications

1.1 Personal Computer Requirements

The following minimum requirements must be met to use the EVKT-MP2723:

- Operating system of Windows XP, 7, or later
- Net Framework 4.0
- PC with a minimum of one available USB port
- At least 22.2MB of free space

1.2 EV2723-QC-00A Specifications

The EV2723-QC-00A is an evaluation board for the MP2723. For more information, refer to the EV2723-QC-00A datasheet.



Figure 2: EV2723-QC-00A Evaluation Board

Feature	Specification
Supply for Evaluation Board	3.7V to 5.5V
Operating Input Voltage	3.7V to 5.5V
EVB Size (LxW)	6.3cmx6.3cm

1.3 EVKT-USBI2C-02 Specifications

The EVKT-USBI2C-02 refers to the USB-to-I²C communication interface, which connects the EVB, the PC, and its supporting accessories. It provides I²C capabilities. Together with MPS’s Virtual Bench Pro and GUI tools, it provides a quick and easy way to evaluate the performance of MPS digital products. For more details, refer to the EVKT-USBI2C-02 datasheet.



Figure 3: EVKT-USBI2C-02 Communication Interface

Section 2. Software Requirements

2.1 Software Installation Procedure

Programming occurs through the MPS I²C GUI. Follow the instructions below to install the software:

Note: This software can be downloaded from the MPS website on the EVKT-MP2723 product page.

1. Download and extract the zip package titled “MP2723 I2C Evaluation GUI”.
2. Double-click the .exe file to open the software (see Figure 4). If a protection window comes up, click “More info,” then click “Run anyway.”
3. Follow the prompts in the set-up guide.
4. Wait for the status screen to verify that installation is complete (see Figure 5).

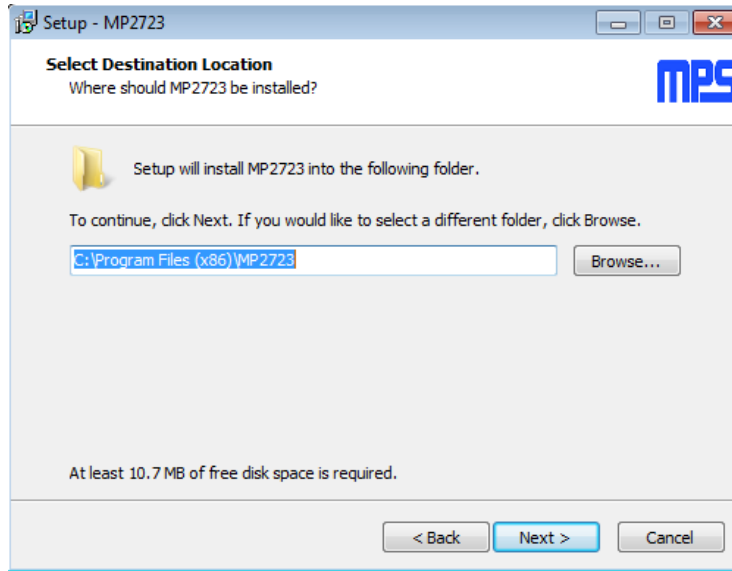

Figure 4: MPS I²C GUI Set-Up Guide

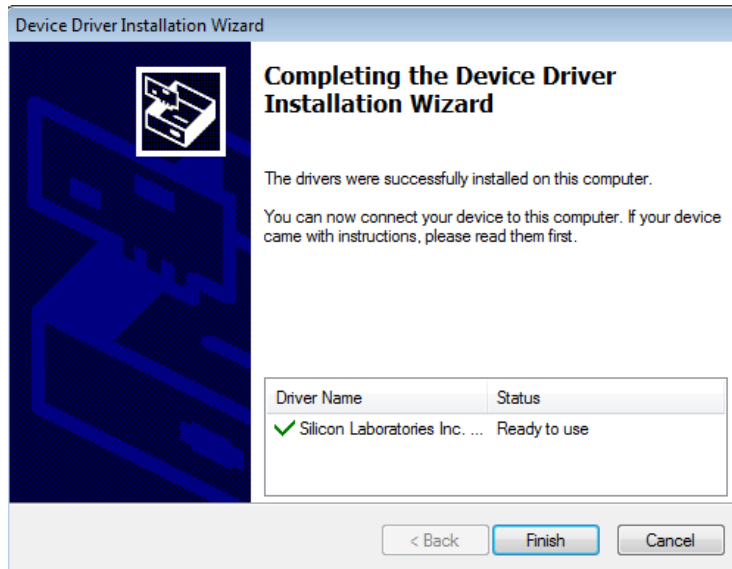

Figure 5: Driver Set-Up Success

Section 3. Evaluation Kit Test Set-Up

3.1 Hardware Set-Up

The hardware must be properly configured prior to use. Follow the instructions below to set up the EVB:

1. Locate the proper wires to connect the EVB to the EVKT-USBI2C-02 communication interface.
2. Connect SCL, SDA, and GND (see Figure 6). Refer to the MP2723 datasheet for further clarification.

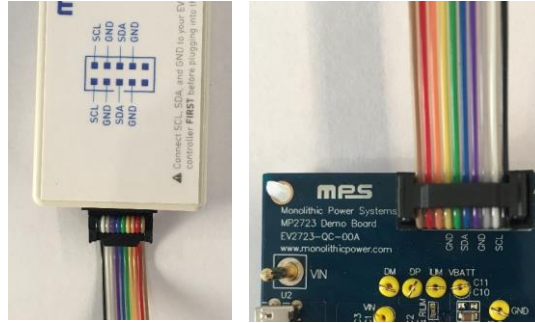

Figure 6: EVB to MPS I²C Communication Interface Wire Connection

3.2 Powering Up the EVB

1. Connect the load to:
 - a. Positive (+): VSYS
 - b. Negative (-): PGND
2. Connect the battery terminals to:
 - a. Positive (+): VBATT
 - b. Negative (-): PGND
3. If using a battery simulator, preset the battery voltage between 0V and 4.2V, then turn it off.
 - a. Connect the battery simulator output to the BATT and PGND pins, respectively.
4. Preset the power supply output between 3.7V and 5.5V, then turn off the power supply.
5. Connect the power supply output terminals to:
 - a. Positive (+): VIN
 - b. Negative (-): PGND
6. Ensure the battery voltage is present (if a battery simulator is used, turn on the battery simulator). Turn the power supply on. The device should start up automatically.

3.3 Software Set-Up

After connecting the hardware according to the steps above, follow the steps below to use the GUI software:

1. Start the software. It should automatically check the EVB connection.
 - If the connection is successful, both the USB and MP2723 demo board statuses will be listed as “Connected” (see Figure 7).

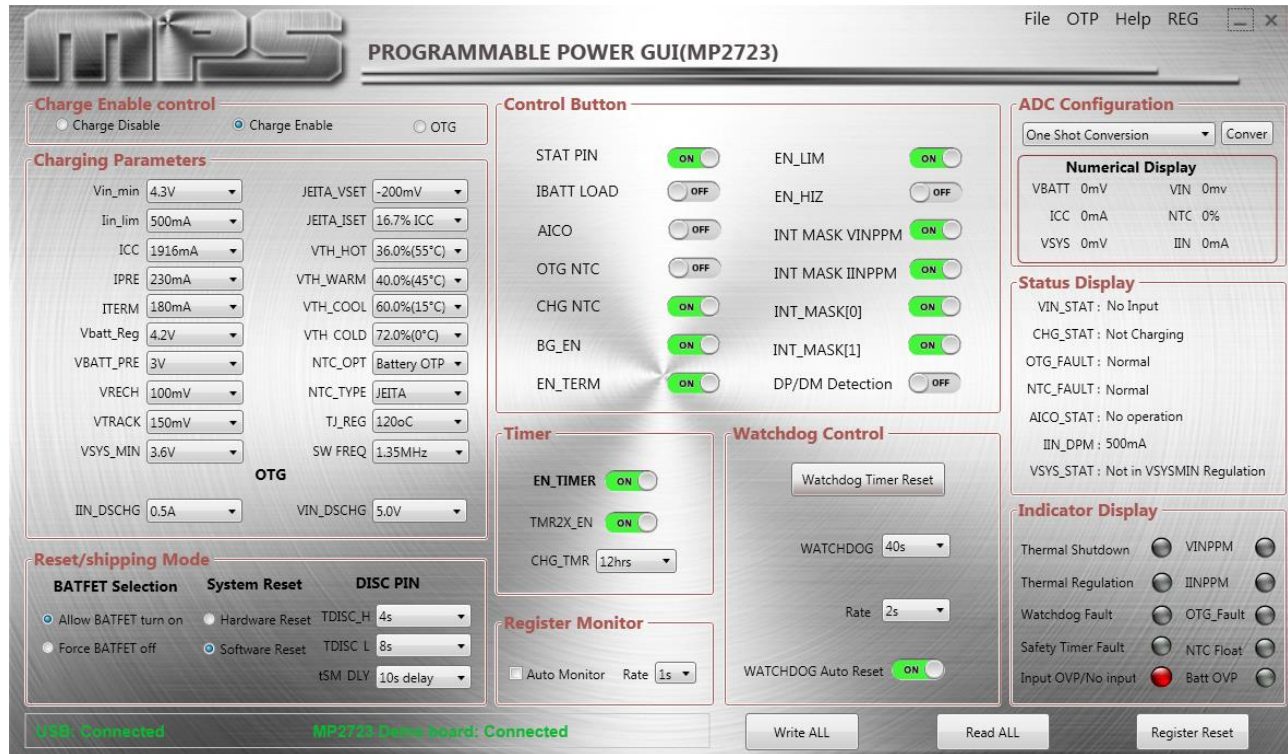

Figure 7: Connected USB and MP2723 Demo Board

- If the connection is unsuccessful, they will be listed as “Not Connected” in red. In this case, check the connections between the EVB, communication interface, and PC. Re-plug the USB into the computer.
 - 1) If the MP2723 demo board is listed as “Not Connected,” this means that the evaluation board is not connected correctly.
 - 2) If the USB is listed as “Not Connected,” this means that the USB I²C communication interface is not connected correctly.
2. Click the “Read All” button to read the I²C register values. The default values are displayed (see Figure 7).
 3. Find the item to be changed, and select the desired value from the drop-down menu.
 4. Click the “Write All” button to update values. The changed information should then download to the IC.

⚠ All changes made via I²C will be restored to default values once the EVB shuts down.

3.4 Troubleshooting Tips

EVKT-USBI2C-02 Driver Problem

If the USBI2C-02 driver is not properly installed, manual installation is required. Follow the steps below:

1. Install the correct USBXpress “.exe” file according to the Windows operating system (32-bit or 64-bit).
 - 32-bit: \EVKT-USBI2C-02 USB Driver\USBXpressInstaller_x86.exe
 - 64-bit: \EVKT-USBI2C-02 USB Driver\USBXpressInstaller_x64.exe
2. Connect the communication interface to the PC with the USB cable.
3. Find “USBXpress Device” in the Device Manager under USB controllers.

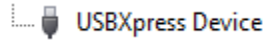

Note: Ensure the driver version matches the newest version. Right-click and view properties. If the PC is running Windows 10, Windows 10 may automatically install the older USB driver, which is not compatible. The correct driver version should be newer than 4.0.0.0 (see Figure 8).

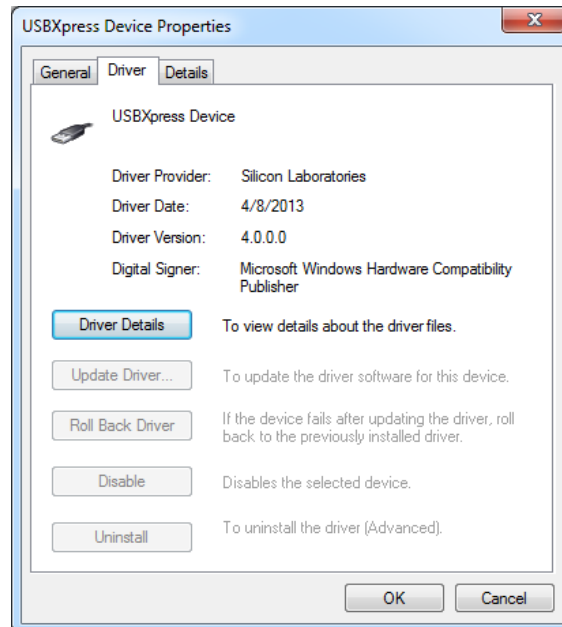

Figure 8: Correct Driver Version Should Be Newer than 4.0.0.0

No Supply

The IC’s input pin has an under-voltage lockout (UVLO) detection circuit. If the input voltage (V_{IN}) is below the UVLO rising threshold, the charging function is disabled.

No Charging Event

If the IC detects that the input voltage is below the UVLO falling threshold (device enters a no-supply state) or over-temperature protection is triggered (device enters a shutdown state), the IC stops switching and charging is suspended.

Thermal Recovery

If the MP2723 is in a shutdown state due to the die temperature exceeding the thermal protection threshold, the IC powers on again once the die temperature decreases.

Section 4. Ordering Information

The components of the evaluation kit can be purchased separately, depending on user needs, and the GUI installation file and supplemental documents can be downloaded from the MPS website.

Part Number	Description
EVKT-MP2723	Complete evaluation kit
Contents of EVKT-MP2723	
EV2723-QC-00A	MP2723 evaluation board
EVKT-USBI2C-02 bag	Include one USB to I ² C USB communication interface, one USB cable, and one ribbon cable

Order directly from MonolithicPower.com or our distributors.

Revision History

Revision #	Revision Date	Description	Pages Updated
1.0	6/1/2020	Initial Release	-