

## DESCRIPTION

The EV2269-D-00A demonstrates MPS's MP2269, a fully-integrated, high efficiency, synchronous step-down switch mode converter with built-in high-side and low-side power MOSFETs. MP2269 provides up to 1A continuous output current over a wide input supply range with current mode control for fast loop response.

Full protection features include over-current protection (OCP) and thermal shutdown (TSD).

The Evaluation Board can deliver 1A continuous load current over a wide input range with excellent load and line regulation.

This part requires minimum number of external components and is available in QFN15 (2mmx3mm) package

## ELECTRICAL SPECIFICATION

Parameter	Symbol	Value	Units
Input Voltage	V <sub>IN</sub>	12	V
Output Voltage	V <sub>OUT</sub>	3.3	V
Output Current	I <sub>OUT</sub>	1	A
Switching Frequency	f <sub>SW</sub>	500	kHz

## FEATURES

- Wide 3.3V to 30V Operating Input Range
- 1A Continuous Output Current
- 1µA Low Shutdown Supply Current
- 12µA Sleep Mode Quiescent Current
- 180mΩ/80mΩ High Side/Low Side RDS(ON) for Internal Power MOSFETs
- 350kHz to 2.5MHz Programmable Switching Frequency
- Power Good Output
- External Soft Start
- 80ns Minimum On Time
- Selectable Forced PWM Mode and Auto PFM/PWM Mode
- Low Dropout Mode
- Hiccup Over Current Protection
- QFN-15 (2mmx3mm)

## APPLICATIONS

- Battery Powered Systems
- Smart Home
- Wide Input Range Power Supply
- Standby Power Supply

All MPS parts are lead-free and adhere to the RoHS directive. For MPS green status, please visit MPS website under Products, Quality Assurance page.

"MPS" and "The Future of Analog IC Technology", are Registered Trademarks of Monolithic Power Systems, Inc.

## EV2269-D-00A EVALUATION BOARD



Board Number	MPS IC Number
EV2269-D-00A	MP2269GD

Efficiency vs. Load Current  
V<sub>OUT</sub>=3.3V, L=6.5µH

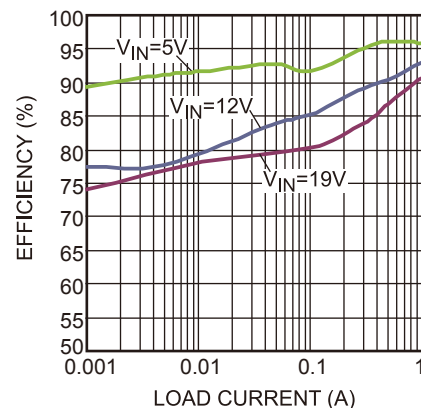

## EVALUATION BOARD SCHEMATIC

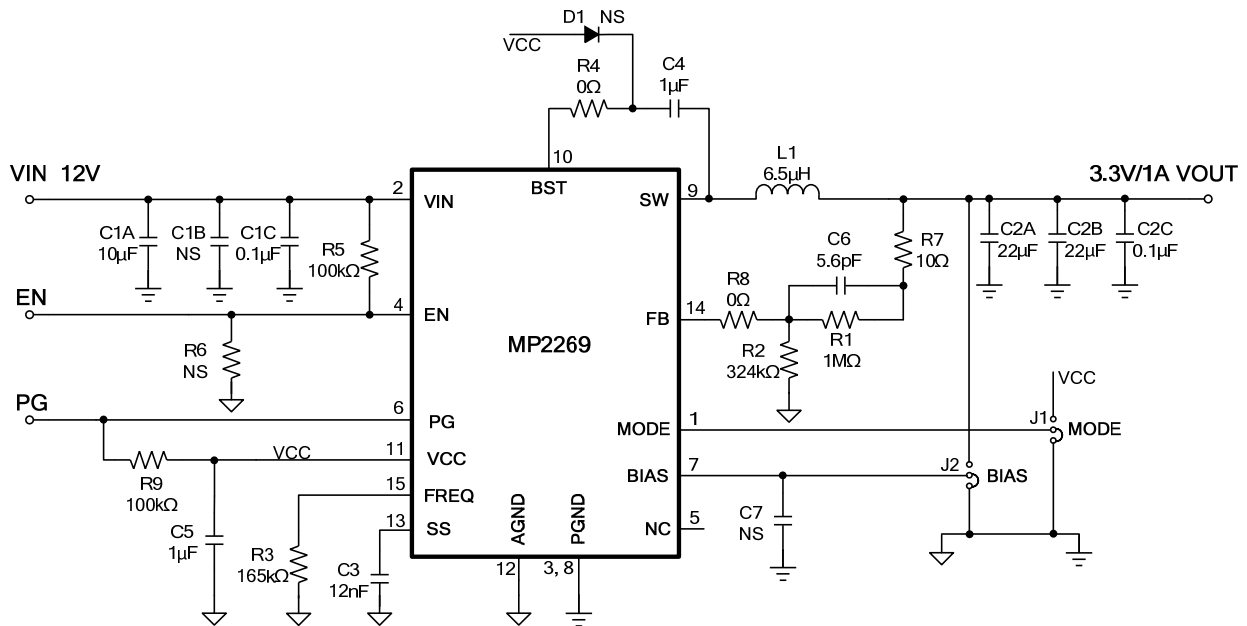

## EV2269-D-00A BILL OF MATERIALS

Qty	Ref	Value	Description	Package	Manufacturer	Manufacturer P/N
1	C1A	10µF	Ceramic Cap, 50V, X5R	1206	TDK	C3216X5R1H106K
0	C1B, C7	NS				
2	C1C,C2C	0.1µF	Ceramic Cap, 350V, X7R	0603	TDK	C1608X7R1H104K
2	C2A,C2B	22µF	Ceramic Cap, 16V, X5R	1206	Murata	GRM31CR61C226ME15L
1	C3	12nF	Ceramic Cap, 50V, X7R	0603	Murata	GRM188R71H123KA01D
2	C4,C5	1µF	Ceramic Cap, 25V, X7R	0603	Murata	GRM188R71E105KA12D
1	C6	5.6pF	Ceramic Cap, 50V, C0G	0603	Murata	GRM1885C1H5R6DZ01D
0	D1	NS				
1	L1	6.5µH	DCR=21.5mΩ, Isat=6A	SMD	Würth	744314650
1	R1	1MΩ	Film Res, 1%	0603	ROYAL	RL0603FR-071ML
1	R2	324kΩ	Film Res, 1%	0603	ROYAL	RL0603FR-07324KL
1	R3	165kΩ	Film Res, 1%	0603	ROYAL	RL0603FR-07165KL
2	R4,R8	0Ω	Film Res, 1%	0603	ROYAL	RL0603FR-070RL
2	R5,R9	100kΩ	Film Res, 1%	0603	ROYAL	RL0603FR-07100KL
0	R6	NS				
1	R7	10Ω	Film Res, 1%	0603	ROYAL	RL0603FR-0710RL
1	U1	MP2269GD	DC-DC Converter	QFN2×3	MPS	MP2269GD

## EVB TEST RESULTS

Performance waveforms are tested on the evaluation board.

V<sub>IN</sub> = 12V, V<sub>OUT</sub> = 3.3V, L = 6.5μH, F<sub>SW</sub> = 500kHz, T<sub>A</sub> = 25°C, BIAS and MODE are connected to GND, unless otherwise noted.

**Input/Output Ripple**

I<sub>OUT</sub> = 0A

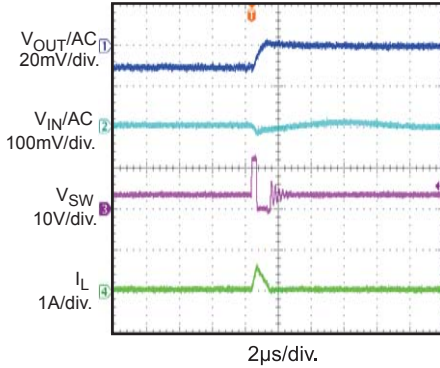

**Input/Output Ripple**

I<sub>OUT</sub> = 1A

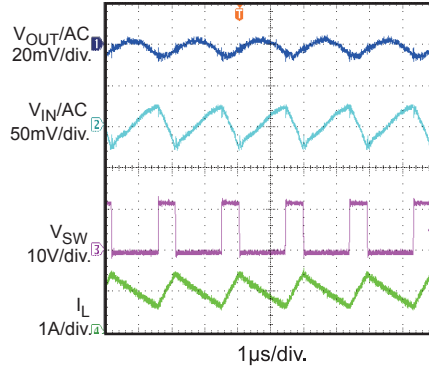

**Start-Up through Input Voltage**

I<sub>OUT</sub> = 0A

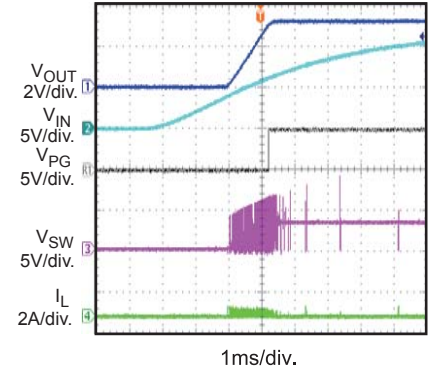

**Start-Up through Input Voltage**

I<sub>OUT</sub> = 1A

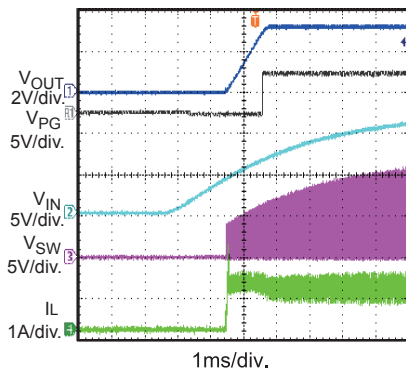

**Shutdown through Input Voltage**

I<sub>OUT</sub> = 0A

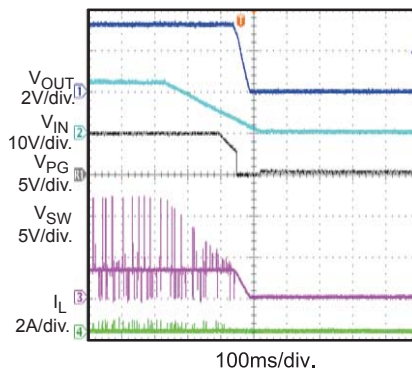

**Shutdown through Input Voltage**

I<sub>OUT</sub> = 1A

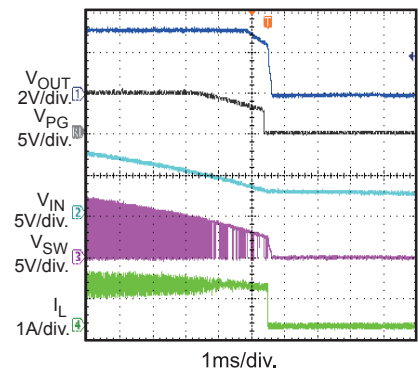

**Start-Up through EN**

I<sub>OUT</sub> = 0A

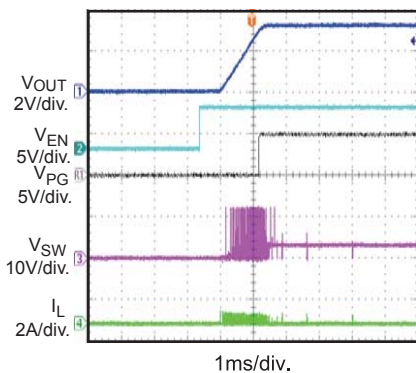

**Start-Up through EN**

I<sub>OUT</sub> = 1A

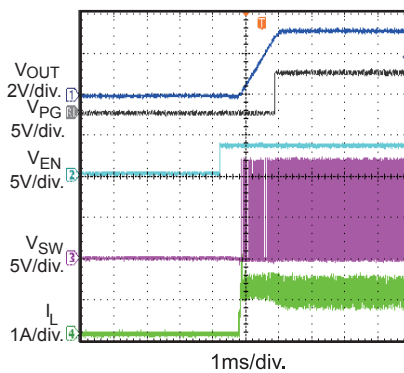

**Shutdown through EN**

I<sub>OUT</sub> = 0A

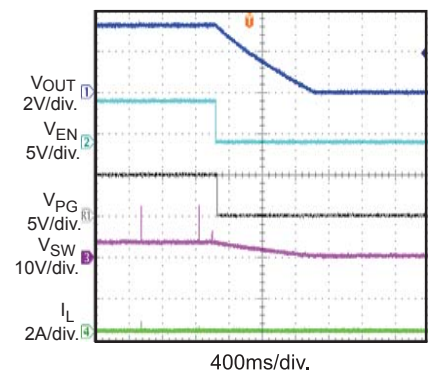

**EVB TEST RESULTS (continued)**

Performance waveforms are tested on the evaluation board.

**V<sub>IN</sub> = 12V, V<sub>OUT</sub> = 3.3V, L=6.5μH, F<sub>SW</sub>=500kHz, T<sub>A</sub> = 25°C, BIAS and MODE are connected to GND, unless otherwise noted.**
**Shutdown through EN**

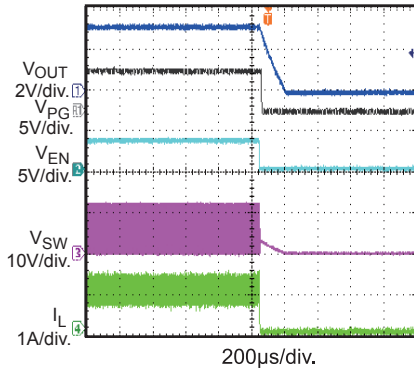
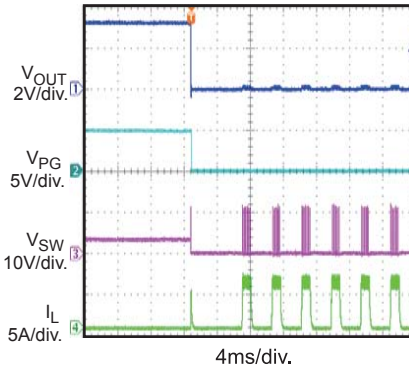
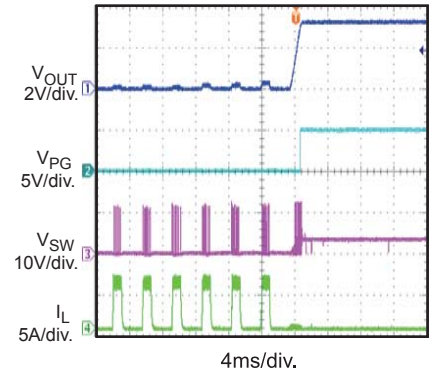
 I<sub>OUT</sub> = 1A

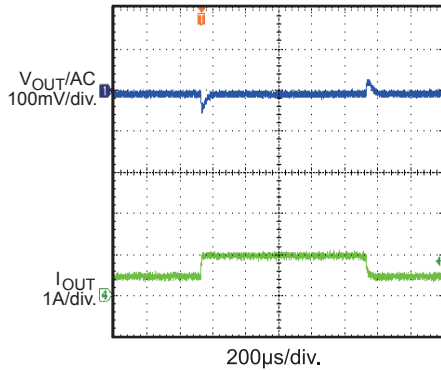
**Short Circuit Protection Entry**

**Short Circuit Protection Recovery**

**Load Transient Response**

 I<sub>OUT</sub> = 0.5A to 1A

## PRINTED CIRCUIT BOARD LAYOUT

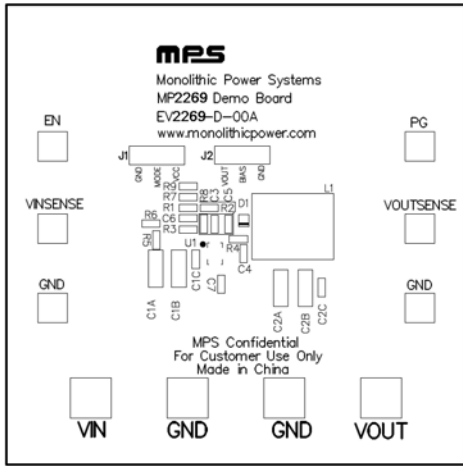

Figure 1: Top Silk Layer

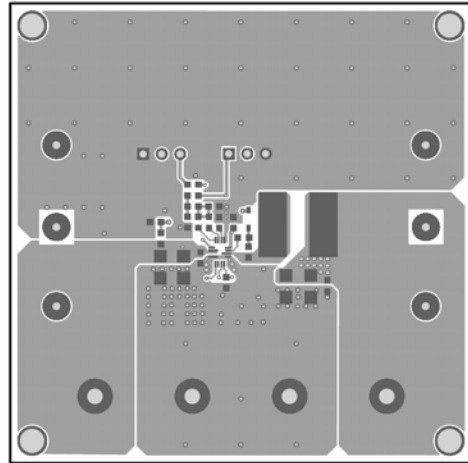

Figure 2: Top Layer

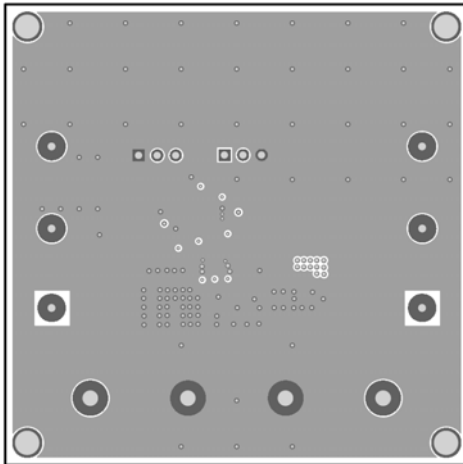

Figure 3: Inner1 Layer

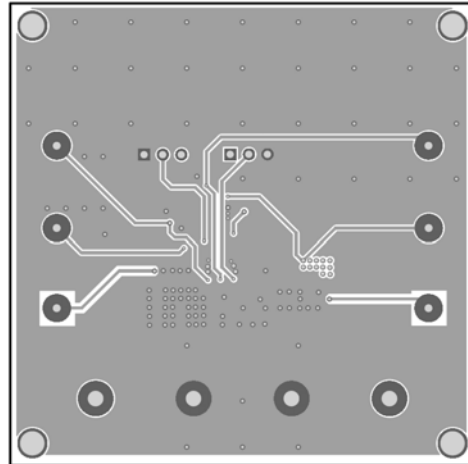

Figure 4: Inner2 Layer

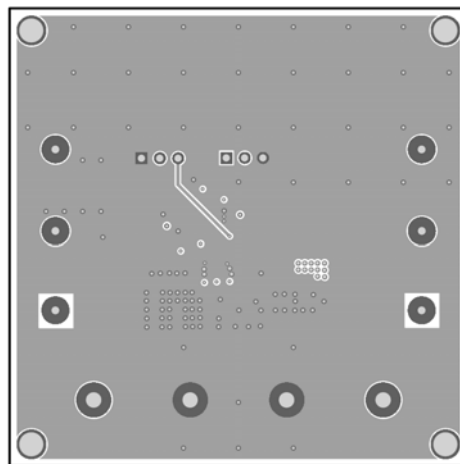

Figure 5: Bottom Layer

## QUICK START GUIDE

1. Connect the positive and negative terminals of the load to the VOUT and GND pins respectively.
2. Preset the output of power supply 12V, and then turn off the power supply.
3. Connect the positive and negative terminals of the power supply output to the VIN and GND pins respectively:
4. Turn the power supply on. The MP2269GD will automatically start up.
5. To use the Enable function, apply a digital input to the EN pin. Drive EN high to turn on the regulator or low to turn it off
6. Use R1 and R2 to set the output voltage. Follow the Application information section in the device datasheet to select the proper value of R1, R2, inductor and output capacitor values when output voltage is changed.

**NOTICE:** The information in this document is subject to change without notice. Please contact MPS for current specifications. Users should warrant and guarantee that third party Intellectual Property rights are not infringed upon when integrating MPS products into any application. MPS will not assume any legal responsibility for any said applications.