



The Future of Analog IC Technology®

EV2143H-D-00A

3A, 5.5V, 2MHz Synchronous Step-Down Switcher Evaluation Board

DESCRIPTION

The EV2143H-D-00A is used for demonstrating the performance of MPS's MP2143H, a monolithic, step-down, switch-mode converter with internal power MOSFETs. It can achieve up to 3A continuous output current from a 2.5V-to-5.5V input voltage with excellent load and line regulation. The output voltage can be regulated as low as 0.6V.

Constant-on-time control provides fast transient response and eases loop stabilization. Fault condition protections include cycle-by-cycle current limiting and thermal shutdown.

MP2143H is ideal for wide range of applications including high-performance DSPs, FPGAs, portable instruments, and automotive power systems.

MP2143H is available in QFN10 package.

EV2143H-D-00A contains two different layouts, a tiny one and a normal one. They will work with different thermal performances.

ELECTRICAL SPECIFICATION

Parameter	Symbol	Value	Units
Input Voltage ⁽¹⁾	V _{IN}	2.5– 5.5	V
Output Voltage	V _{OUT}	1.2	V
Output Current	I _{OUT}	3	A

NOTE 1: More input capacitors may be needed when V_{IN} is lower than 3.5V

FEATURES

- Wide 2.5V-to-5.5V Operating Input Range
- Output Voltage as Low as 0.6V
- 100% Duty Cycle in Dropout
- Up to 3A Output Current
- 80mΩ and 40mΩ Internal Power MOSFET Switches
- Default 2.0MHz Switching Frequency
- EN and Power-Good for Power Sequencing
- Cycle-by-Cycle Over-Current Protection
- Auto Discharge at Power Off
- Short-Circuit Protect with Hiccup Mode
- Stable with Low-ESR Output Ceramic Capacitors
- Available in QFN-10 (2mmx3mm) Package

APPLICATIONS

- Low Voltage I/O System Power
- Handheld/Battery-powered Systems
- Wireless/Networking Cards

All MPS parts are lead-free, halogen free, and adhere to the RoHS directive. For MPS green status, please visit MPS website under Quality Assurance.

"MPS" and "The Future of Analog IC Technology" are Registered Trademarks of Monolithic Power Systems, Inc.

EV2143H-D-00A EVALUATION BOARD



Board Number	MPS IC Number
EV2143H-D-00A	MP2143HGD

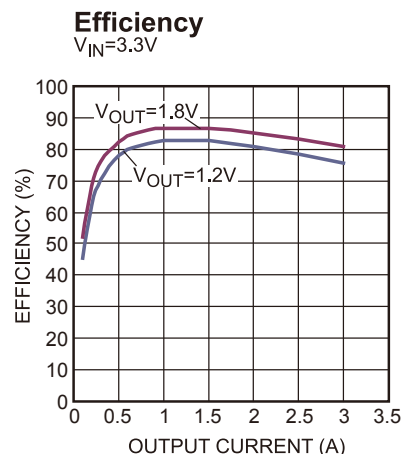

EVALUATION BOARD SCHEMATIC

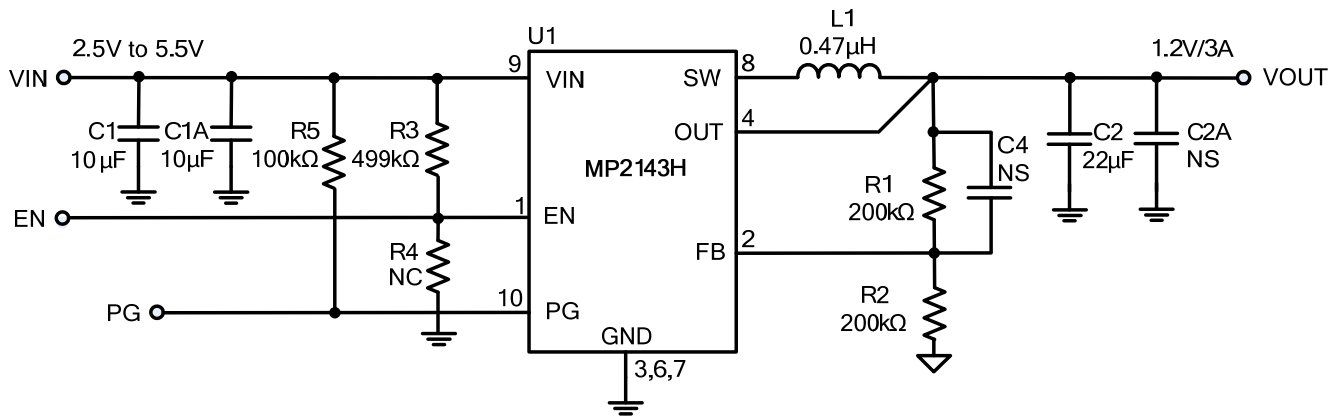

Tiny Layout

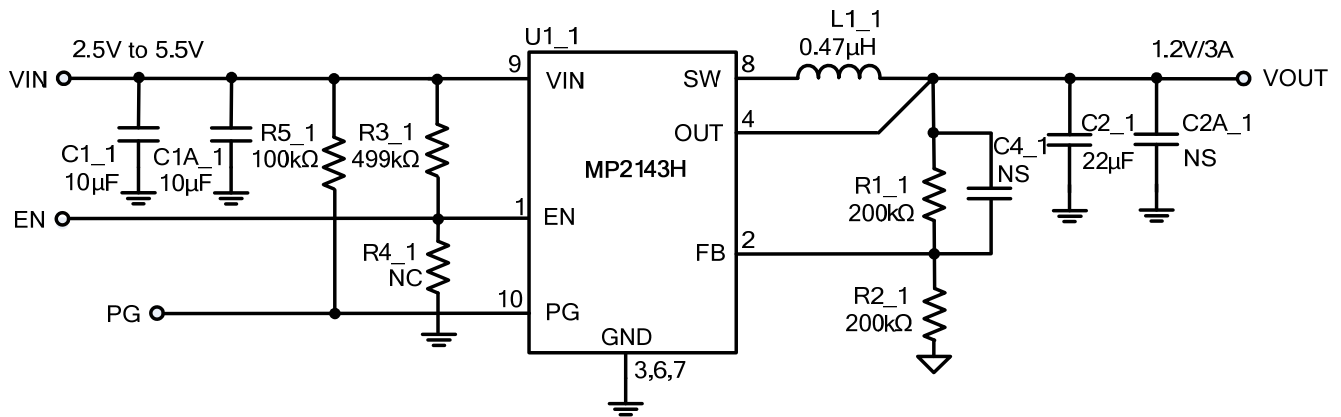

Normal Layout

EV2143H-J-00A BILL OF MATERIALS

Qty	RefDes	Value	Description	Package	Manufacturer	Manufacturer P/N
2	C1,C1A	10µF	Ceramic Cap, 10V,X5R	0805	muRata	GRM21BR61A106KE19L
1	C2	22µF	Ceramic Cap, 10V,X5R	0805	muRata	GRM21BR61A226ME51L
2	L1,L1_1	0.47µH	Inductor, 6.8A, 14mΩ	4mmx2mm	Würth	744 373 240 047
2	R1,R2	200k	Film Res.,1%	0402	Any	
1	R3	499k	Film Res.,5%	0402	Any	
1	R5	100k	Film Res.,5%	0402	Any	
0	C2A,C3, C2A_1,C3_1	NS				
0	R4,R4_1	NS				
2	U1,U1_1	MP2143H	Synchronous Step-Down switcher	QFN10 2mmx3mm	MPS	MP2143HGD
2	C1_1,C1A_1	10µF	Ceramic Cap,10V,X7R	1206	muRata	GRM31CR71A106KA01L
1	C2_1	22µF	Ceramic Cap,6.3V,X5R	1206	muRata	GRM31CR60J226KE19
2	R1_1,R2_1	200k	Film Res,1%	0603	Yageo	RC0603JR-07200KL
1	R3_1	499k	Film Res,1%	0603	Yageo	RC0603JR-07499KL
1	R5_1	100k	Film Res,1%	0603	Yageo	RC0603JR-07100KL

EVB TEST RESULTS

Performance waveforms are tested on the evaluation board.

$V_{IN} = 5V$, $V_{OUT} = 1.2V$, $L = 0.47\mu H$, $C_{OUT} = 22\mu F$, $T_A = 25^\circ C$, unless otherwise noted.

Efficiency

$V_{IN} = 3.3V$

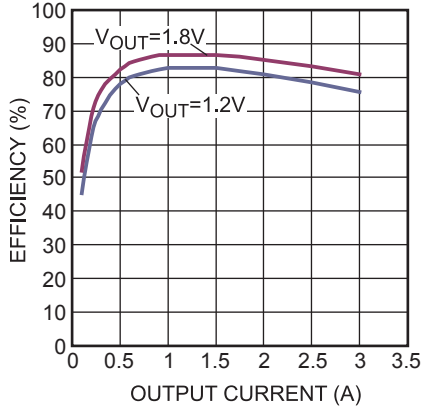

Load Regulation

$V_{IN} = 3.3V$

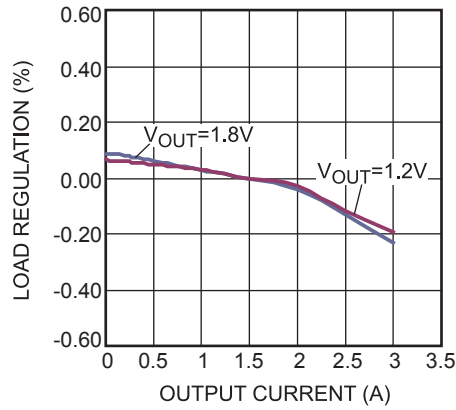

Line Regulation

$V_{IN} = 3.3V$

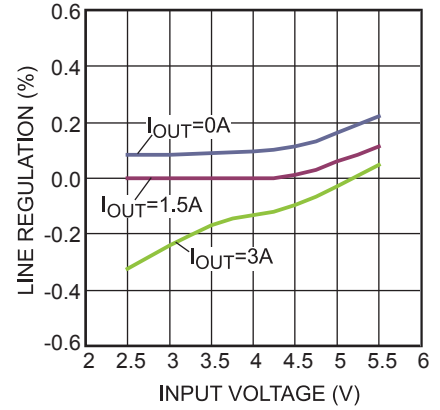

Case Temperature Rise

$V_{IN} = 3.3V$

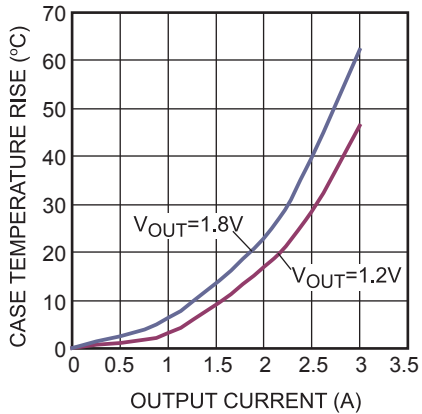

Shutdown Current vs. Input Voltage

$V_{IN} = 5V$

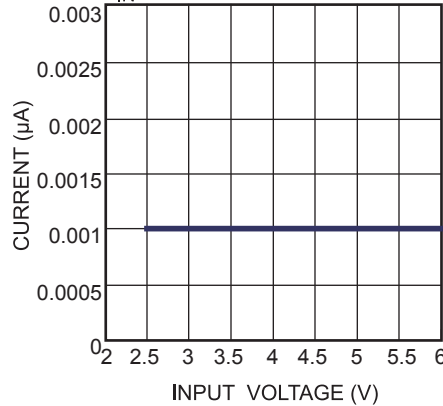

V_{IN} UVLO vs. Temperature

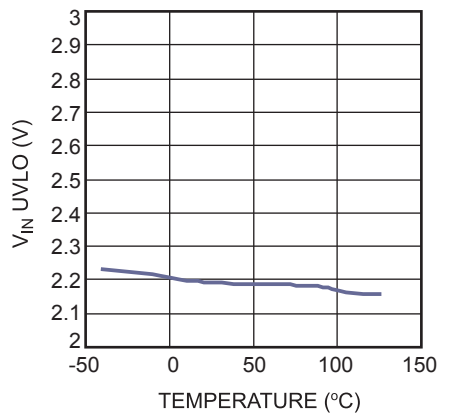

EVB TEST RESULTS (continued)

Performance waveforms are tested on the evaluation board.

$V_{IN} = 5V$, $V_{OUT} = 1.2V$, $L = 0.47\mu H$, $C_{OUT} = 22\mu F$, $T_A = 25^\circ C$, unless otherwise noted.

Output Ripple

$I_{OUT} = 0A$

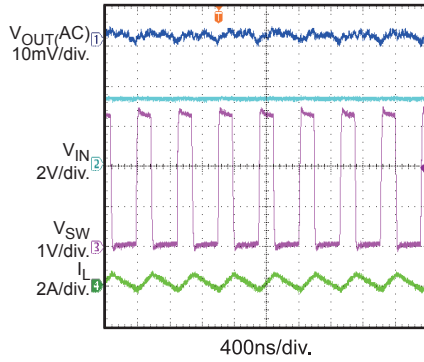

Output Ripple

$I_{OUT} = 1A$

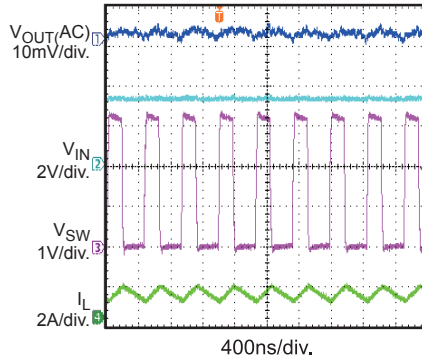

Output Ripple

$I_{OUT} = 2A$

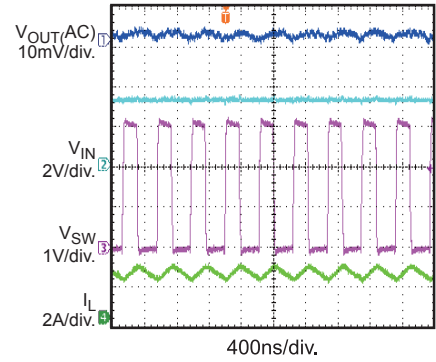

VIN Start Up without Load

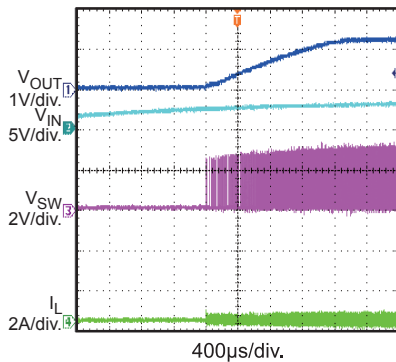

VIN Shutdown without Load

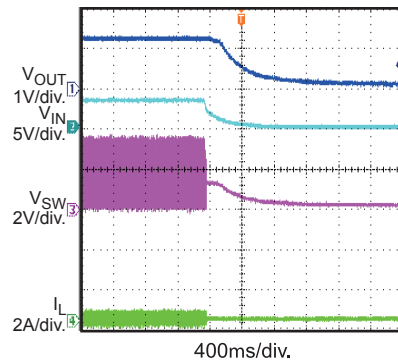

VIN Start Up with 3A Load

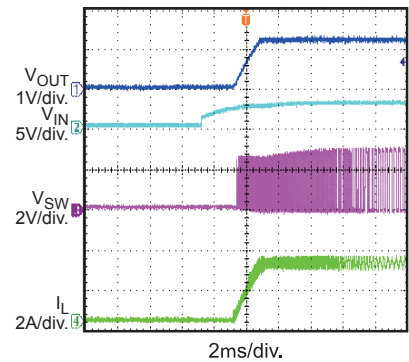

VIN Shutdown with 3A Load

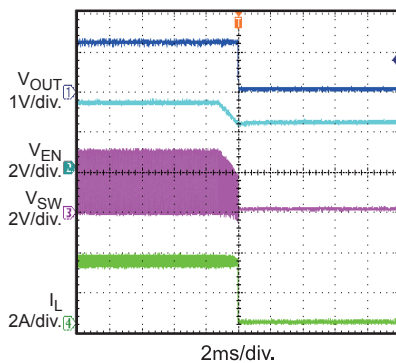

EN Start Up without Load

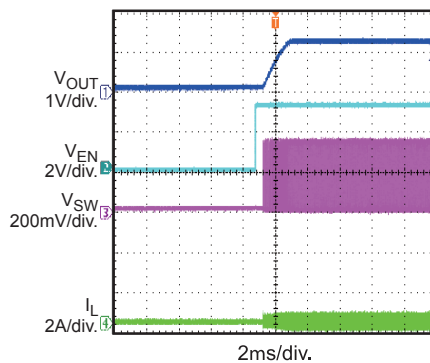

EN Shutdown without Load

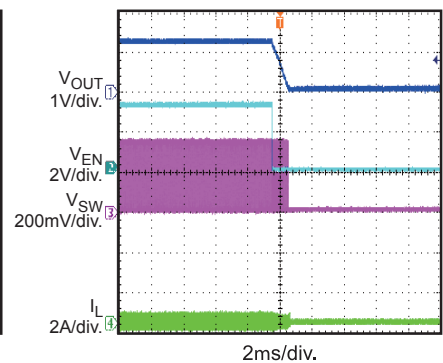

EVB TEST RESULTS *(continued)*

Performance waveforms are tested on the evaluation board.

$V_{IN} = 5V$, $V_{OUT} = 1.2V$, $L = 0.47\mu H$, $C_{OUT} = 22\mu F$, $T_A = 25^\circ C$, unless otherwise noted.

EN Start Up with 3A Load

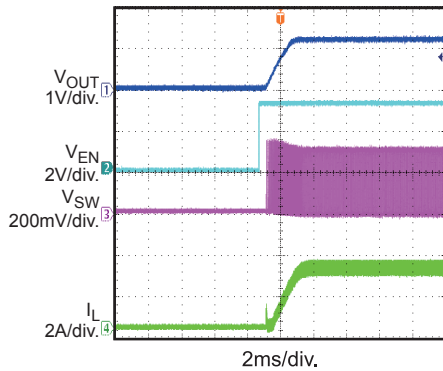

EN Shutdown with 3A Load

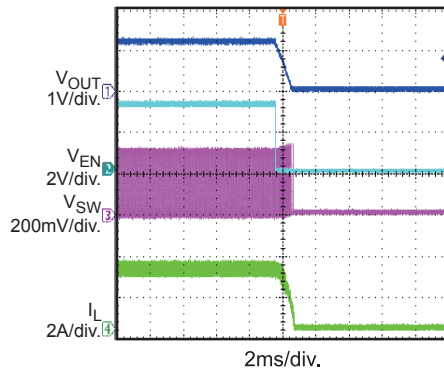

V_{IN} Start Up (PG) with 1A Load

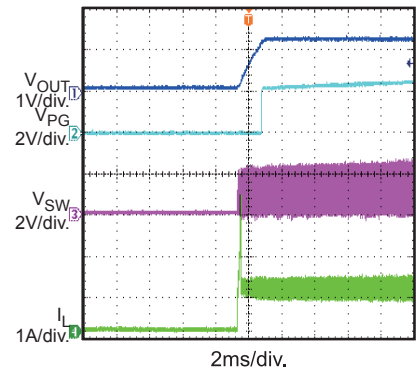

V_{IN} Shutdown (PG) with 1A Load

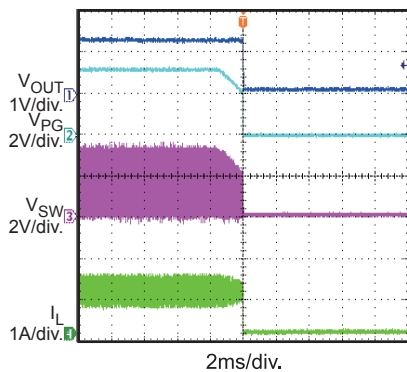

Load Transient Response

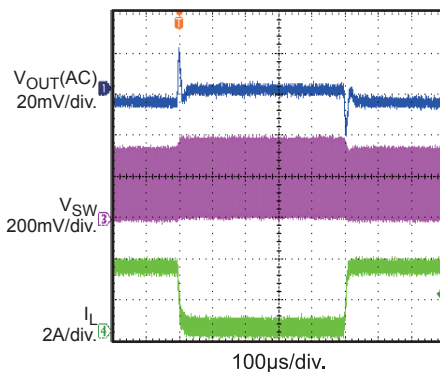

Short Circuit Entry

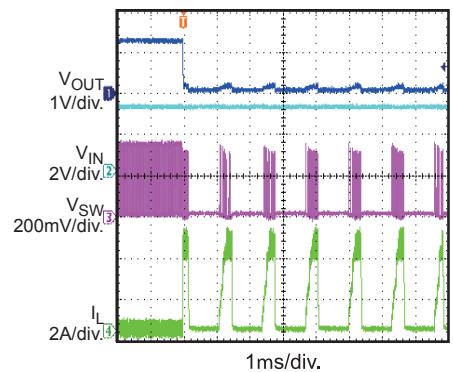

Short Circuit

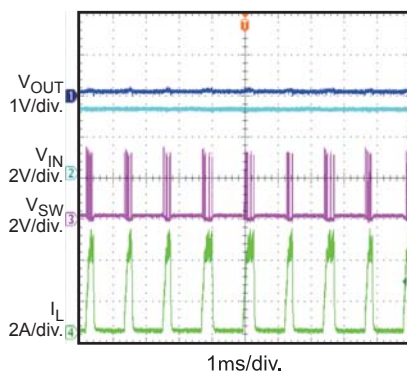

Short Circuit Recovery

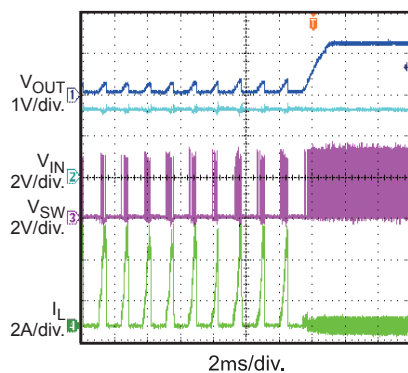

PRINTED CIRCUIT BOARD LAYOUT

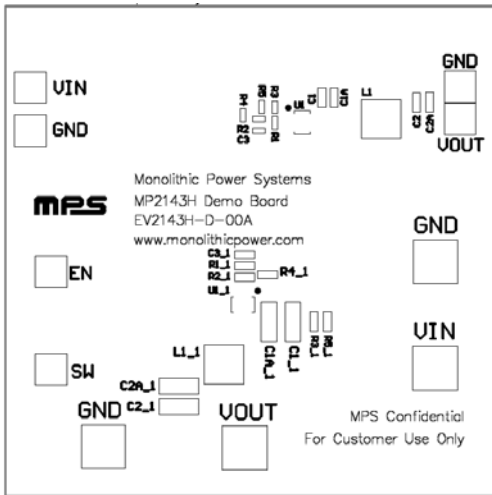

Figure 1—Top Silk Layer

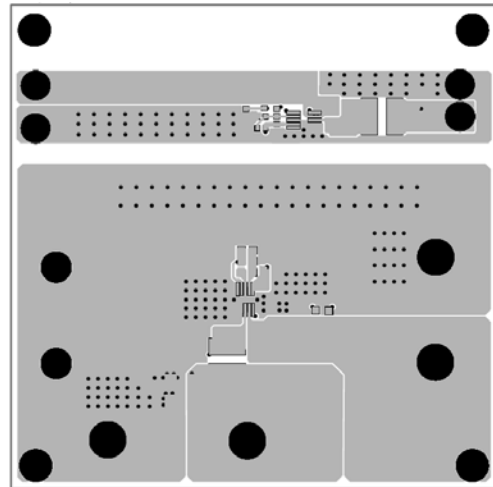

Figure 2—Top Layer

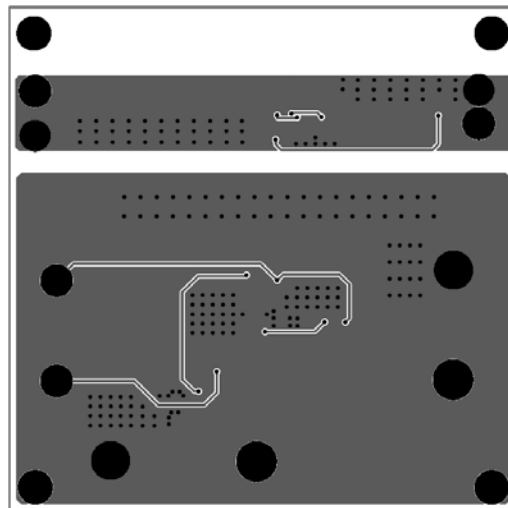

Figure 3— Bottom Layer

QUICK START GUIDE

The two layouts can also work normally after follow below steps:

1. Connect the positive and negative terminals of the load to the VOUT and GND pins, respectively.
2. Preset the power supply output between 2.5V and 5.5V, and then turn off the power supply.
3. Connect the positive and negative terminals of the power supply output to the VIN and GND pins, respectively.
4. Turn the power supply on. The board will automatically start up.
5. To use the Enable function, apply a digital input to the EN pin. Drive EN higher than 1.2V to turn on the regulator or less than 0.4V to turn it off.

LAYOUT RECOMMENDATION OF MP2143H

Proper layout of the switching power supplies is very important, and sometimes critical to make it work properly. Especially, for the high switching converter, if the layout is not carefully done, the regulator could show poor line or load regulation, stability issues.

For MP2143H, the high speed step-down regulator, the input capacitor should be placed as close as possible to the IC pins. As shown in Figure 4, the 0805 size ceramic capacitor (C1) is used, please make sure the two ends of the ceramic capacitor be directly connected to PIN9 (the Power Input Pin) and PIN6, 7 (the Power GND Pin).

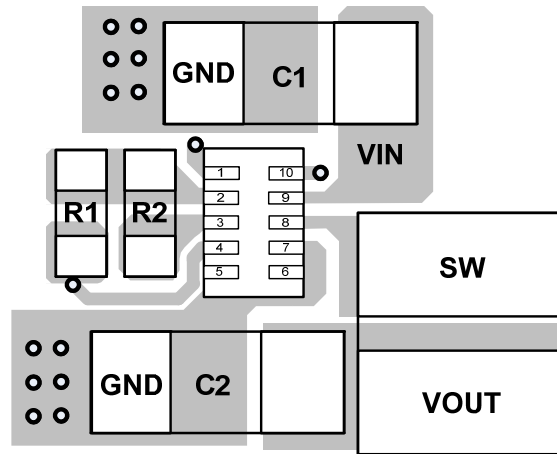

Figure 4— Two ends of Input decoupling Capacitor close to Pin 9 and Pin 6, 7

NOTICE: The information in this document is subject to change without notice. Please contact MPS for current specifications. Users should warrant and guarantee that third party Intellectual Property rights are not infringed upon when integrating MPS products into any application. MPS will not assume any legal responsibility for any said applications.