

## FEATURES

The **MSM942038-24** is part of a family of fully integrated smart motor solutions for servo motor applications. This 42mm (NEMA 17), 38W power motor integrates a brushless DC motor and driver module. The user can choose one of three options: speed control mode, position control mode, or speed/position control mode. Two control interface options are available: an RS485 interface or a PULSE/DIR interface.

Easy-to-use GUI software provides flexibility by allowing users to optimize the design online through the RS485 control interface. The parameters are saved in the motor's non-volatile memory. A design guide for the GUI is available for download at [www.monolithicpower.com](http://www.monolithicpower.com).

In addition to the fully integrated smart motor solutions, the driver modules can be ordered separately for customization into different motor types. The **MMP742038-24** is the driver module part number.

A datasheet for the MMP742038-24 is available for download at [www.monolithicpower.com](http://www.monolithicpower.com).

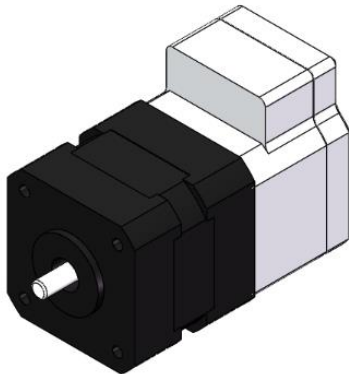

## DESCRIPTION

- 18V to 36V Input Voltage Range
- Max 38W Continuous Power Output
- 0.12N-m Rated Torque (0.36N-m Peak Torque)
- 0.3° Position Resolution
- RS485 Interface and PULSE/DIR Interface
- Position Control and Speed Control
- Operating Temperature: 0°C to 70°C (Power Derated > 40°C)
- Storage Temperature: -40°C to +125°C

## ORDERING INFORMATION

Part Number	MSM942 038-24- S-R	MSM942 038-24- P-R	MSM942 038-24- C-R	MSM942 038-24- P-D
Diameter (mm)	42	42	42	42
Power (W)	38	38	38	38
Typical Voltage (V)	24	24	24	24
Control Mode	Speed	Position	Speed/ Position	Position
Interface	RS485	RS485	RS485	PULSE/ DIR

To evaluate the smart motor, an evaluation kit can be ordered directly from [monolithicpower.com](http://monolithicpower.com).

### Evaluation Kit EVKT-942038-24

#	Part Number	Item	Quantity
1	MSM942038-24-X-X	Smart motor	1
2	eMotion System™ communication kit	USB communication interface with cable	1

**SMART MOTOR SPECIFICATIONS**

Smart Motor			
Parameters	Condition	Value	Units
Input voltage		24	V
Output power	0°C to 40°C	38	W
Position resolution		0.3	°
Nominal speed		3000	rpm
Nominal torque		0.12	N-m
Rotor inertia		24	g-cm <sup>2</sup>
Diameter		42	mm
Shaft diameter		5	mm
Length	Body only	40	mm
Weight		300	g

**RECOMMENDED OPERATION CONDITIONS**

Input voltage ..... 18V to 36V  
 Control interface voltage ..... 0V to 5.5V  
 Max pulse frequency ..... 500kHz  
 RS485 A/B voltage ..... 0V to 5.5V  
 RS485 common mode voltage ..... ±15V  
 Operation temperature ..... 0°C to 70°C  
 Storage temperature ..... -40°C to +125°C

**HARDWARE CONNECTION FOR SMART MOTOR**

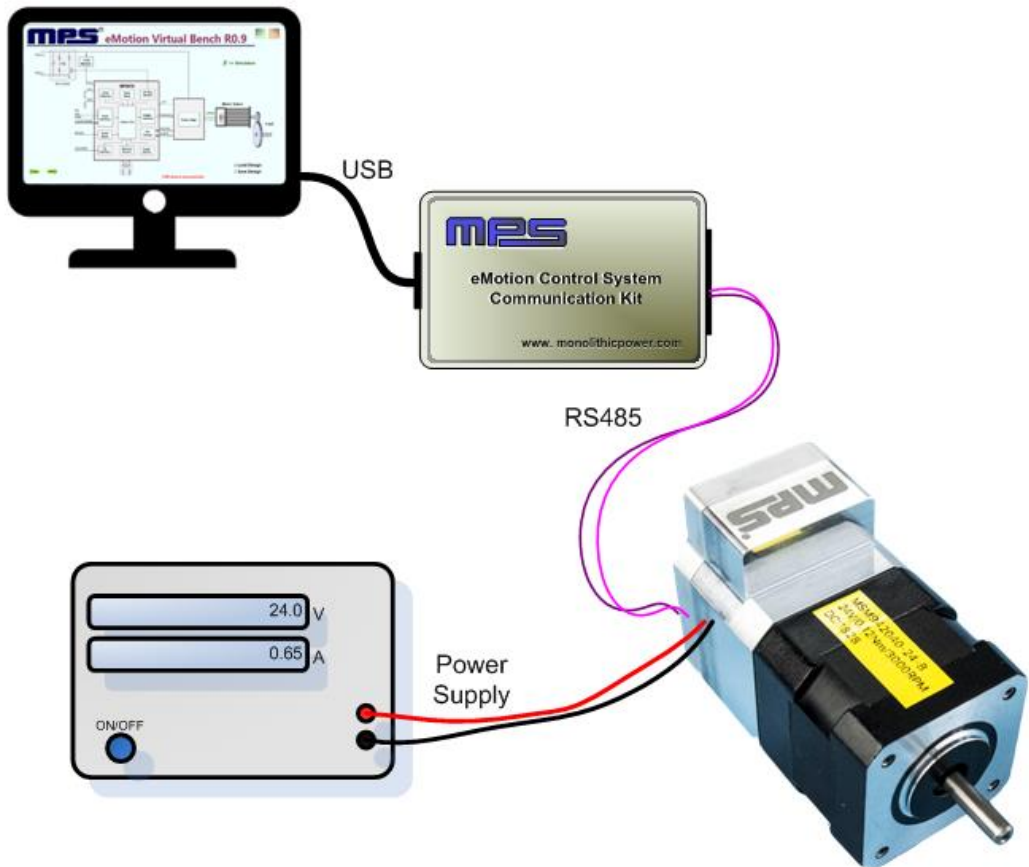

## PIN CONFIGURATION

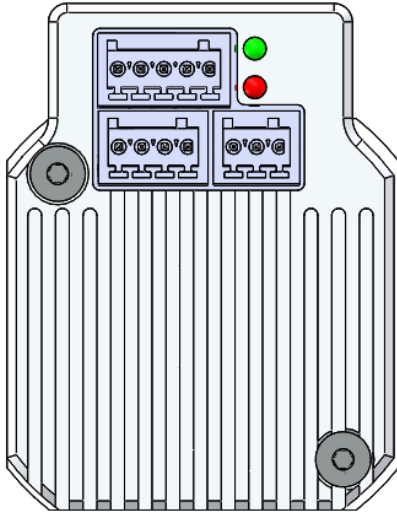
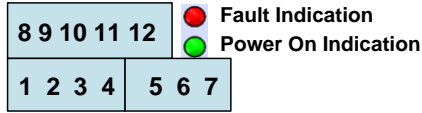

Pin Number	Designation	Pin Description
<b>RS485 Interface</b>		
1	EXT_5V	5V input for firmware programming
2	B	RS485 node B
3	AGND	RS485 ground
4	A	RS485 node A
<b>Power Interface</b>		
5	GND	Power ground
6	R-	Shunt resistor return node
7	VIN	Input power supply
<b>Control Interface</b>		
8	COM-	Common return
9	EN+	Enable input
10	PEND+	Position end output
11	PUL+	Pulse input
12	DIR+	Direction input

## TYPICAL PERFORMANCE CHARACTERISTICS

$T_A = 25^\circ\text{C}$ ,  $V_{IN} = 24\text{V}$ , unless otherwise noted.

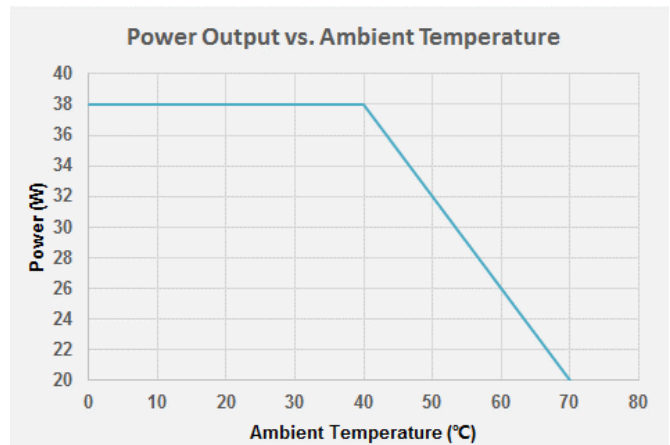
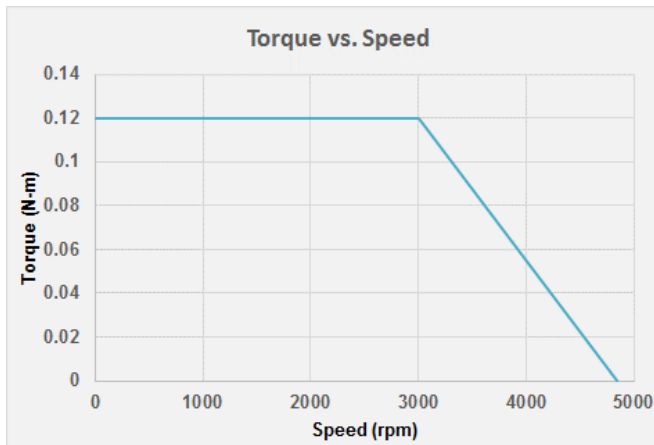

**SMART MOTOR MECHANICAL DRAWING**

