

DESCRIPTION

The MP8775 is a monolithic high frequency synchronous rectified step-down switch mode converter with built in internal power MOSFETs. It offers a very compact solution to achieve more than 5A output current over a wide input supply range with excellent load and line regulation. The integrated low side FET achieves 19mΩ for high efficiency. The MP8775 operates at high efficiency over a wide output current load range.

Current mode operation provides fast transient response and eases loop stabilization. The device also uses proprietary AAM operation for high efficiency.

Full protection features include OCP and thermal shut down.

The MP8775 is available in space saving 3mm x 4mm 14-pin QFN and 8 pin SOIC with exposed pad packages.

FEATURES

- Wide 4.5 to 23V Operating Input Range
- 5A Output Current
- 19mΩ LS FET
- Proprietary Switching Loss Reduction Technique
- Fixed 500kHz Switching Frequency
- Internal Compensation
- OCP Protection and Thermal Shutdown
- Output Adjustable from 0.8V
- Available in 14-pin QFN3x4 and SOIC8E packages

APPLICATIONS

- Notebook Systems and I/O Power
- Networking Systems
- Digital Set Top Boxes
- Personal Video Recorders
- Flat Panel Television and Monitors
- Distributed Power Systems

"MPS" and "The Future of Analog IC Technology" are Registered Trademarks of Monolithic Power Systems, Inc.

The information in this datasheet about the product and its associated technologies are proprietary and intellectual property of Monolithic Power Systems and are protected by copyright and pending patent applications.

TYPICAL APPLICATION

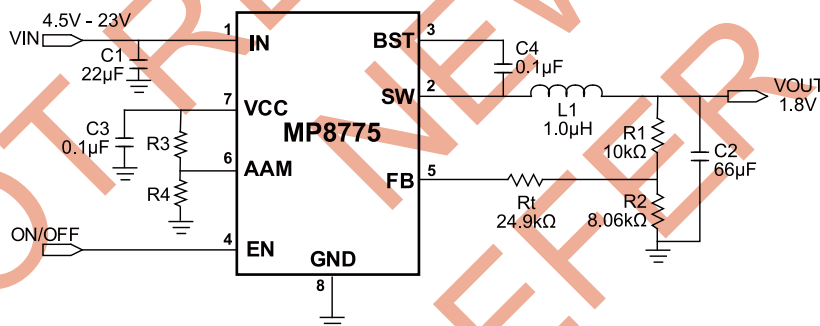

Efficiency

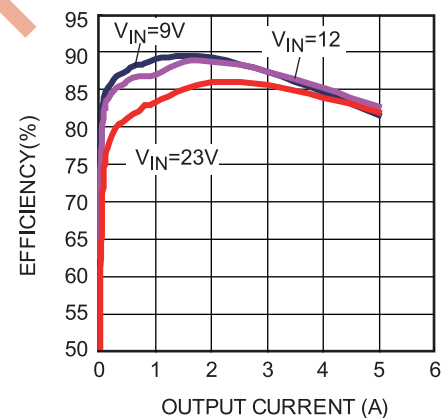

ORDERING INFORMATION

Part Number	Package	Top Marking	Free Air Temperature (T _A)
MP8775EL*	3x4 QFN14	8775	-20°C to +85°C
MP8775EN**	SOIC8E	MP8775EN	-20°C to +85°C

* For Tape & Reel, add suffix -Z (e.g. MP8775EL-Z);

For RoHS compliant packaging, add suffix -LF; (e.g. MP8775EL-LF-Z)

** For Tape & Reel, add suffix -Z (e.g. MP8775EN-Z);

For RoHS compliant packaging, add suffix -LF; (e.g. MP8775EN-LF-Z)

PACKAGE REFERENCE

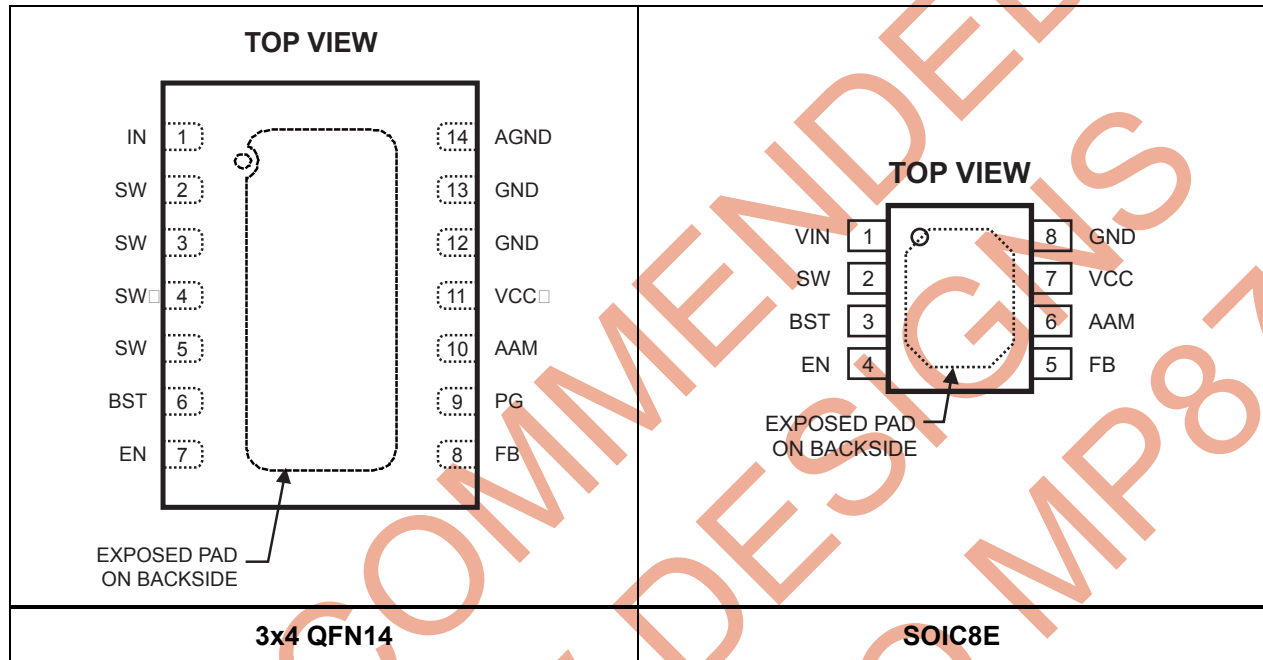

ABSOLUTE MAXIMUM RATINGS ⁽¹⁾

Supply Voltage V _{IN}	25V
V _{SW}	-0.3V (-5V for 10ns) to 25V
V _{BS}	V _{SW} + 6V
All Other Pins.....	-0.3V to +6V
Continuous Power Dissipation (T _A = +25°C) ⁽²⁾	2.6W
Junction Temperature.....	150°C
Lead Temperature.....	260°C
Storage Temperature.....	-65°C to +150°C

Recommended Operating Conditions ⁽³⁾

Supply Voltage V _{IN}	4.5V to 23V
Operating Junct. Temp (T _J).....	-20°C to +125°C

Thermal Resistance ⁽⁴⁾

	θ_{JA}	θ_{JC}
3x4 QFN14.....	48.....	11..... °C/W
SOIC8 (Exposed Pad).....	50.....	10..... °C/W

Notes:

- Exceeding these ratings may damage the device.
- The maximum allowable power dissipation is a function of the maximum junction temperature T_{J (MAX)}, the junction-to-ambient thermal resistance θ_{JA} , and the ambient temperature T_A. The maximum allowable continuous power dissipation at any ambient temperature is calculated by P_{D (MAX)} = (T_{J (MAX)} - T_A) / θ_{JA} . Exceeding the maximum allowable power dissipation will cause excessive die temperature, and the regulator will go into thermal shutdown. Internal thermal shutdown circuitry protects the device from permanent damage.
- The device is not guaranteed to function outside of its operating conditions.
- Measured on JESD51-7, 4-layer PCB.

ELECTRICAL CHARACTERISTICS

$V_{IN} = 12V$, $T_A = +25^{\circ}C$, unless otherwise noted.

Parameters	Symbol	Condition	Min	Typ	Max	Units
Supply Current (Shutdown)	I_{IN}	$V_{EN} = 0V$		0		μA
Supply Current (Quiescent)	I_{IN}	$V_{EN} = 2V$, $V_{FB} = 1V$		1		mA
HS Switch On Resistance ⁽⁵⁾	HS_{RDS-ON}			110		m Ω
LS Switch On Resistance ⁽⁵⁾	LS_{RDS-ON}			19		m Ω
Switch Leakage	SW_{LKG}	$V_{EN} = 0V$, $V_{SW} = 0V$ or $12V$		0	5	μA
Current Limit	I_{LIMIT}			8		A
Oscillator Frequency	F_{SW}	$V_{FB} = 0.75V$	350	500	650	kHz
Fold-back Frequency	F_{FB}	$V_{FB} = 100mV$		0.25		f _{SW}
Maximum Duty Cycle	D_{MAX}	$V_{FB} = 700mV$	85	90		%
Feedback Voltage	V_{FB}		785	805	825	mV
Feedback Current	I_{FB}	$V_{FB} = 800mV$		10	50	nA
EN Input Low Voltage	V_{IL-EN}				0.4	V
EN Input High Voltage	V_{IH-EN}		2			V
EN Input Current	I_{EN}	$V_{EN} = 2V$		2		μA
EN Input Current		$V_{EN} = 0V$		0		
EN Turn Off Delay	EN_{Td-Off}			5		μsec
Power Good Rising Threshold	PG_{Vth-Hi}			0.9		V_{FB}
Power Good Falling Threshold	PG_{Vth-Lo}			0.7		V_{FB}
Power Good Delay	PG_{Td}			250		μs
Power Good Sink Current Capability	V_{PG}	Sink 4mA			0.4	V
Power Good Leakage Current	$I_{PG-LEAK}$	$V_{PG} = 3.3V$			10	nA
V_{IN} Under Voltage Lockout Threshold Rising	$INUV_{Vth}$		3.8	4.0	4.2	V
V_{IN} Under Voltage Lockout Threshold Hysteresis	$INUV_{HYS}$			880		mV
VCC Regulator	V_{CC}			5		V
VCC Load Regulation		$I_{CC}=5mA$		5		%
Thermal Shutdown	T_{SD}			150		$^{\circ}C$

PIN FUNCTIONS

Pin # QFN14	Pin # SOIC8E	Name	Description
1	1	IN	Supply Voltage. The MP8775 operates from a +4.5V to +23V input rail. C1 is needed to decouple the input rail. Use wide PCB traces and multiple vias to make the connection.
2,3,4,5	2	SW	Switch Output. Use wide PCB traces and multiple vias to make the connection.
6	3	BST	Bootstrap. A capacitor connected between SW and BST pins is required to form a floating supply across the high-side switch driver.
7	4	EN	EN=1 to enable the MP8775.
8	5	FB	Feedback. An external resistor divider from the output to GND, tapped to the FB pin, sets the output voltage. To prevent current limit run away during a short circuit fault condition the frequency fold-back comparator lowers the oscillator frequency when the FB voltage is below 200mV.
9	--	PG	Power Good Output, the output of this pin is open drain. Power good threshold is 90% low to high with typical 250 μ s delay and 70% high to low of regulation value.
10	6	AAM	Connects to a voltage set by 2 resistor dividers forces MP8775 into non-synchronous mode when load is small.
11	7	VCC	Bias Supply. Decouple with 0.1 μ F capacitor.
12,13	8	GND	System Ground. This pin is the reference ground of the regulated output voltage. For this reason care must be taken in PCB layout.
14	--	AGND	Ground. Connect these pins with larger copper areas to the negative terminals of the input and output capacitors. Connect exposed pad to GND plane for proper thermal performance.

TYPICAL PERFORMANCE CHARACTERISTICS

$V_{IN}=12V$, $V_{OUT}=1.8V$, $L=1.0\mu H$, $T_A=+25^\circ C$, unless otherwise noted.

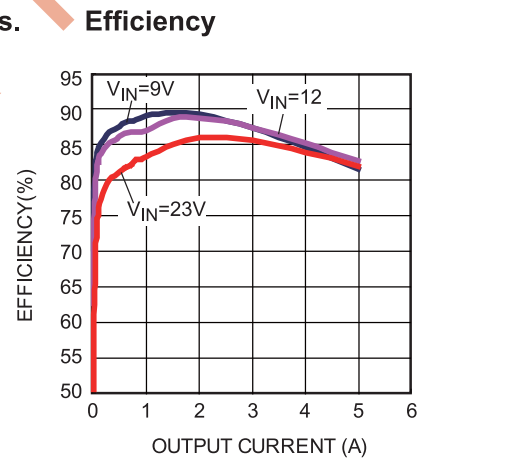
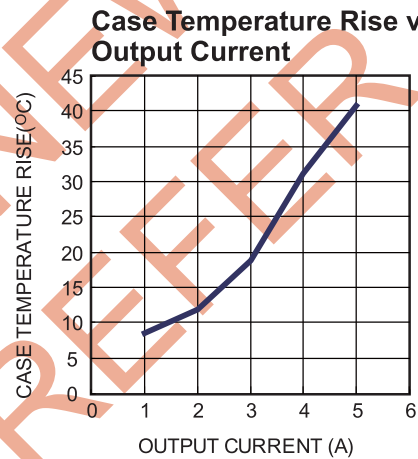
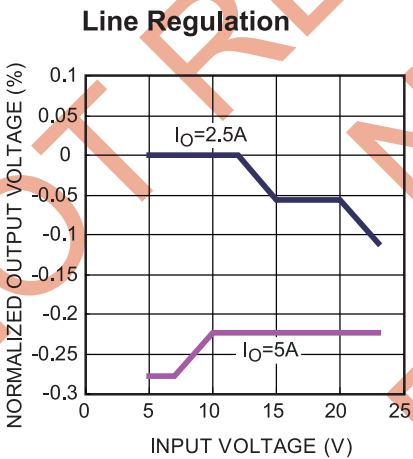
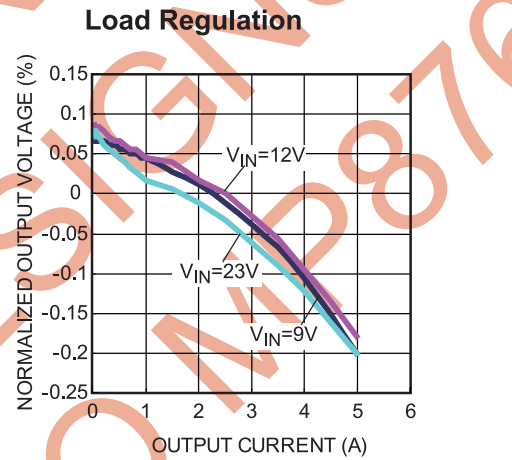
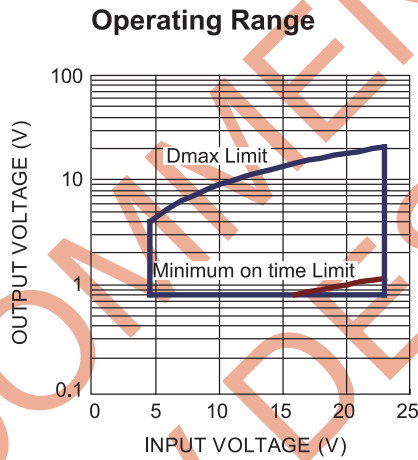
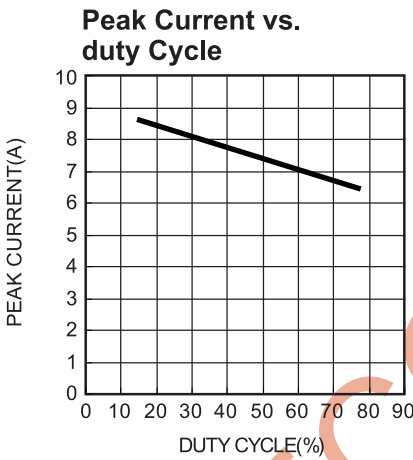
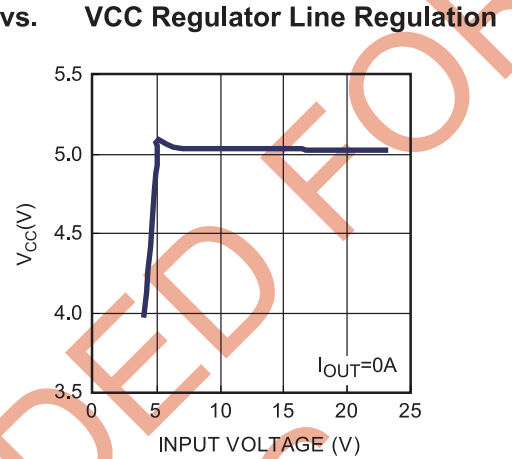
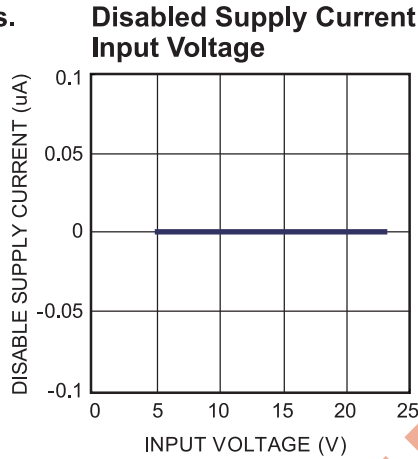
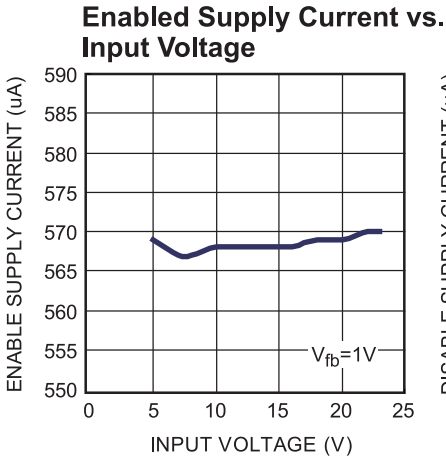

TYPICAL PERFORMANCE CHARACTERISTICS (continued)
 $V_{IN}=12V$, $V_{OUT}=1.8V$, $L=1.0\mu H$, $T_A=+25^\circ C$, unless otherwise noted.

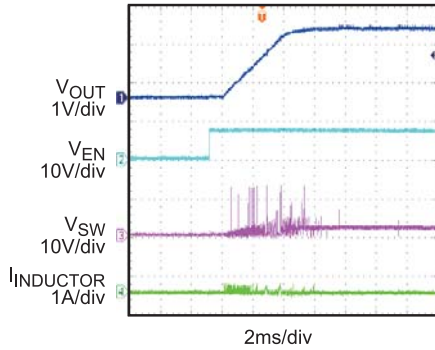
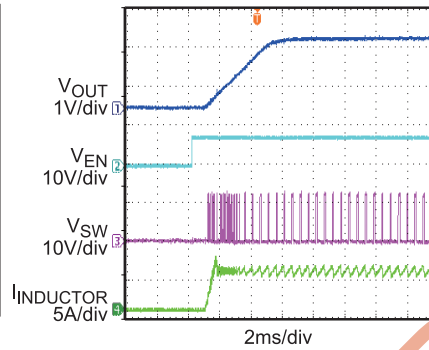
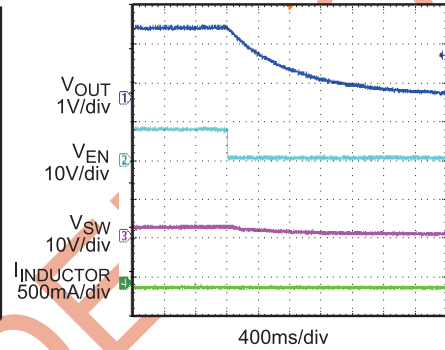
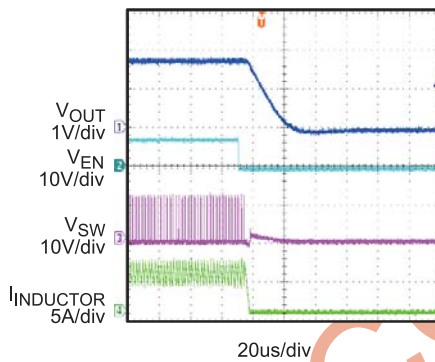
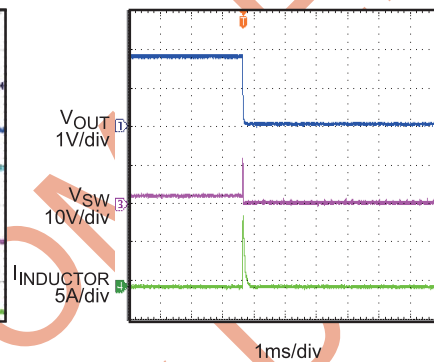
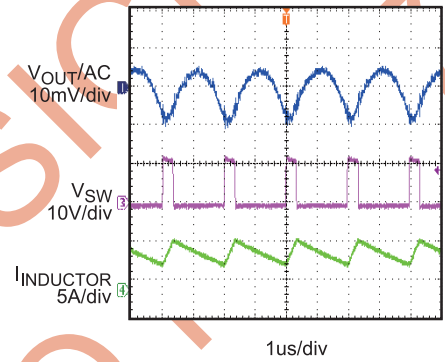
Enable Startup
 $I_{OUT}=0A$

Enable Startup
 $I_{OUT}=5A$

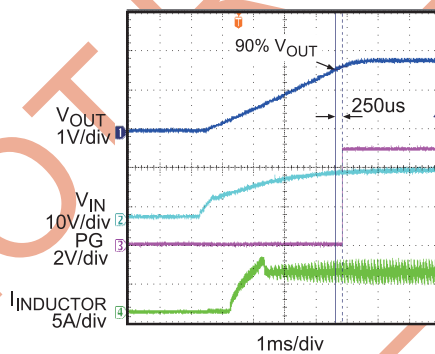
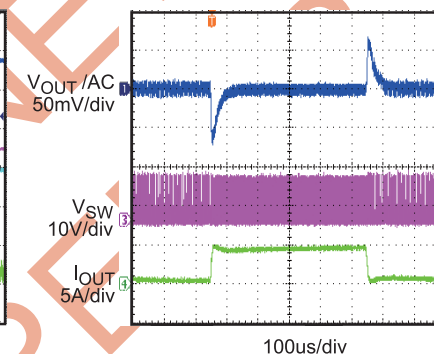
Enable Shut Down
 $I_{OUT}=0A$

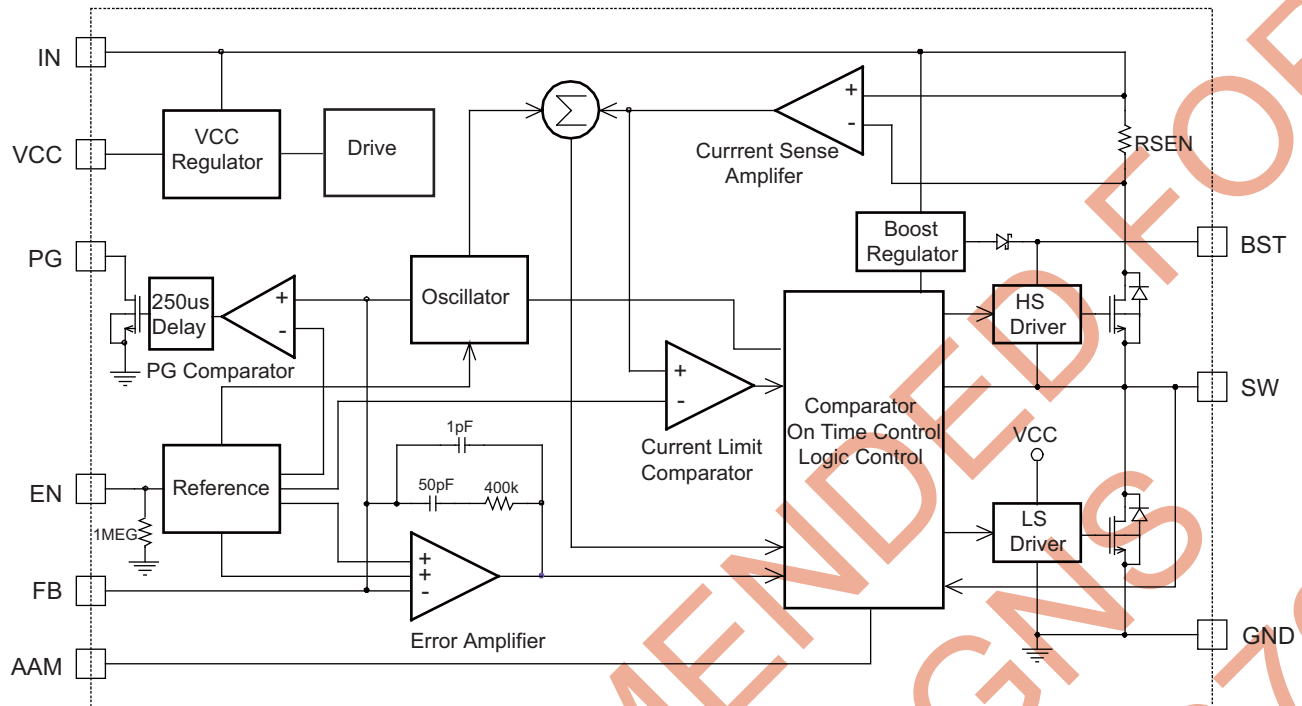
Enable Shut Down
 $I_{OUT}=5A$

Short Circuit Protection

Output Ripple Voltage
 $I_{OUT}=5A$

PG Delay @ Start up

250us delay

Load Transient Response
 $I_{OUT}=0.5A-4.5A @ 2.5A/us$

BLOCK DIAGRAM

Figure 1—Functional Block Diagram

OPERATION

The MP8775 is a high frequency synchronous rectified step-down switch mode converter with built in internal power MOSFETs. It offers a very compact solution to achieve more than 5A continuous output current over a wide input supply range with excellent load and line regulation.

The MP8775 operates in a fixed frequency, peak current control mode to regulate the output voltage. A PWM cycle is initiated by the internal clock. The integrated high-side power MOSFET is turned on and remains on until its current reaches the value set by the COMP voltage. When the power switch is off, it remains off until the next clock cycle starts. If, in 90% of one PWM period, the current in the power MOSFET does not reach the COMP set current value, the power MOSFET will be forced to turn off.

Error Amplifier

The error amplifier compares the FB pin voltage with the internal 0.8V reference (REF) and outputs a current proportional to the difference between the two. This output current is then used to charge or discharge the internal compensation network to form the COMP voltage, which is used to control the power MOSFET current. The optimized internal compensation network minimizes the external component counts and simplifies the control loop design.

Internal Regulator

Most of the internal circuitries are powered from the 5V internal regulator. This regulator takes the VIN input and operates in the full VIN range. When VIN is greater than 5.0V, the output of the regulator is in full regulation. When VIN is lower than 5.0V, the output decreases, a 0.1 μ F ceramic capacitor for decoupling purpose is required.

Enable

The MP8775 has a dedicated Enable pin (EN). By pulling it high or low, the IC can be enabled and disabled by EN. Tie EN to VIN through a resistor for automatic start up. To disable the part, EN must be pulled low for at least 5 μ s.

Under-Voltage Lockout (UVLO)

Under-voltage lockout (UVLO) is implemented to protect the chip from operating at insufficient supply voltage. The MP8775 UVLO comparator monitors the output voltage of the internal regulator, VCC. The UVLO rising threshold is about 4.0V while its falling threshold is a consistent 3.2V.

Internal Soft-Start

The soft-start is implemented to prevent the converter output voltage from overshooting during startup. When the chip starts, the internal circuitry generates a soft-start voltage (SS) ramping up from 0V to 1.2V. When it is lower than the internal reference (REF), SS overrides REF so the error amplifier uses SS as the reference. When SS is higher than REF, REF regains control.

Over-Current-Protection and Latch off

The MP8775 has cycle-by-cycle over current limit when the inductor current peak value exceeds the set current limit threshold.

When output voltage drops below 70% of the reference, and inductor current exceeds the current limit at the meantime, MP8775 will be latched off. This is especially useful to ensure system safety under fault condition. The MP8775 clears the latch once the EN or input power is recycled.

The latch-off function is disabled during soft-start duration.

Thermal Shutdown

Thermal shutdown is implemented to prevent the chip from operating at exceedingly high temperatures. When the silicon die temperature is higher than 150°C, it shuts down the whole chip. When the temperature is lower than its lower threshold, typically 140°C, the chip is enabled again.

Floating Driver and Bootstrap Charging

The floating power MOSFET driver is powered by an external bootstrap capacitor. This floating driver has its own UVLO protection. This UVLO's rising threshold is 2.2V with a hysteresis of 150mV. The bootstrap capacitor voltage is regulated internally by V_{IN} through D1, M1, C4, L1 and C2 (Figure 2). If $(V_{IN}-V_{SW})$ is more than 5V, U1 will regulate M1 to maintain a 5V BST voltage across C4.

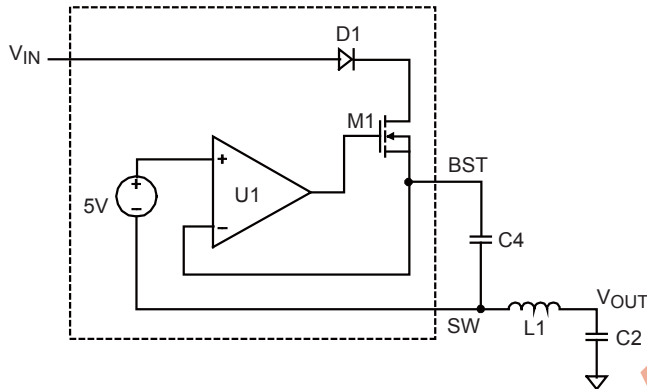

Figure 2—Internal Bootstrap Charging Circuit

Startup and Shutdown

If both V_{IN} and EN are higher than their appropriate thresholds, the chip starts. The reference block starts first, generating stable reference voltage and currents, and then the internal regulator is enabled. The regulator provides stable supply for the remaining circuitries.

Three events can shut down the chip: EN low, V_{IN} low and thermal shutdown. In the shutdown procedure, the signaling path is first blocked to avoid any fault triggering. The COMP voltage and the internal supply rail are then pulled down. The floating driver is not subject to this shutdown command.

APPLICATION INFORMATION

Setting the Output Voltage

The external resistor divider is used to set the output voltage (see Typical Application on page 1). The feedback resistor R1 also sets the feedback loop bandwidth with the internal compensation capacitor (see Typical Application on page 1). Choose R1 to be around 10kΩ for optimal transient response. R2 is then given by:

$$R2 = \frac{R1}{\frac{V_{OUT}}{0.8V} - 1}$$

The T-type network is highly recommended, as Figure 3 shows.

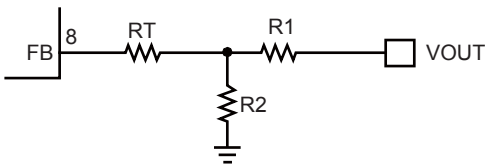

Figure 3— T-type Network

Table 1 lists the recommended T-type resistors value for common output voltages.

Table 1—Resistor Selection for Common Output Voltages

V _{OUT} (V)	R1 (kΩ)	R2 (kΩ)	Rt (kΩ)
1.05	3.09(1%)	10(1%)	24.9(1%)
1.2	4.99(1%)	10(1%)	24.9(1%)
1.8	10(1%)	8.06(1%)	24.9(1%)
2.5	10(1%)	4.75(1%)	24.9(1%)
3.3	10(1%)	3.16(1%)	24.9(1%)
5	10(1%)	1.91(1%)	24.9(1%)

Selecting the Inductor

A 1μH to 10μH inductor with a DC current rating of at least 25% percent higher than the maximum load current is recommended for most applications. For highest efficiency, the inductor DC resistance should be less than 15mΩ. For most designs, the inductance value can be derived from the following equation.

$$L_1 = \frac{V_{OUT} \times (V_{IN} - V_{OUT})}{V_{IN} \times \Delta I_L \times f_{OSC}}$$

Where ΔI_L is the inductor ripple current.

Choose inductor current to be approximately 30% of the maximum load current. The maximum inductor peak current is:

$$I_{L(MAX)} = I_{LOAD} + \frac{\Delta I_L}{2}$$

Under light load conditions below 100mA, larger inductance is recommended for improved efficiency.

Setting the AAM Voltage

The AAM voltage is used to setting the transition point from AAM to CCM. It should be chosen to provide the best combination of efficiency, stability, ripple, and transient.

If the AAM voltage is set lower, then stability and ripple improves, but efficiency during AAM mode and transient degrades. Likewise, if the AAM voltage is set higher, then the efficiency during AAM and transient improves, but stability and ripple degrades. So the optimal balance point of AAM voltage for good efficiency, stability, ripple and transient should be found out.

As figure 4 show, AAM voltage can get from V_{CC} (5V) pin by using a resistor divider.

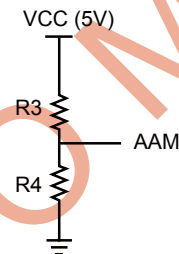

Figure 4— AAM Network

The optimized AAM can be got from Figure 5. Generally, choose R4 to be around 10 kΩ, R3 is then given by:

$$R3 = R4 \left(\frac{V_{CC}}{AAM} - 1 \right)$$

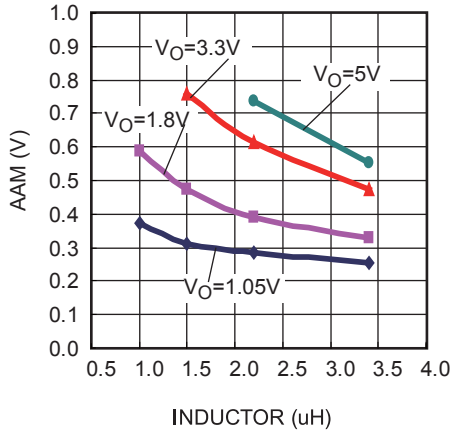

Figure 5— AAM Selection for Common Output Voltages (V_{IN}=7V-23V)

Selecting the Input Capacitor

The input current to the step-down converter is discontinuous, therefore a capacitor is required to supply the AC current to the step-down converter while maintaining the DC input voltage. Use low ESR capacitors for the best performance. Ceramic capacitors with X5R or X7R dielectrics are highly recommended because of their low ESR and small temperature coefficients. For most applications, a 22μF capacitor is sufficient.

Since the input capacitor (C1) absorbs the input switching current it requires an adequate ripple current rating. The RMS current in the input capacitor can be estimated by:

$$I_{C1} = I_{LOAD} \times \sqrt{\frac{V_{OUT}}{V_{IN}} \times \left(1 - \frac{V_{OUT}}{V_{IN}}\right)}$$

The worst case condition occurs at V_{IN} = 2V_{OUT}, where:

$$I_{C1} = \frac{I_{LOAD}}{2}$$

For simplification, choose the input capacitor whose RMS current rating greater than half of the maximum load current.

The input capacitor can be electrolytic, tantalum or ceramic. When using electrolytic or tantalum capacitors, a small, high quality ceramic capacitor, i.e. 0.1μF, should be placed as close to the IC as possible. When using ceramic capacitors, make sure that they have enough capacitance to provide sufficient charge to prevent excessive voltage ripple at input. The

input voltage ripple caused by capacitance can be estimated by:

$$\Delta V_{IN} = \frac{I_{LOAD}}{f_s \times C1} \times \frac{V_{OUT}}{V_{IN}} \times \left(1 - \frac{V_{OUT}}{V_{IN}}\right)$$

Selecting the Output Capacitor

The output capacitor (C2) is required to maintain the DC output voltage. Ceramic, tantalum, or low ESR electrolytic capacitors are recommended. Low ESR capacitors are preferred to keep the output voltage ripple low. The output voltage ripple can be estimated by:

$$\Delta V_{OUT} = \frac{V_{OUT}}{f_s \times L_1} \times \left(1 - \frac{V_{OUT}}{V_{IN}}\right) \times \left(R_{ESR} + \frac{1}{8 \times f_s \times C2}\right)$$

Where L₁ is the inductor value and RESR is the equivalent series resistance (ESR) value of the output capacitor.

In the case of ceramic capacitors, the impedance at the switching frequency is dominated by the capacitance. The output voltage ripple is mainly caused by the capacitance. For simplification, the output voltage ripple can be estimated by:

$$\Delta V_{OUT} = \frac{V_{OUT}}{8 \times f_s^2 \times L_1 \times C2} \times \left(1 - \frac{V_{OUT}}{V_{IN}}\right)$$

In the case of tantalum or electrolytic capacitors, the ESR dominates the impedance at the switching frequency. For simplification, the output ripple can be approximated to:

$$\Delta V_{OUT} = \frac{V_{OUT}}{f_s \times L_1} \times \left(1 - \frac{V_{OUT}}{V_{IN}}\right) \times R_{ESR}$$

The characteristics of the output capacitor also affect the stability of the regulation system. The MP8775 can be optimized for a wide range of capacitance and ESR values.

External Bootstrap Diode

An external bootstrap diode may enhance the efficiency of the regulator, the applicable conditions of external BST diode are:

- V_{OUT} is 5V or 3.3V; and
- Duty cycle is high: $D = \frac{V_{OUT}}{V_{IN}} > 65\%$

In these cases, an external BST diode is recommended from the VCC pin to BST pin, as shown in Figure 6.

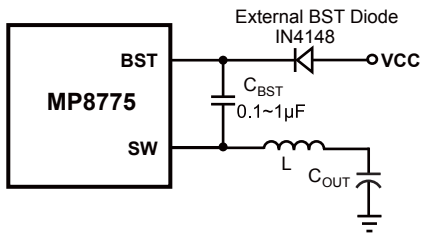
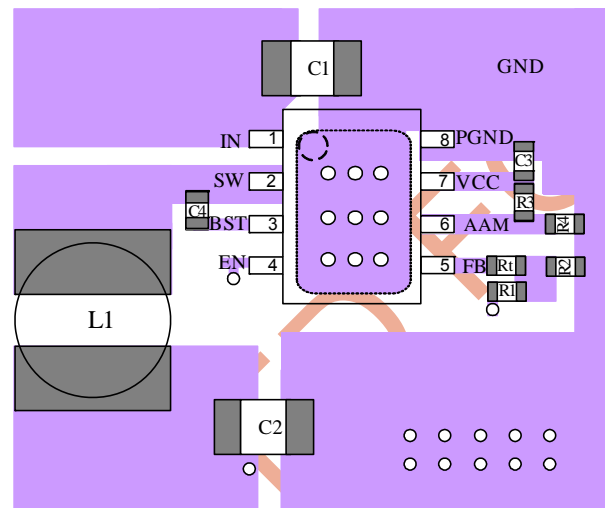

Figure 6—Add Optional External Bootstrap Diode to Enhance Efficiency

The recommended external BST diode is IN4148, and the BST cap is 0.1~1µF.

PC Board Layout

The high current paths (GND, IN and SW) should be placed very close to the device with short, direct and wide traces. The input capacitor needs to be as close as possible to the IN and GND pins. The external feedback resistors should be placed next to the FB pin. Keep the switching node SW short and away from the feedback network.



Top Layer

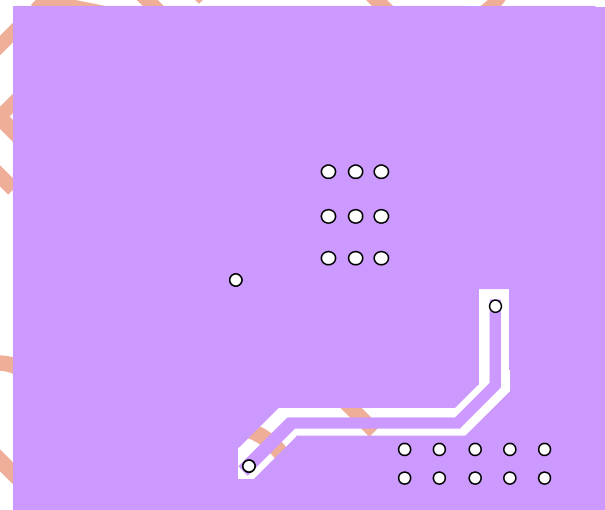

Bottom Layer

Figure 7—PCB Layout

PACKAGE INFORMATION

3mm x 4mm QFN14

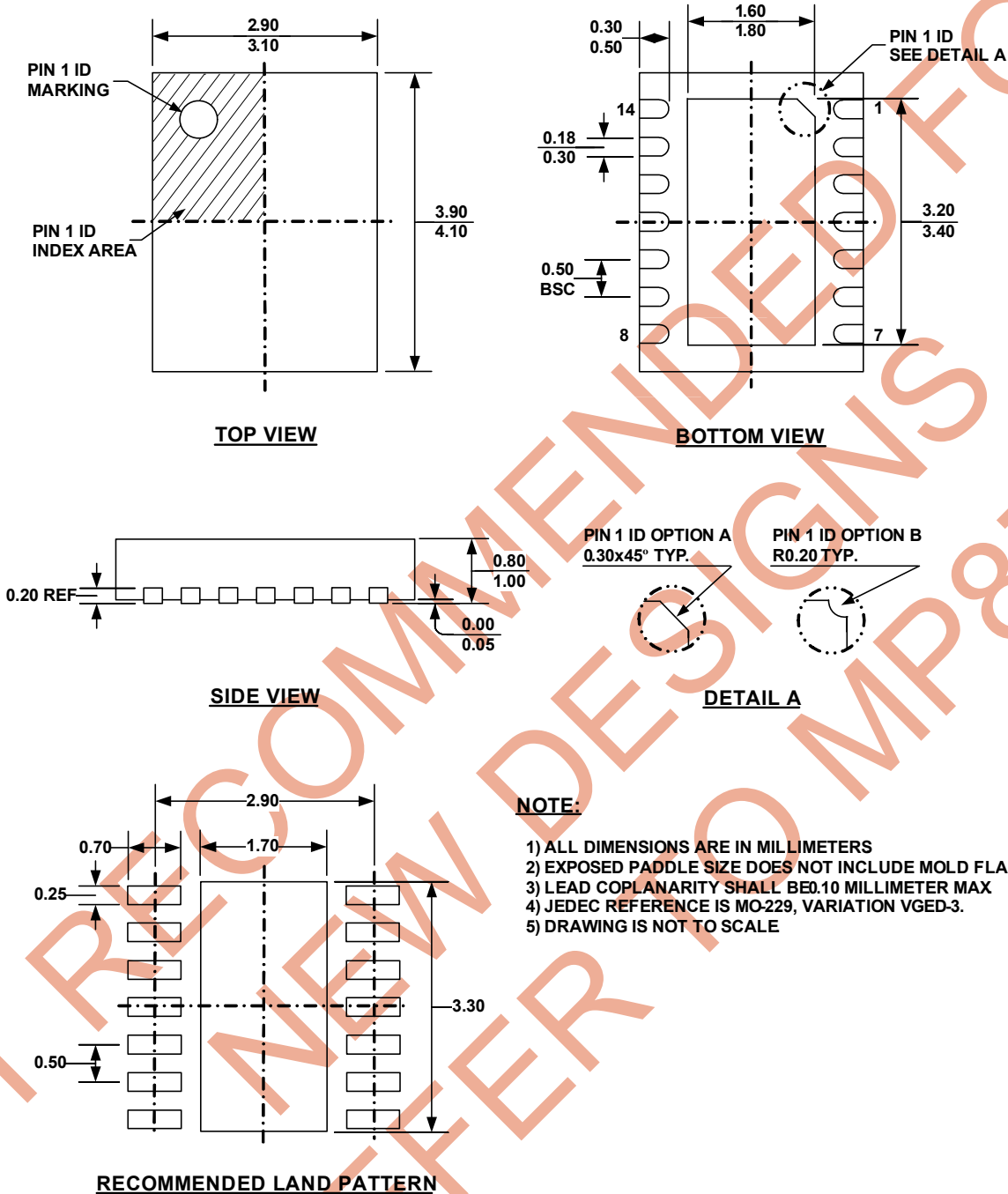

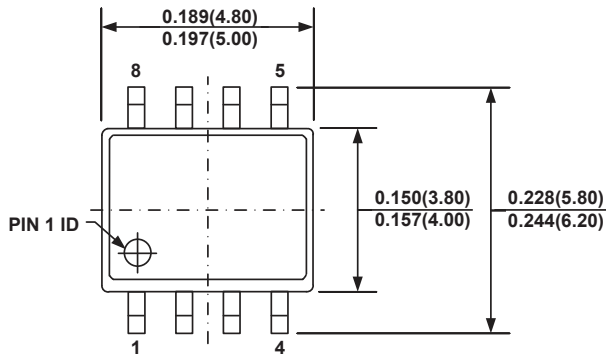
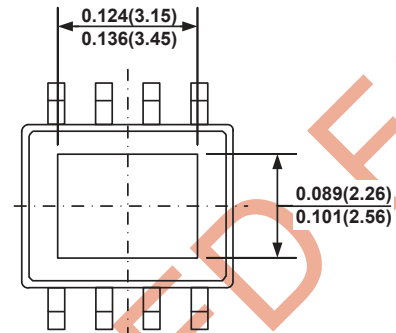
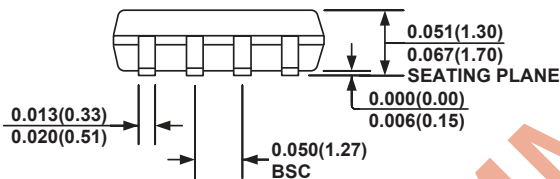
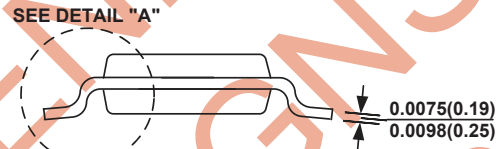
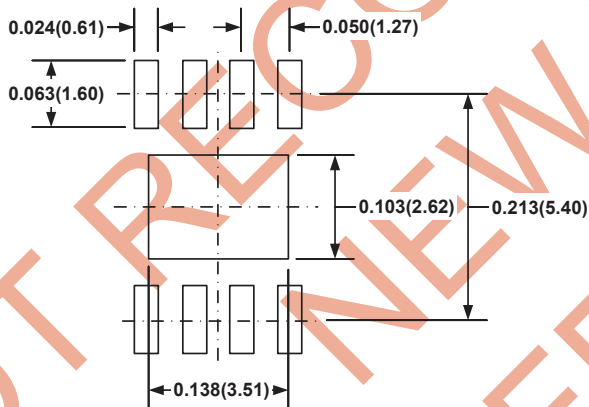
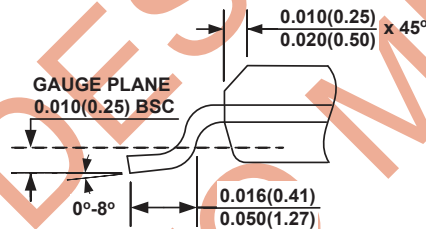
PACKAGE INFORMATION
SOIC8E (EXPOSED PAD)

TOP VIEW

BOTTOM VIEW

FRONT VIEW

SIDE VIEW

RECOMMENDED LAND PATTERN

DETAIL "A"
NOTE:

- 1) CONTROL DIMENSION IS IN INCHES. DIMENSION IN BRACKET IS IN MILLIMETERS.
- 2) PACKAGE LENGTH DOES NOT INCLUDE MOLD FLASH, PROTRUSIONS OR GATE BURRS.
- 3) PACKAGE WIDTH DOES NOT INCLUDE INTERLEAD FLASH OR PROTRUSIONS.
- 4) LEAD COPLANARITY (BOTTOM OF LEADS AFTER FORMING) SHALL BE 0.004" INCHES MAX.
- 5) DRAWING CONFORMS TO JEDEC MS-012, VARIATION BA.
- 6) DRAWING IS NOT TO SCALE.

NOTICE: The information in this document is subject to change without notice. Please contact MPS for current specifications. Users should warrant and guarantee that third party Intellectual Property rights are not infringed upon when integrating MPS products into any application. MPS will not assume any legal responsibility for any said applications.