

## DESCRIPTION

The MP8102 is a rail-to-rail output, operational amplifier in a TSOT-23 package. This amplifier provides 600KHz bandwidth while consuming an incredibly low 7.5 $\mu$ A of supply current. The MP8102 can operate with a single supply voltage as low as 1.8V.

## FEATURES

- Single Supply Operation: 1.8V to 5.5V
- TSOT23-5 Package
- 600KHz –3dB Bandwidth
- 7.5 $\mu$ A Supply Current
- Rail-to-Rail Output
- Unity-Gain Stable
- Input Common Mode to Ground
- Drives Up to 1000pF of Capacitive Loads

## APPLICATIONS

- Portable Equipment
- PDAs
- Pagers
- Cordless Phones
- Handheld GPS
- Consumer Electronics

All MPS parts are lead-free, halogen free, and adhere to the RoHS directive. For MPS green status, please visit MPS website under Quality Assurance. "MPS" and "The Future of Analog IC Technology" are Registered Trademarks of Monolithic Power Systems, Inc.

## TYPICAL APPLICATION

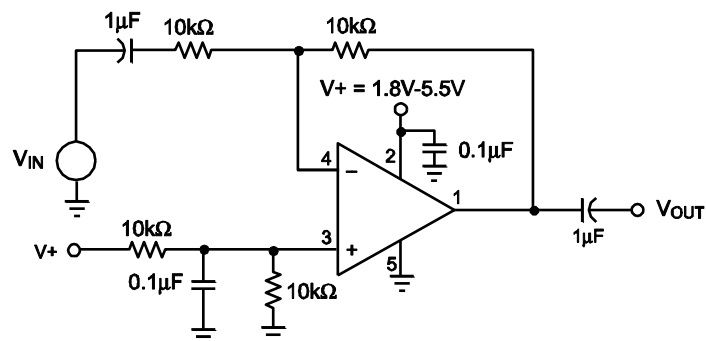

### ORDERING INFORMATION

Part Number*	Package	Top Marking
MP8102DJ	TSOT23-5	See Below

\* For Tape & Reel, add suffix -Z (e.g. MP8102DJ-Z);  
 For RoHS, compliant packaging, add suffix -LF (e.g. MP8102DJ-LF-Z).

### TOP MARKING

**|H6YW**

H6: product code of MP8102DJ;  
 Y: year code;  
 W: week code:

### PACKAGE REFERENCE

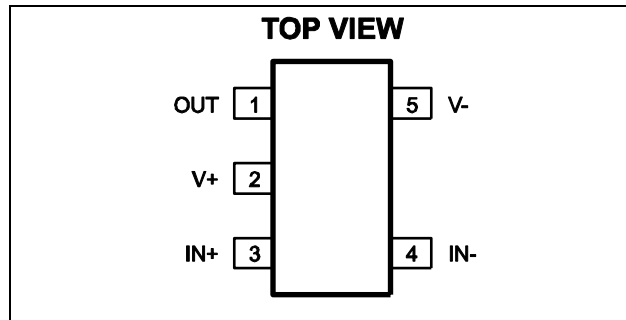

#### ABSOLUTE MAXIMUM RATINGS <sup>(1)</sup>

Supply Voltage (V+ to V-) .....+6.0V  
 Differential Input Voltage (V<sub>IN+</sub> – V<sub>IN-</sub>).....+6.0V  
 Input Voltage (V<sub>IN+</sub> – V<sub>IN-</sub>).. V<sub>IN+</sub> + 0.3V, V<sub>IN-</sub> – 0.3V  
 Junction Temperature ..... 150°C

#### Recommended Operating Conditions <sup>(2)</sup>

Supply Voltage ..... +1.8V to +5.5V  
 Operating Temperature..... –40°C to +85°C

**Thermal Resistance <sup>(3)</sup>**      $\theta_{JA}$       $\theta_{JC}$   
 TSOT23-5 ..... 220 .... 110.. °C/W

**Notes:**

- 1) Exceeding these ratings may damage the device.
- 2) The device is not guaranteed to function outside of its operating conditions.
- 3) Measured on approximately 1" square of 1 oz copper.

## ELECTRICAL CHARACTERISTICS

$V_+ = +5V$ ,  $V_- = 0V$ ,  $V_{CM} = V_+/2$ ,  $R_L = 10k\Omega$ ,  $T_A = +25^\circ C$ , unless otherwise noted.

Parameter	Symbol	Condition	Min	Typ	Max	Units
Input Offset Voltage	$V_{OS}$		-5	1	+5	mV
Input Offset Voltage Temp Coefficient				15		$\mu V/^\circ C$
Input Bias Current <sup>(4)</sup>	$I_B$			2		pA
Input Offset Current <sup>(4)</sup>	$I_{OS}$			0.2		pA
Input Voltage Range	$V_{CM}$	CMRR > 60dB	0		3.8	V
Common-Mode Rejection Ratio	CMRR	$0 < V_{CM} < 3.5V$		82		dB
Power Supply Rejection Ratio	PSRR	Supply Voltage change of 1.0V		80		dB
Large Signal Voltage Gain	$A_{VOL}$	$R_L = 100k\Omega$ , $V_{OUT} = 5.0$ Peak to Peak	60	88		dB
Maximum Output Voltage Swing	$V_{OUT}$	$R_L = 10k\Omega$		$V_+ - 23mV$		V
Minimum Output Voltage Swing	$V_{OUT}$	$R_L = 10k\Omega$		$V_- + 19mV$		V
Gain-Bandwidth Product <sup>(4)</sup>	GBW	$R_L = 200k\Omega, C_L = 2pF$ , $V_{OUT} = 0$		200		KHz
-3dB Bandwidth <sup>(4)</sup>	BW	$A_V = 1, C_L = 2pF$ , $R_L = 1M\Omega$		600		KHz
Slew Rate <sup>(4)</sup>	SR	$A_V = 1, C_L = 2pF$ , $R_L = 1M\Omega$		0.1		V/ $\mu s$
Short Circuit Current	$I_{SC}$	Source		-20		mA
		Sink		20		mA
Supply Current		No Load		7.5	10	$\mu A$

**Note:**

4) Guaranteed by design.

## PIN FUNCTIONS

Pin #	Name	Description
1	OUT	Output.
2	V+	Supply Voltage.
3	IN+	Non-Inverting Input.
4	IN-	Inverting Input.
5	V-	Ground or Supply Return Pin.

## TEST CIRCUITS

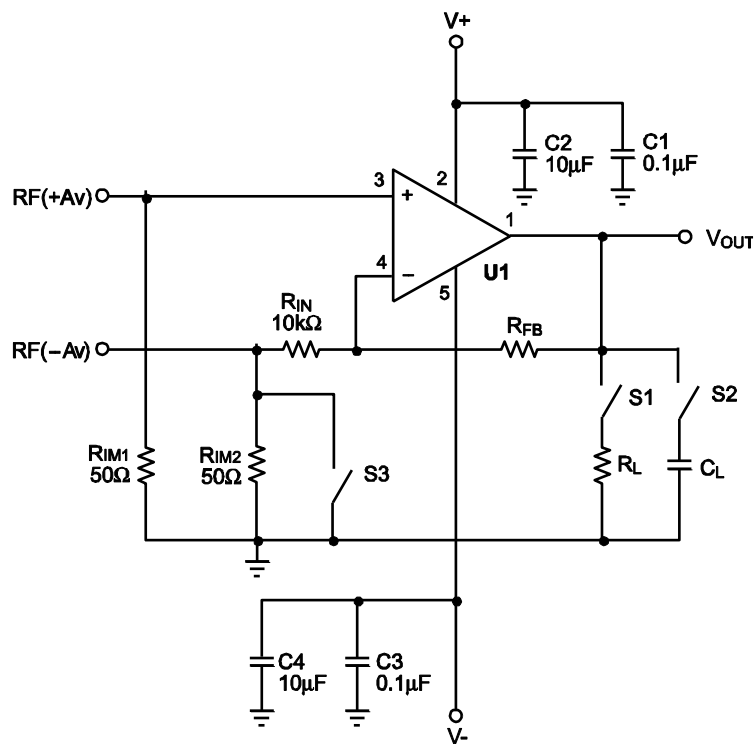

Notes: Close S3 for positive gain. Input signal to RF(+Av) connector.  
 The gain  $A_v = 1 + R_{FB}/R_{IN}$ .  
 For unity gain, remove  $R_{IN}$  and short  $R_{FB}$ .  
 Open S3 for negative gain. Input signal to RF(-Av) connector.  
 The gain  $A_v = -R_{FB}/R_{IN}$ .  
 S1 and S2 are switches for possible resistor and capacitor load connections.

Figure 1—AC Test Circuit

TEST CIRCUITS (continued)

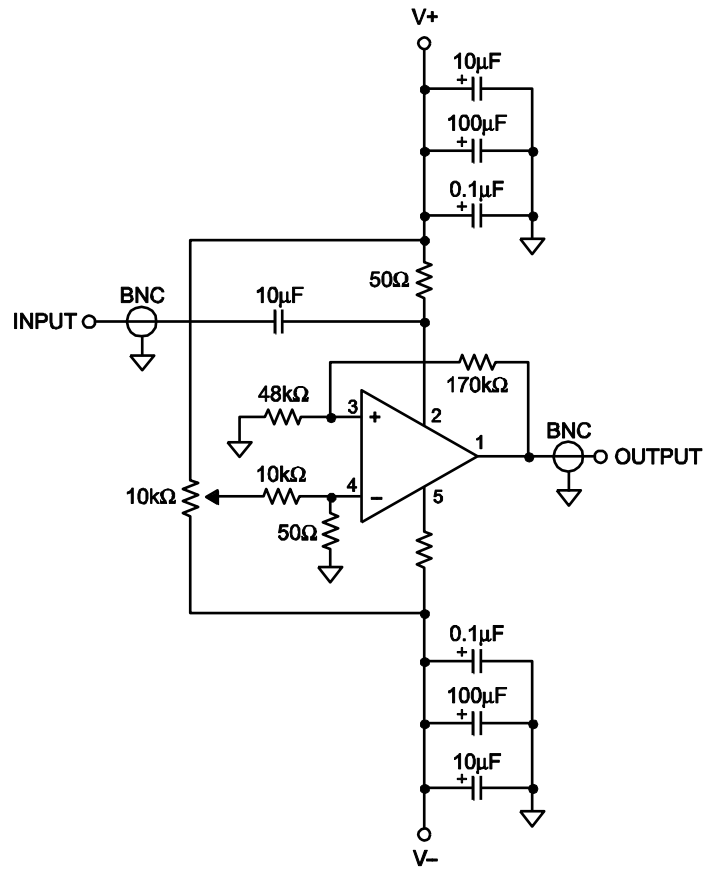
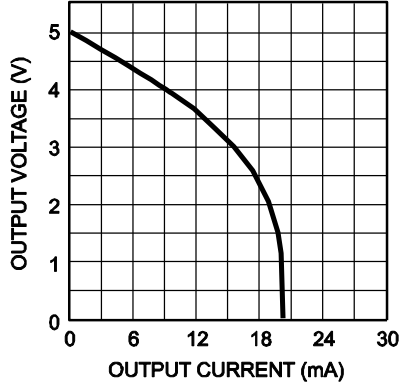

Figure 2—Positive Power Supply Rejection Ratio Measurement

## TYPICAL PERFORMANCE CHARACTERISTICS

$T_A = +25^\circ\text{C}$ , unless otherwise noted.

**Output Voltage vs. Output Current**  
Sourcing



**Output Voltage vs. Output Current**  
Sinking

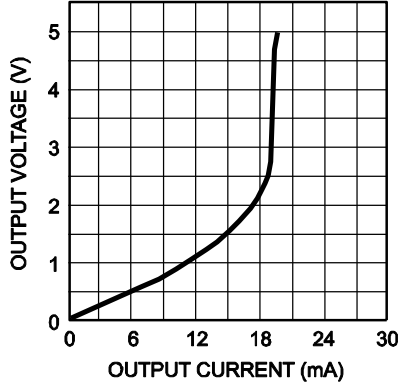

**Short Circuit Current vs. Supply Voltage**  
Sourcing

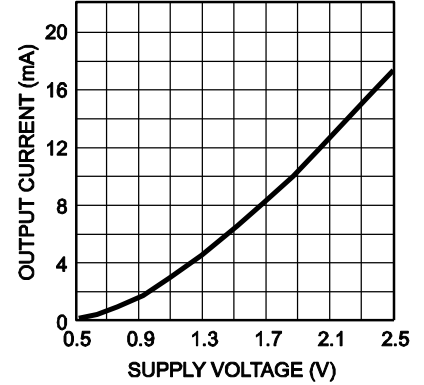

**Short Circuit Current vs. Supply Voltage**  
Sinking

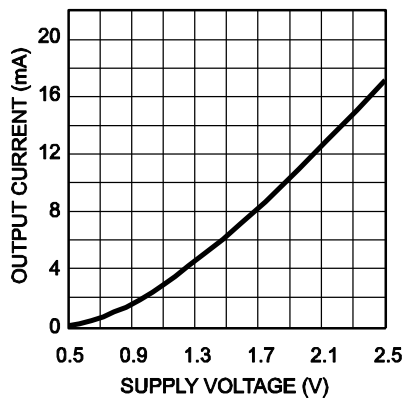

**Offset Voltage vs. Common Mode Voltage**  
 $R_{FB} = 50\text{k}\Omega$ ,  $V_- = -5\text{V}$  to  $0\text{V}$ ,  
 $V_+ = 0\text{V}$  to  $+5\text{V}$

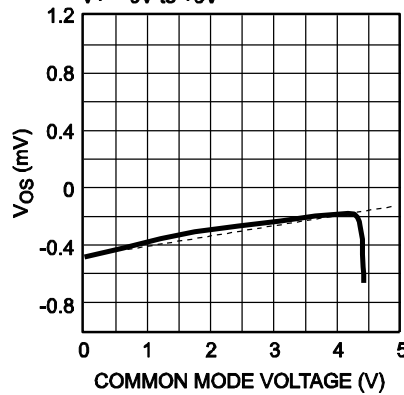

**Offset Voltage vs. Supply Voltage**  
 $R_{FB} = 50\text{k}\Omega$ ,  $V_- = -2.5\text{V}$  to  $0\text{V}$ ,  
 $V_+ = +2.5\text{V}$  to  $0\text{V}$

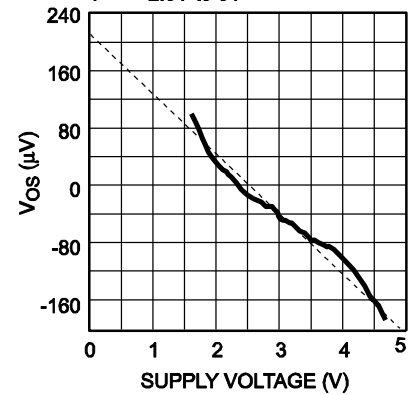

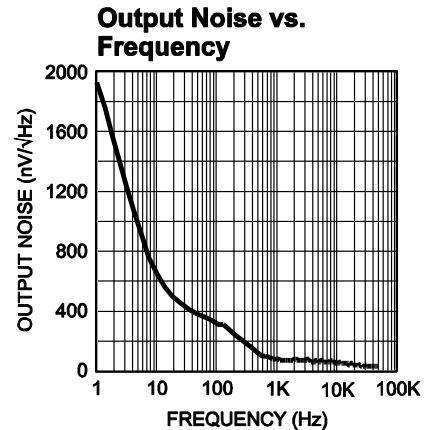
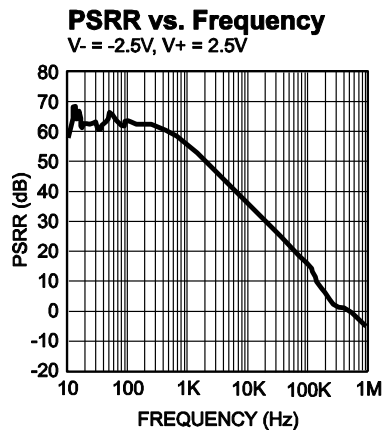
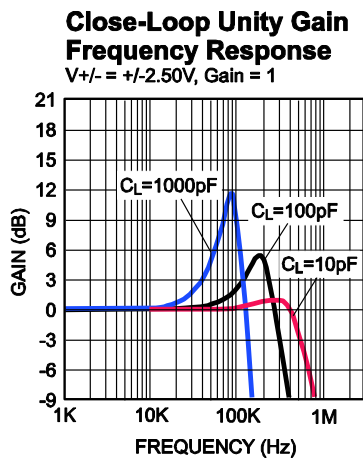
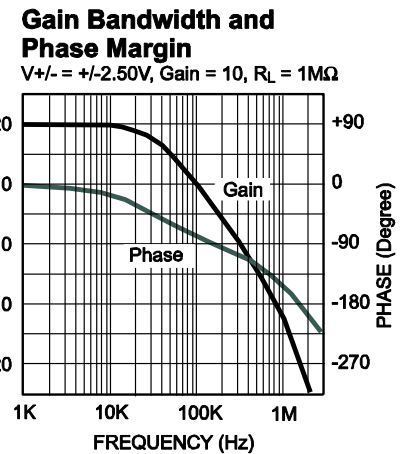
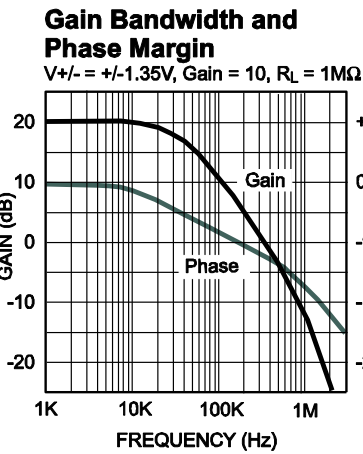
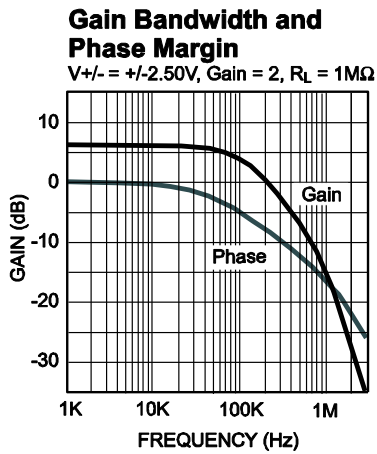
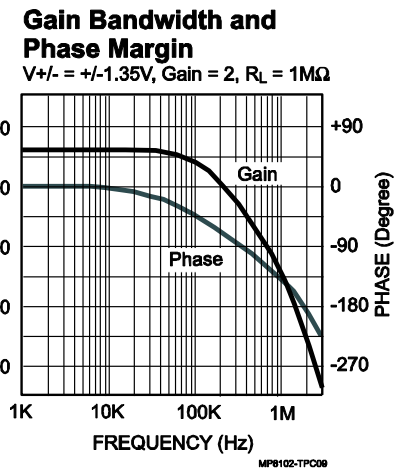
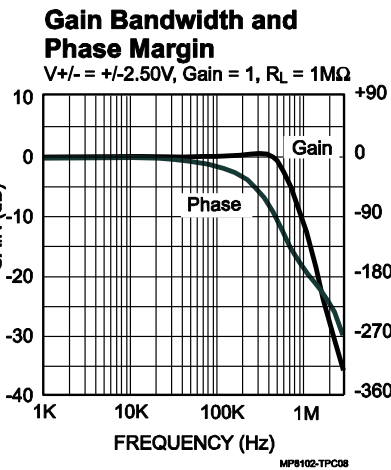
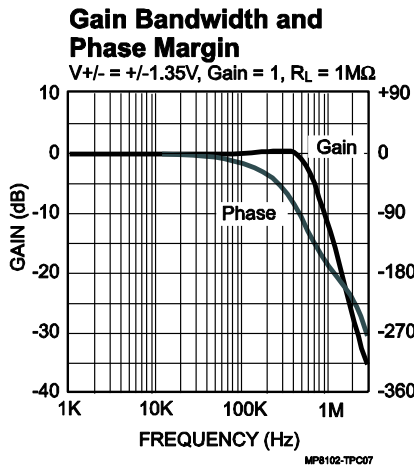
**TYPICAL PERFORMANCE CHARACTERISTICS (continued)**
 $T_A = +25^\circ\text{C}$ , unless otherwise noted.

**TYPICAL PERFORMANCE CHARACTERISTICS (continued)**
 $T_A = +25^\circ\text{C}$ , unless otherwise noted.

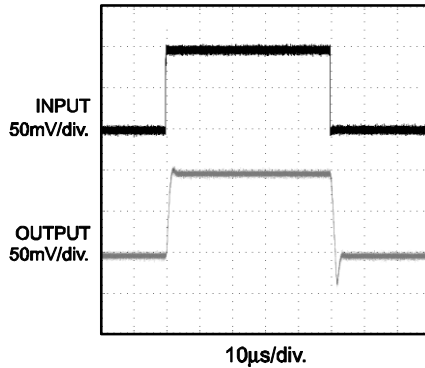
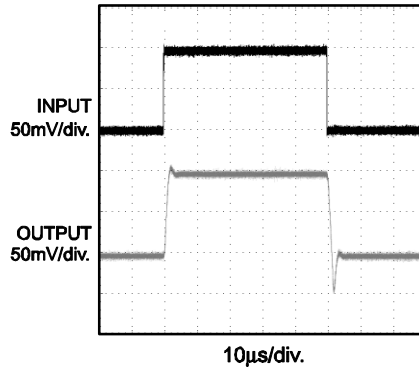
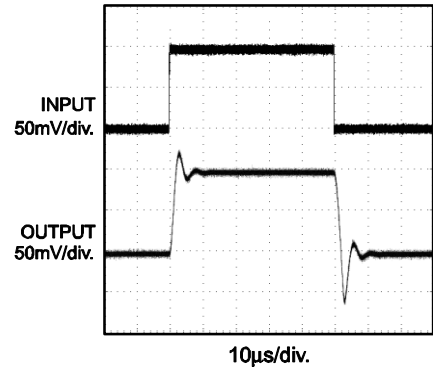
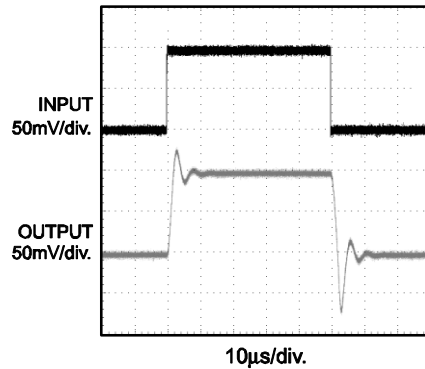
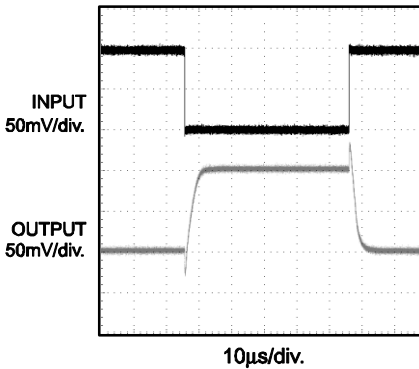
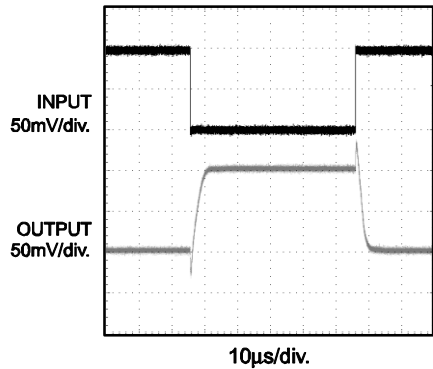
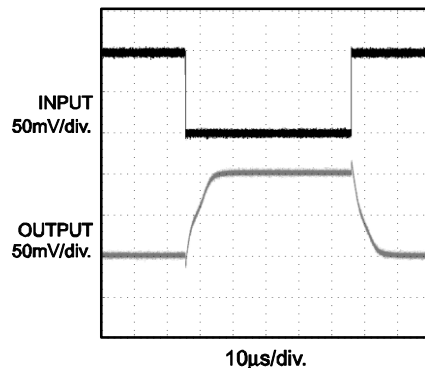
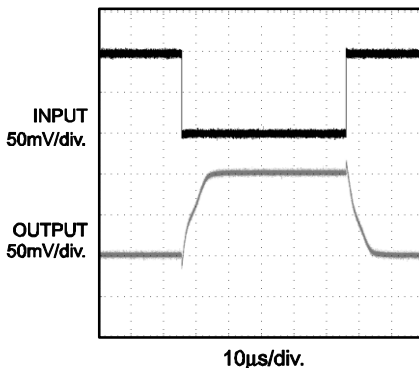
**Small Signal Pulse Response**
 $A_V = 1, V_+ = 2.5\text{V}, V_- = -2.5\text{V}$   
 $R_L = 1\text{M}\Omega, C_L = 8\text{pF}$ 

**Small Signal Pulse Response**
 $A_V = 1, V_+ = 1.25\text{V}, V_- = -1.25\text{V}$   
 $R_L = 1\text{M}\Omega, C_L = 8\text{pF}$ 

**Small Signal Pulse Response**
 $A_V = 1, V_+ = 2.5\text{V}, V_- = -2.5\text{V}$   
 $R_L = 1\text{M}\Omega, C_L = 50\text{pF}$ 

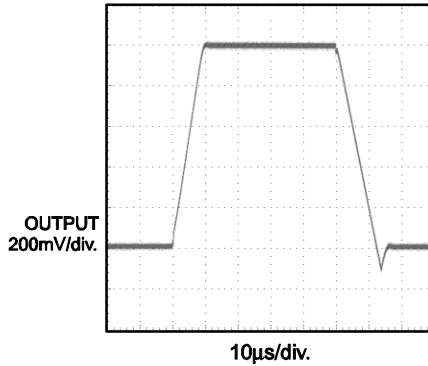
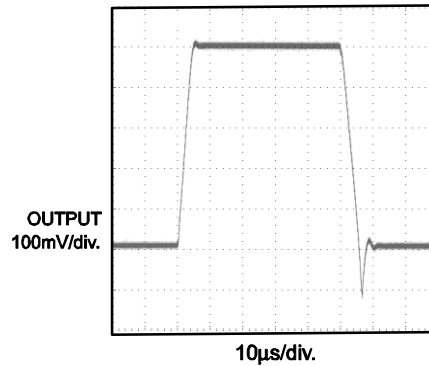
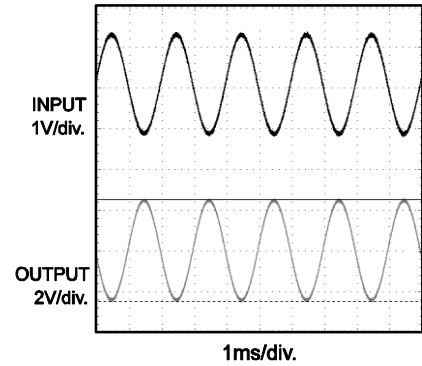
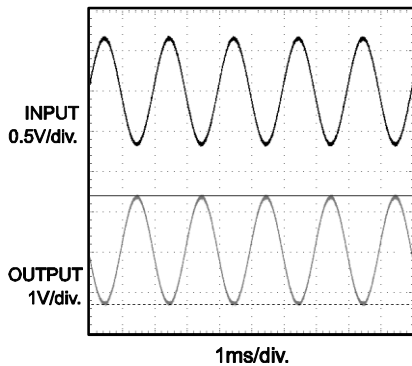
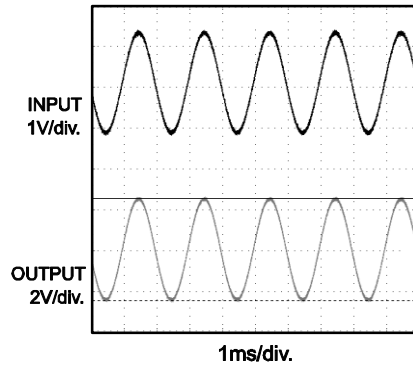
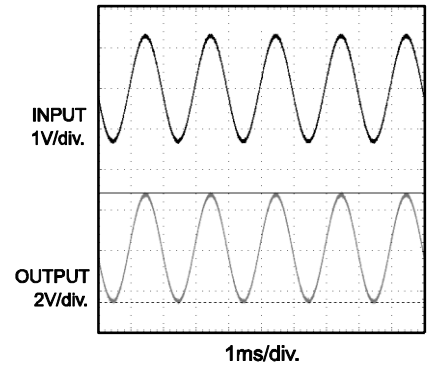
**Small Signal Pulse Response**
 $A_V = 1, V_+ = 1.25\text{V}, V_- = -1.25\text{V}$   
 $R_L = 1\text{M}\Omega, C_L = 50\text{pF}$ 

**Small Signal Pulse Response**
 $A_V = -1, V_+ = 2.5\text{V}, V_- = -2.5\text{V}$   
 $R_L = 1\text{M}\Omega, C_L = 8\text{pF}$ 

**Small Signal Pulse Response**
 $A_V = -1, V_+ = 1.25\text{V}, V_- = -1.25\text{V}$   
 $R_L = 1\text{M}\Omega, C_L = 8\text{pF}$ 

**Small Signal Pulse Response**
 $A_V = -1, V_+ = 2.5\text{V}, V_- = -2.5\text{V}$   
 $R_L = 5\text{k}\Omega, C_L = 8\text{pF}$ 

**Small Signal Pulse Response**
 $A_V = -1, V_+ = 1.25\text{V}, V_- = -1.25\text{V}$   
 $R_L = 5\text{k}\Omega, C_L = 8\text{pF}$ 



**TYPICAL PERFORMANCE CHARACTERISTICS (continued)**
 $T_A = +25^\circ\text{C}$ , unless otherwise noted.

**Large Signal Pulse Response**
 $A_v = 1$ ,  $V_+ = 2.5\text{V}$ ,  $V_- = -2.5\text{V}$   
 $R_L = 1\text{M}\Omega$ ,  $C_L = 8\text{pF}$ 

**Large Signal Pulse Response**
 $A_v = 1$ ,  $V_+ = 1.25\text{V}$ ,  $V_- = -1.25\text{V}$   
 $R_L = 1\text{M}\Omega$ ,  $C_L = 8\text{pF}$ 

**Rail to Rail Output Operation**
 $A_v = -2$ ,  $V_+ = 2.5\text{V}$ ,  $V_- = -2.5\text{V}$   
 $R_L = 1\text{M}\Omega$ ,  $C_L = 8\text{pF}$ 

**Rail to Rail Output Operation**
 $A_v = -2$ ,  $V_+ = 1.25\text{V}$ ,  $V_- = -1.25\text{V}$   
 $R_L = 1\text{M}\Omega$ ,  $C_L = 8\text{pF}$ 

**Rail to Rail Output Operation**
 $A_v = 2$ ,  $V_+ = 2.5\text{V}$ ,  $V_- = -2.5\text{V}$   
 $R_L = 1\text{M}\Omega$ ,  $C_L = 8\text{pF}$ 

**Rail to Rail Output Operation**
 $A_v = 2$ ,  $V_+ = 1.25\text{V}$ ,  $V_- = -1.25\text{V}$   
 $R_L = 1\text{M}\Omega$ ,  $C_L = 8\text{pF}$ 

## APPLICATION INFORMATION

### Power Supply Bypassing

Regular supply bypassing techniques are recommended. A 10 $\mu$ F capacitor in parallel with a 0.1 $\mu$ F capacitor on both the positive and negative supplies is ideal. For the best

performance, all bypassing capacitors should be located as close to the op amp as possible and all capacitors should be low ESL (Equivalent Series Inductance) and low ESR (Equivalent Series Resistance). Surface mount ceramic capacitors are ideal.

## PACKAGE INFORMATION

### TSOT23-5

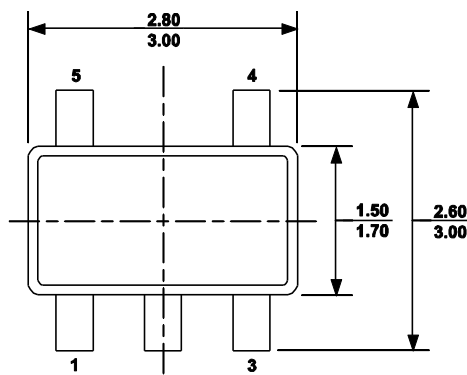

**TOP VIEW**

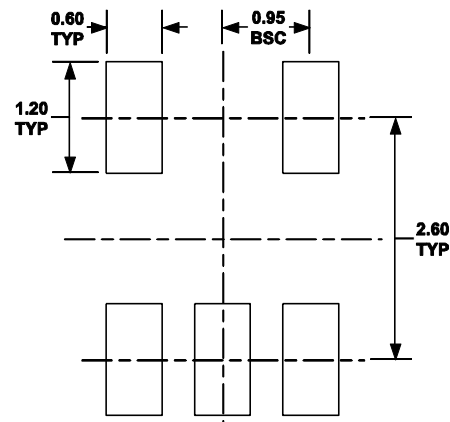

**RECOMMENDED LAND PATTERN**

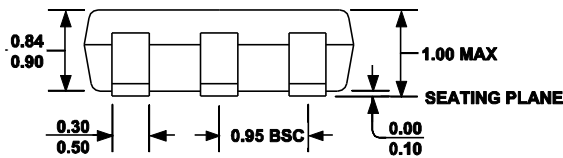

**FRONT VIEW**

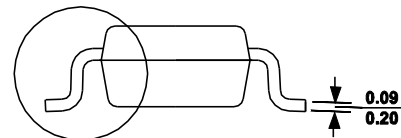

**SIDE VIEW**

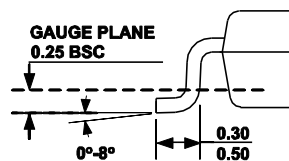

**DETAIL "A"**

#### NOTE:

- 1) ALL DIMENSIONS ARE IN MILLIMETERS.
- 2) PACKAGE LENGTH DOES NOT INCLUDE MOLD FLASH, PROTRUSION OR GATE BURR.
- 3) PACKAGE WIDTH DOES NOT INCLUDE INTERLEAD FLASH OR PROTRUSION.
- 4) LEAD COPLANARITY (BOTTOM OF LEADS AFTER FORMING) SHALL BE 0.10 MILLIMETERS MAX.
- 5) DRAWING CONFORMS TO JEDEC MO-193, VARIATION AA.
- 6) DRAWING IS NOT TO SCALE.

**NOTICE:** The information in this document is subject to change without notice. Users should warrant and guarantee that third party Intellectual Property rights are not infringed upon when integrating MPS products into any application. MPS will not assume any legal responsibility for any said applications.