



The Future of Analog IC Technology™

# MP29368

1.2A, 24V, 1.4MHz

Step-Down Converter in a TSOT23-6

## DESCRIPTION

The MP29368 is a monolithic step-down switch mode converter with a built-in power MOSFET. It achieves 1.2A peak output current over a wide input supply range with excellent load and line regulation. Current mode operation provides fast transient response and eases loop stabilization. Fault condition protection includes cycle-by-cycle current limiting and thermal shutdown.

The MP29368 requires a minimum number of readily available standard external components. The MP29368 is available in TSOT23-6 package.

## FEATURES

- 1.2A Peak Output Current
- 0.35Ω Internal Power MOSFET Switch
- Stable with Low ESR Output Ceramic Capacitors
- Up to 92% Efficiency
- 0.1μA Shutdown Mode
- Fixed 1.4MHz Frequency
- Thermal Shutdown
- Cycle-by-Cycle Over Current Protection
- Wide 4.5V to 24V Operating Input Range
- Output Adjustable from 0.81V to 15V
- Available in TSOT23-6 Package

## APPLICATIONS

- Distributed Power Systems
- Battery Charger
- Pre-Regulator for Linear Regulators
- WLED Drivers

"MPS" and "The Future of Analog IC Technology" are Trademarks of Monolithic Power Systems, Inc.

## TYPICAL APPLICATION

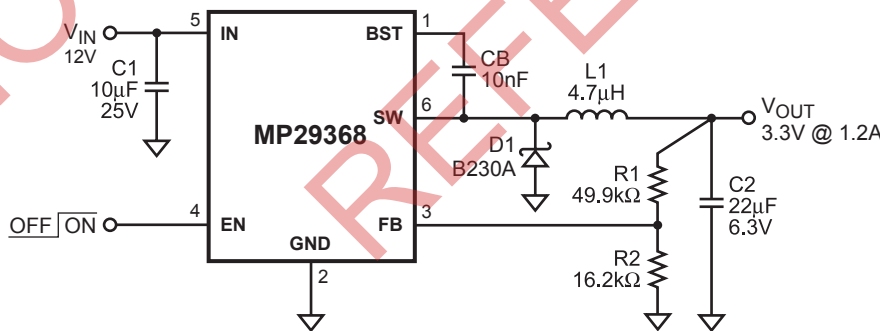

Efficiency vs Load Currents

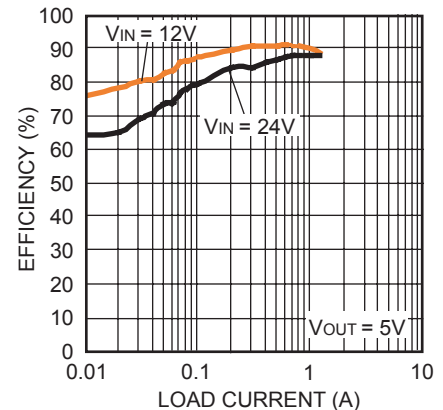

## PACKAGE REFERENCE

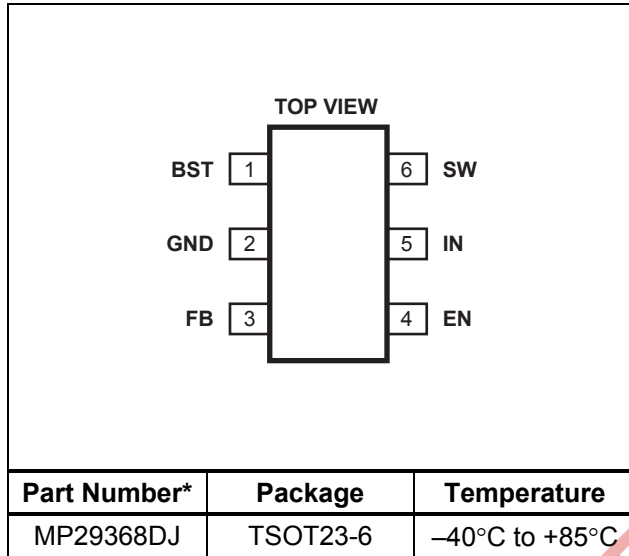

\* For Tape & Reel, add suffix -Z (eg. MP29368DJ-Z)  
 For RoHS compliant packaging, add suffix -LF (eg. MP29368DJ-LF-Z)

## ABSOLUTE MAXIMUM RATINGS <sup>(1)</sup>

Supply Voltage $V_{IN}$ .....	26V
$V_{SW}$ .....	-0.3V to $V_{IN} + 0.3V$
$V_{BS}$ .....	$V_{SW} + 6V$
All Other Pins.....	-0.3V to +6V
Junction Temperature.....	150°C
Lead Temperature.....	260°C
Storage Temperature.....	-65°C to +150°C

## Recommended Operating Conditions <sup>(2)</sup>

Supply Voltage $V_{IN}$ .....	4.5V to 24V
Output Voltage $V_{OUT}$ .....	0.81V to 15V
Ambient Temperature.....	-40°C to +85°C

Thermal Resistance <sup>(3)</sup>	$\theta_{JA}$	$\theta_{JC}$
TSOT23-6.....	220	110

### Notes:

- Exceeding these ratings may damage the device.
- The device function is not guaranteed outside of the recommended operating conditions.
- Measured on approximately 1" square of 1 oz copper.

## ELECTRICAL CHARACTERISTICS

$V_{IN} = 12V$ ,  $T_A = +25^\circ C$ , unless otherwise noted.

Parameters	Symbol	Condition	Min	Typ	Max	Units
Feedback Voltage	$V_{FB}$	$4.5V \leq V_{IN} \leq 24V$	0.790	0.810	0.830	V
Feedback Current	$I_{FB}$	$V_{FB} = 0.8V$		0.1		$\mu A$
Switch-On Resistance <sup>(4)</sup>	$R_{DS(ON)}$			0.35		$\Omega$
Switch Leakage		$V_{EN} = 0V$ , $V_{SW} = 0V$			10	$\mu A$
Current Limit <sup>(4)</sup>				1.8		A
Oscillator Frequency	$f_{SW}$	$V_{FB} = 0.6V$	1.2	1.4	1.7	MHz
Fold-back Frequency		$V_{FB} = 0V$		460		KHz
Maximum Duty Cycle		$V_{FB} = 0.6V$		87		%
Minimum On-Time <sup>(4)</sup>	$t_{ON}$			100		ns
Under Voltage Lockout Threshold Rising			2.5	2.8	3.1	V
Under Voltage Lockout Threshold Hysteresis				150		mV
EN Input Low Voltage					0.4	V
EN Input High Voltage			1.2			V
EN Input Current		$V_{EN} = 2V$		2.1		$\mu A$
		$V_{EN} = 0V$		0.1		
Supply Current (Shutdown)	$I_S$	$V_{EN} = 0V$		0.1	1.0	$\mu A$
Supply Current (Quiescent)	$I_Q$	$V_{EN} = 2V$ , $V_{FB} = 1V$		0.8	1.0	mA
Thermal Shutdown <sup>(4)</sup>				150		$^\circ C$

### Note:

4) Guaranteed by design.

## PIN FUNCTIONS

Pin #	Name	Description
1	BST	Bootstrap. A capacitor is connected between SW and BS pins to form a floating supply across the power switch driver. This capacitor is needed to drive the power switch's gate above the supply voltage.
2	GND	Ground. This pin is the voltage reference for the regulated output voltage. For this reason care must be taken in its layout. This node should be placed outside of the D1 to C1 ground path to prevent switching current spikes from inducing voltage noise into the part.
3	FB	Feedback. An external resistor divider from the output to GND, tapped to the FB pin sets the output voltage. To prevent current limit run away during a short circuit fault condition, the frequency foldback comparator lowers the oscillator frequency when the FB voltage is below 250mV.
4	EN	On/Off Control Input. Pull EN above 1.2V to turn the device on.
5	IN	Supply Voltage. The MP29368 operates from a +4.5V to +24V unregulated input. C1 is needed to prevent large voltage spikes from appearing at the input.
6	SW	Switch Output.

## TYPICAL PERFORMANCE CHARACTERISTICS

$V_{IN} = 12V$ ,  $V_{OUT} = 3.3V$ ,  $L = 4.7\mu H$ ,  $C1 = 10\mu F$ ,  $C2 = 22\mu F$ ,  $T_A = +25^\circ C$ , unless otherwise noted.

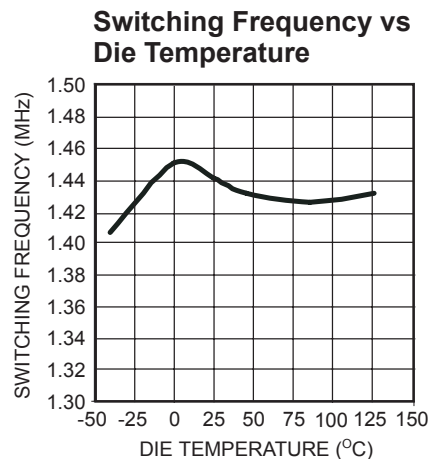
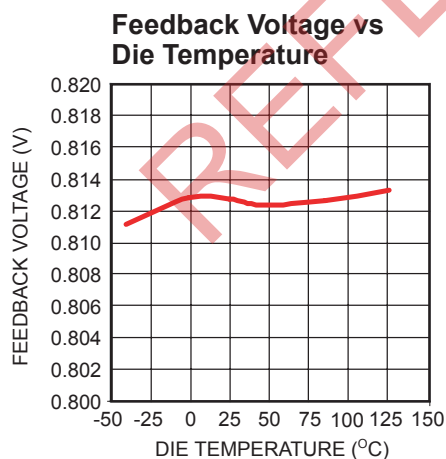
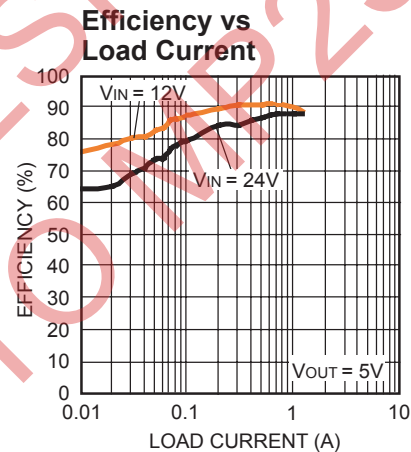
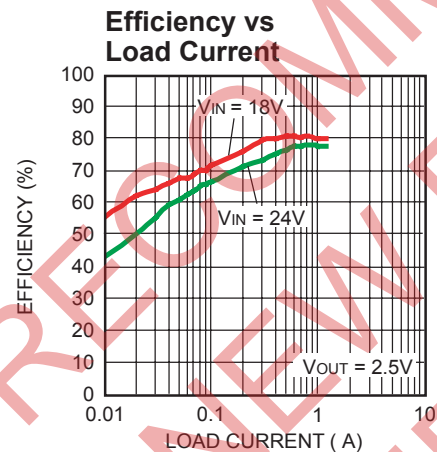

**TYPICAL PERFORMANCE CHARACTERISTICS** *(continued)*

$V_{IN} = 12V$ ,  $V_{OUT} = 3.3V$ ,  $L = 4.7\mu H$ ,  $C1 = 10\mu F$ ,  $C2 = 22\mu F$ ,  $T_A = +25^\circ C$ , unless otherwise noted.

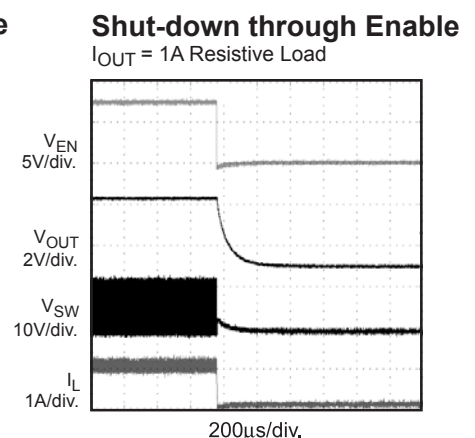
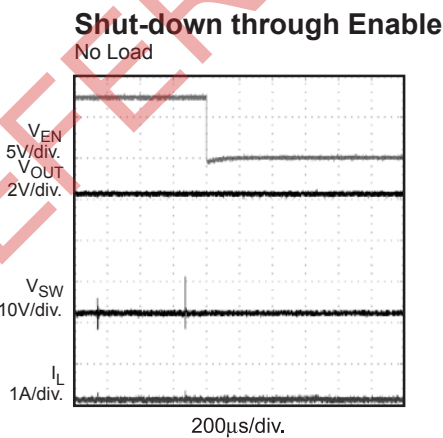
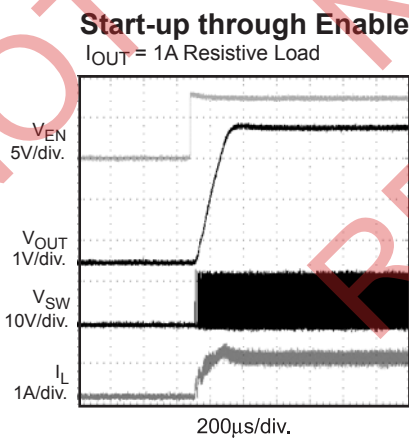
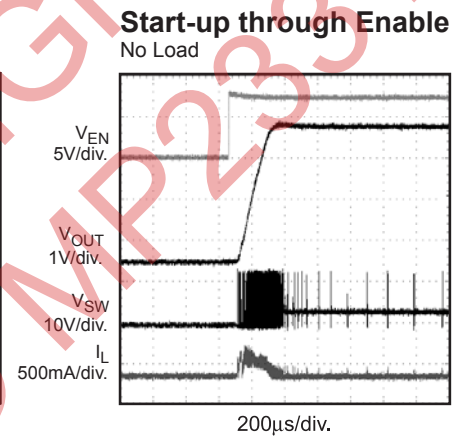
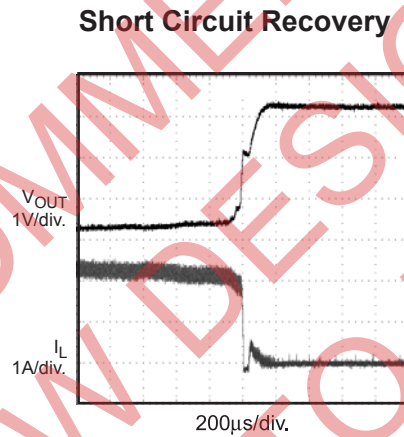
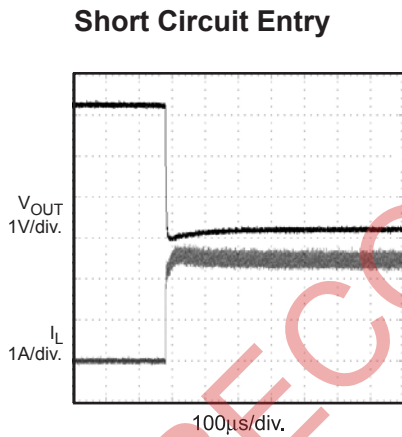
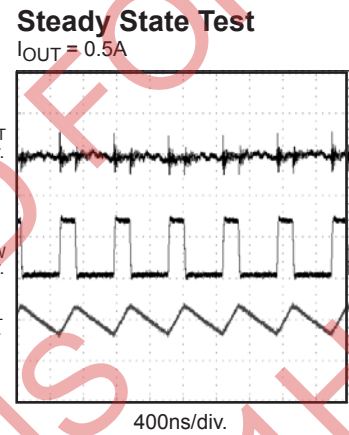
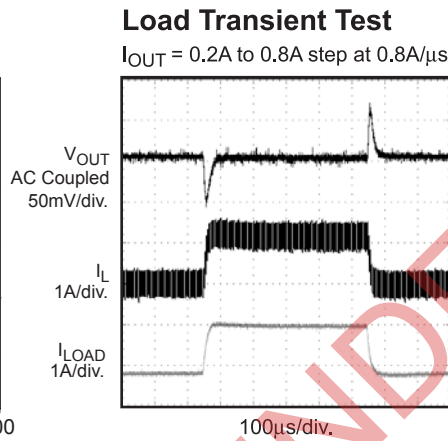
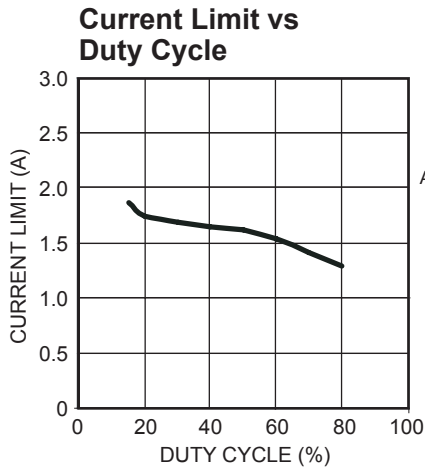

### OPERATION

The MP29368 is a current mode buck regulator. That is, the EA output voltage is proportional to the peak inductor current.

At the beginning of a cycle, M1 is off. The EA output voltage is higher than the current sense amplifier output, and the current comparator's output is low. The rising edge of the 1.4MHz CLK signal sets the RS Flip-Flop. Its output turns on M1 thus connecting the SW pin and inductor to the input supply.

The increasing inductor current is sensed and amplified by the Current Sense Amplifier. Ramp compensation is summed to the Current Sense Amplifier output and compared to the Error Amplifier output by the PWM Comparator. When the sum of the Current Sense Amplifier output and the Slope Compensation signal exceeds the EA output voltage, the RS Flip-Flop is reset and M1 is turned off. The external Schottky rectifier diode (D1) conducts the inductor current.

If the sum of the Current Sense Amplifier output and the Slope Compensation signal does not exceed the EA output for a whole cycle, then the falling edge of the CLK resets the Flip-Flop.

The output of the Error Amplifier integrates the voltage difference between the feedback and the 0.81V bandgap reference. The polarity is such that a FB pin voltage lower than 0.81V increases the EA output voltage. Since the EA output voltage is proportional to the peak inductor current, an increase in its voltage also increases current delivered to the output.

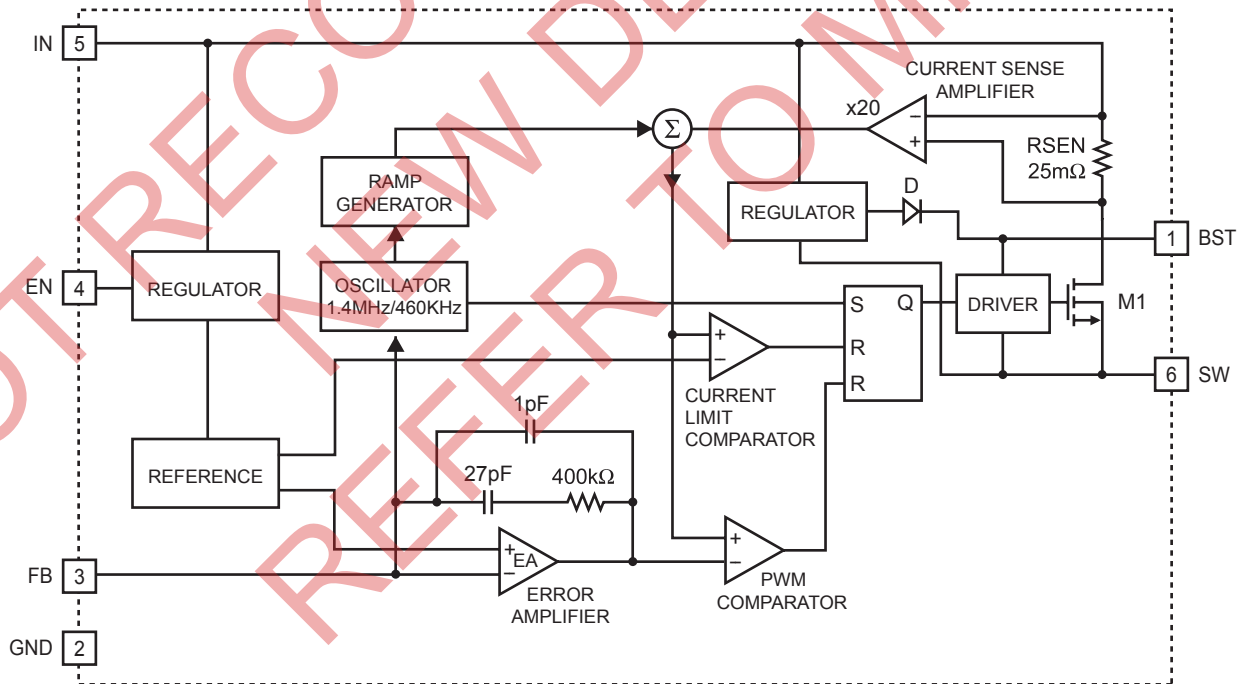

Figure 1—Functional Block Diagram

## APPLICATION INFORMATION

### Setting Output Voltage

The external resistor divider is used to set the output voltage (see the schematic on front page). Table 1 shows a list of resistor selection for common output voltages. The feedback resistor R1 also sets the feedback loop bandwidth with the internal compensation capacitor (see Figure 1). R2 can be determined by:

$$R2 = \frac{R1}{\frac{V_{OUT}}{0.81V} - 1}$$

**Table 1—Resistor Selection for Common Output Voltages**

V <sub>OUT</sub> (V)	R1 (kΩ)	R2 (kΩ)
1.8	80.6 (1%)	64.9 (1%)
2.5	49.9 (1%)	23.7 (1%)
3.3	49.9 (1%)	16.2 (1%)
5	49.9 (1%)	9.53 (1%)

### Selecting the Inductor

A 1μH to 10μH inductor with a DC current rating of at least 25% percent higher than the maximum load current is recommended for most applications. For highest efficiency, the inductor's DC resistance should be less than 200mΩ. Refer to Table 2 for suggested surface mount inductors. For most designs, the required inductance value can be derived from the following equation.

$$L = \frac{V_{OUT} \times (V_{IN} - V_{OUT})}{V_{IN} \times \Delta I_L \times f_{SW}}$$

Where ΔI<sub>L</sub> is the inductor ripple current.

Choose the inductor ripple current to be 30% of the maximum load current. The maximum inductor peak current is calculated from:

$$I_{L(MAX)} = I_{LOAD} + \frac{\Delta I_L}{2}$$

Under light load conditions below 100mA, a larger inductance is recommended for improved efficiency. See Table 2 for suggested inductors.

Also note that the maximum recommended load current is 1A if the duty cycle exceeds 35%.

### Selecting the Input Capacitor

The input capacitor reduces the surge current drawn from the input supply and the switching noise from the device. The input capacitor impedance at the switching frequency should be less than the input source impedance to prevent high frequency switching current from passing through the input. Ceramic capacitors with X5R or X7R dielectrics are highly recommended because of their low ESR and small temperature coefficients. For most applications, a 4.7μF capacitor is sufficient.

### Selecting the Output Capacitor

The output capacitor keeps the output voltage ripple small and ensures feedback loop stability. The output capacitor impedance should be low at the switching frequency. Ceramic capacitors with X5R or X7R dielectrics are recommended for their low ESR characteristics. For most applications, a 22μF ceramic capacitor will be sufficient.

### PC Board Layout

The high current paths (GND, IN and SW) should be placed very close to the device with short, direct and wide traces. The input capacitor needs to be as close as possible to the IN and GND pins. The external feedback resistors should be placed next to the FB pin. Keep the switch node traces short and away from the feedback network.

### External Bootstrap Diode

It is recommended that an external bootstrap diode be added when the input voltage is no greater than 5V or the 5V rail is available in the system. This helps improve the efficiency of the regulator. The bootstrap diode can be a low cost one such as IN4148 or BAT54.

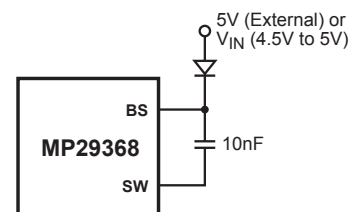

**Figure 2—External Bootstrap Diode**

This diode is also recommended for high duty cycle operation (when  $\frac{V_{OUT}}{V_{IN}} > 65\%$ ) applications.

**Table 2—Suggested Surface Mount Inductors**

Manufacturer	Part Number	Inductance( $\mu$ H)	Max DCR( $\Omega$ )	Current Rating (A)	Dimensions L x W x H (mm <sup>3</sup> )
Toko	A921CY-4R7M	4.7	0.027	1.66	6 x 6.3 x 3
Sumida	CDRH4D28C/LD	4.7	0.036	1.5	5.1 x 5.1 x 3
Würth Electronics	7440530047	4.7	0.038	2.0	5.8 x 5.8 x 2.8

## TYPICAL APPLICATION CIRCUITS

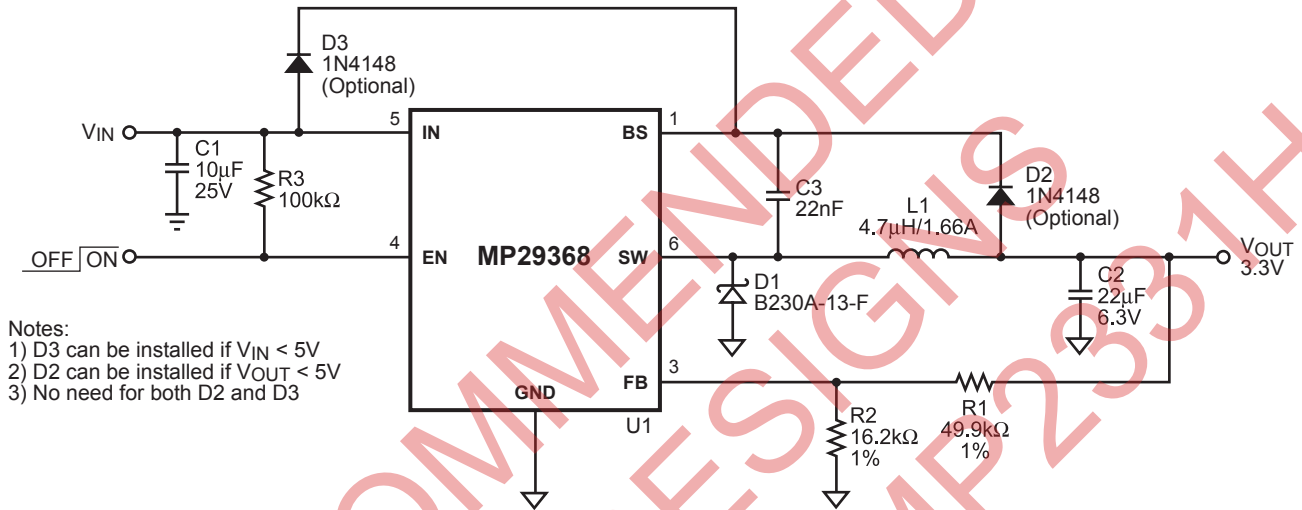
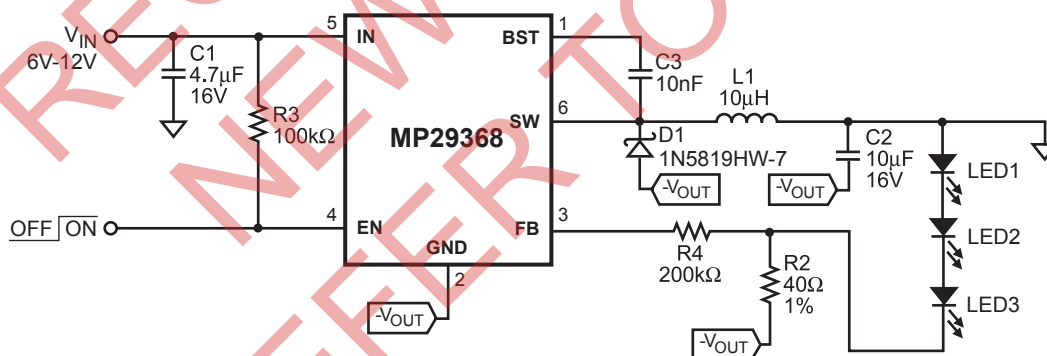
**Figure 3—1.4MHz, 3.3V Output at 1A Step-Down Converter**

**Figure 4—White LED Driver Application**

## PACKAGE INFORMATION

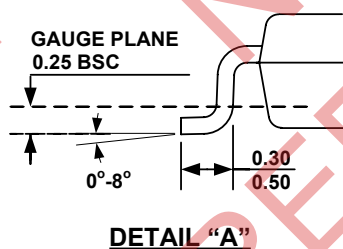
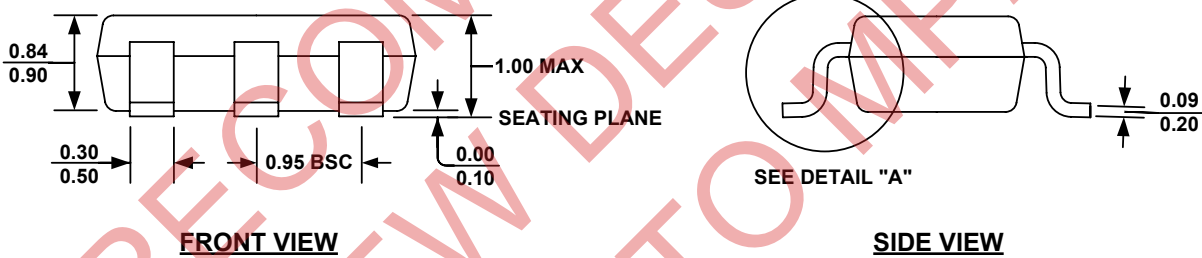
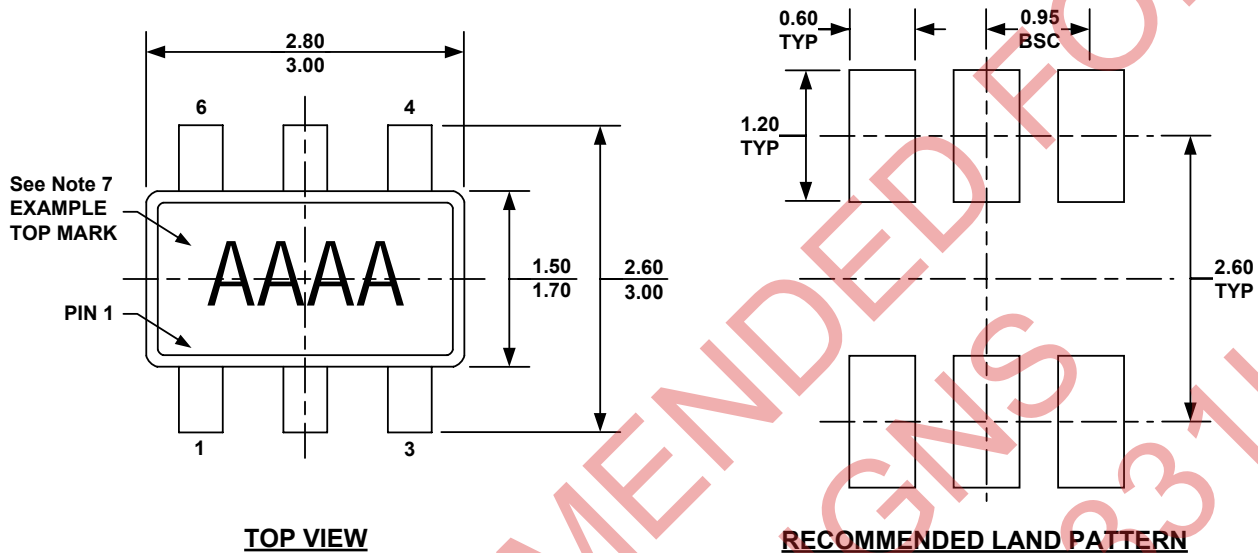
### TSOT23-6



#### NOTE:

- 1) ALL DIMENSIONS ARE IN MILLIMETERS.
- 2) PACKAGE LENGTH DOES NOT INCLUDE MOLD FLASH, PROTRUSION OR GATE BURR.
- 3) PACKAGE WIDTH DOES NOT INCLUDE INTERLEAD FLASH OR PROTRUSION.
- 4) LEAD COPLANARITY (BOTTOM OF LEADS AFTER FORMING) SHALL BE 0.10 MILLIMETERS MAX.
- 5) DRAWING CONFORMS TO JEDEC MO-193, VARIATION AB.
- 6) DRAWING IS NOT TO SCALE.
- 7) PIN 1 IS LOWER LEFT PIN WHEN READING TOP MARK FROM LEFT TO RIGHT, (SEE EXAMPLE TOP MARK)

**NOTICE:** The information in this document is subject to change without notice. Please contact MPS for current specifications. Users should warrant and guarantee that third party Intellectual Property rights are not infringed upon when integrating MPS products into any application. MPS will not assume any legal responsibility for any said applications.