

DESCRIPTION

The MP2152A is a monolithic, step-down, switch-mode converter with built-in, internal power MOSFETs. The MP2152A achieves 2A of continuous output current from a 2.5V to 5.5V input voltage with excellent load and line regulation. The output voltage can be regulated as low as 0.6V.

The constant-on-time (COT) control scheme provides fast transient response and eases loop stabilization. Fault protections include cycle-by-cycle current limiting and thermal shutdown.

The MP2152A is ideal for a wide range of applications including high performance DSPs, wireless power, portable and mobile devices, and other low-power systems.

The MP2152A requires a minimal number of readily available, standard, external components and is available in 1.2mmx1.6mm UTQFN packages.

FEATURES

- Low I_Q: 25µA
- 1.1MHz Switching Frequency
- EN for Power Sequencing
- 1% FB Accuracy
- Wide 2.5V to 5.5V Operating Input Range
- Output Adjustable from 0.6V
- Up to 2A Output Current
- 75mΩ and 45mΩ Internal Power MOSFET Switches
- 100% Duty On
- Output Discharge
- V_{OUT} Over-Voltage Protection (OVP)
- Short-Circuit Protection (SCP) with Hiccup Mode
- Power Good Only for Fixed Output Version
- Available in UTQFN (1.2mmx1.6mm) Packages

APPLICATIONS

- Wireless/Networking Cards
- Portable Instruments
- Battery-Powered Devices
- Low-Voltage I/O System Power
- Multi-Function Printers
- Solid-State Drives

All MPS parts are lead-free, halogen-free, and adhere to the RoHS directive. For MPS green status, please visit the MPS website under Quality Assurance. "MPS" and "The Future of Analog IC Technology" are registered trademarks of Monolithic Power Systems, Inc.

TYPICAL APPLICATION

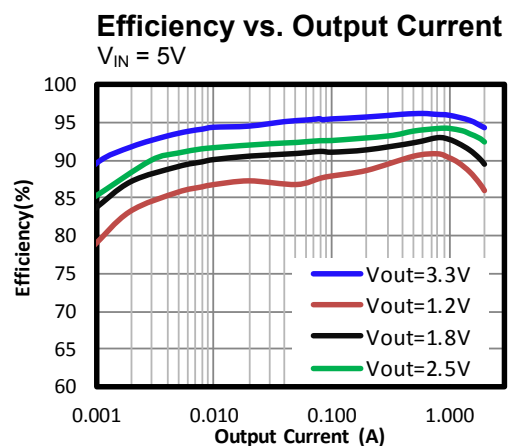
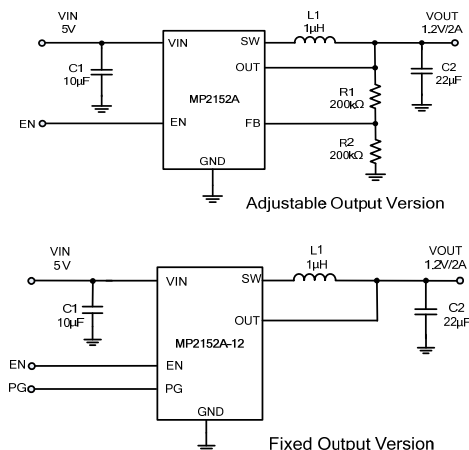

ORDERING INFORMATION

Part Number*	Package	Top Marking	V _{OUT} Range
MP2152AGQFU	UTQFN (1.2mmx1.6mm)	See Below	Adjustable
MP2152AGQFU-12**			Fixed 1.2V

* For Tape & Reel, add suffix –Z (e.g. MP2152AGQFU–Z)

** Contact factory for fixed output options

TOP MARKING (MP2152AGQFU)

—
JR

LL

JR: Product code of MP2152AGQFU

LL: Lot number

TOP MARKING (MP2152AGQFU-12)

—
JT

LL

JT: Product code of MP2152AGQFU-12

LL: Lot number

PACKAGE REFERENCE

TOP VIEW				TOP VIEW			
GND	1	6	OUT	GND	1	6	OUT
SW	2	5	FB	SW	2	5	PG
VIN	3	4	EN	VIN	3	4	EN
Adjustable Version MP2152AGQFU				Fixed V_{OUT} Version MP2152AGQFU-12			

ABSOLUTE MAXIMUM RATINGS ⁽¹⁾

Supply voltage (V _{IN})	6.5V
V _{SW}	-0.3V (-5V for <10ns) to 6.5V (10V for <10ns)
All other pins	-0.3V to 6.5 V
Junction temperature	150°C
Lead temperature	260°C
Continuous power dissipation (T _A = +25°C)	2W (2) (4)
Storage temperature.....	-65°C to +150°C

Recommended Operating Conditions ⁽³⁾

Supply voltage (V _{IN})	2.5V to 5.5V
Operating junction temp. (T _J)...	-40°C to +125°C

Thermal Resistance	θ_{JA}	θ_{JC}
QFN (1.2mmx16mm)		
EV2152-QFU-00A ⁽⁴⁾	65	30... °C/W
JESD51-7 ⁽⁵⁾	173.....	127.. °C/W

NOTES:

- 1) Exceeding these ratings may damage the device.
- 2) The maximum allowable power dissipation is a function of the maximum junction temperature T_J (MAX), the junction-to-ambient thermal resistance θ_{JA} , and the ambient temperature T_A. The maximum allowable continuous power dissipation at any ambient temperature is calculated by P_D (MAX) = (T_J (MAX)-T_A)/ θ_{JA} . Exceeding the maximum allowable power dissipation produces an excessive die temperature, causing the regulator to go into thermal shutdown. Internal thermal shutdown circuitry protects the device from permanent damage.
- 3) The device is not guaranteed to function outside of its operating conditions.
- 4) Measured on EV2152-QFU-00A demo board, 2-layer PCB.
- 5) Measured on JESD51-7, 4-layer PCB.

ELECTRICAL CHARACTERISTICS

V_{IN} = 3.6V, T_J = -40°C to +125°C ⁽⁶⁾, typical value is tested at T_J = +25°C. The limit over temperature is guaranteed by characterization, unless otherwise noted.

Parameter	Symbol	Condition	Min	Typ	Max	Units
V _{IN} range			2.5		5.5	V
Under-voltage lockout threshold rising				2.3	2.45	V
Under-voltage lockout threshold hysteresis				200		mV
Feedback voltage	V _{FB}	T _J = 25°C	594	600	606	mV
		T _J = -40°C to +125°C	591	600	609	
OUT voltage (MP2152AGQFU-12)	V _O	T _J = 25°C	1188	1200	1212	mV
		T _J = -40°C to +125°C	1182	1200	1218	mV
Feedback current	I _{FB}	V _{FB} = 0.63V		50	100	nA
P-FET switch on resistance	R _{DSON P}	V _{IN} = 5V		75		mΩ
N-FET switch on resistance	R _{DSON N}	V _{IN} = 5V		45		mΩ
Switch leakage		V _{EN} = 0V, V _{IN} = 6V, V _{SW} = 0V and 6V, T _J = +25°C		0	1	μA
P-FET peak current limit			2.8		4	A
N-FET valley current limit				2.5		A
ZCD				50		mA
On time	T _{ON}	V _{IN} = 5V, V _{OUT} = 1.2V	180	220	260	ns
		V _{IN} = 3.6V, V _{OUT} = 1.2V	240	300	360	
Switching frequency	f _s	V _{OUT} = 1.2V		1100		kHz
Minimum off time	T _{MIN-OFF}			100		ns
Minimum on time ⁽⁸⁾	T _{MIN-ON}			60		ns
Soft-start time	T _{SS-ON}	V _{OUT} rise from 10% to 90%		0.5		ms
Maximum duty cycle			100			%
Power good rising threshold UV		Fixed V _{OUT} version, FB rising edge		90		%
Power good falling threshold UV		Fixed V _{OUT} version, FB falling edge		85		%
Power good rising threshold OV		Fixed V _{OUT} version, FB rising edge		115		%
Power good falling threshold OV		Fixed V _{OUT} version, FB falling edge		105		%

ELECTRICAL CHARACTERISTICS (continued)

V_{IN} = 3.6V, T_J = -40°C to +125°C ⁽⁶⁾, typical value is tested at T_J = +25°C. The limit over temperature is guaranteed by characterization, unless otherwise noted.

Parameter	Symbol	Condition	Min	Typ	Max	Units
Power good delay	PGD	Fixed V _{OUT} version, PG rising/falling edge		150		μ s
Power good sink current capability	VPG-L	Fixed V _{OUT} version, sink 1mA			0.4	V
Power good logic high voltage	VPG-H	Fixed V _{OUT} version, V _{IN} = 5V, V _{OUT} = fixed OUT	4.9			V
EN turn-on delay		EN on to SW active		150		μ s
EN input logic low voltage					0.4	V
EN input logic high voltage			1.2			V
Output discharge resistor	RDIS	V _{EN} = 0V, V _{OUT} = 1.2V		200		Ω
EN input current		V _{EN} = 2V		1.2		μ A
		V _{EN} = 0V		0		μ A
Supply current (shutdown)		V _{EN} = 0V, T _J = +25°C		0	1	μ A
Supply current (quiescent)		V _{EN} = 2V, V _{FB} = 0.63V, V _{IN} = 5V, T _J = +25°C		30	35	μ A
Output over-voltage threshold	VOVP		110%	115%	120%	V _{FB}
V _{OUT} OVP hysteresis	VOVP_HYS			10%		V _{FB}
OVP delay				12		μ s
Low-side current		Current flow from SW to GND		1.5		A
Absolute V _{IN} OVP		After V _{OUT} OVP enables		6.1		V
Absolute V _{IN} OVP hysteresis				400		mV
Thermal shutdown ⁽⁷⁾				160		°C
Thermal hysteresis ⁽⁷⁾				30		°C

NOTES:

6) Guaranteed by over-temperature correlation, not tested in production.

7) Guaranteed by engineering sample characterization.

TYPICAL CHARACTERISTICS

V_{IN} = 3.6V, V_{OUT} = 1.2V, L = 1 μ H, C_{OUT} = 22 μ F, T_A = +25°C, unless otherwise noted.

Quiescent Current vs. Input Voltage

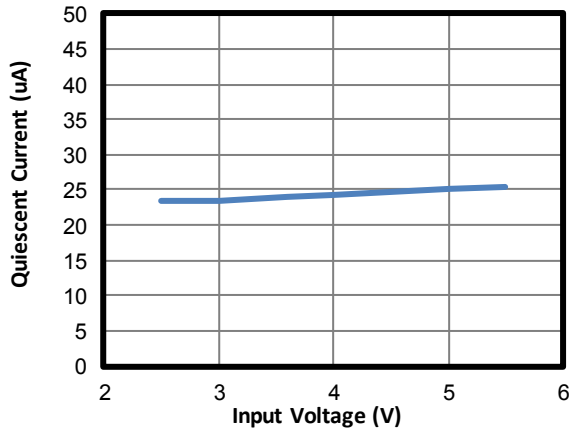

Shutdown Current vs. Input Voltage

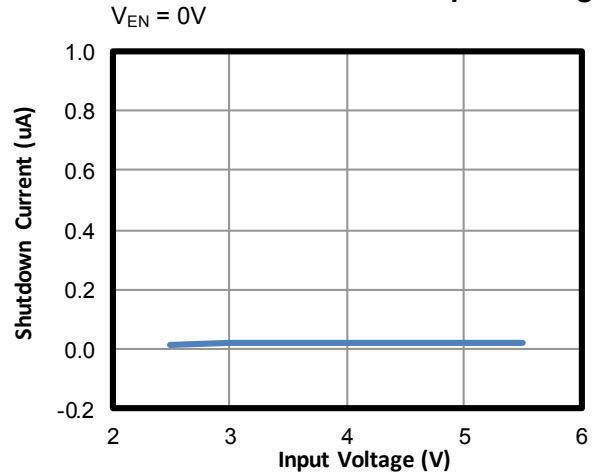

Load Regulation vs. Output Current

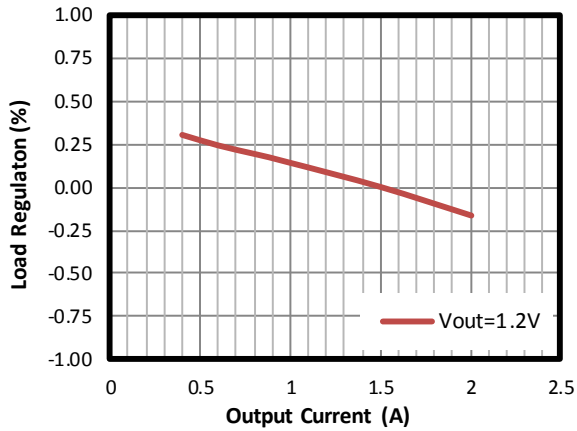

Line Regulation vs. Output Current

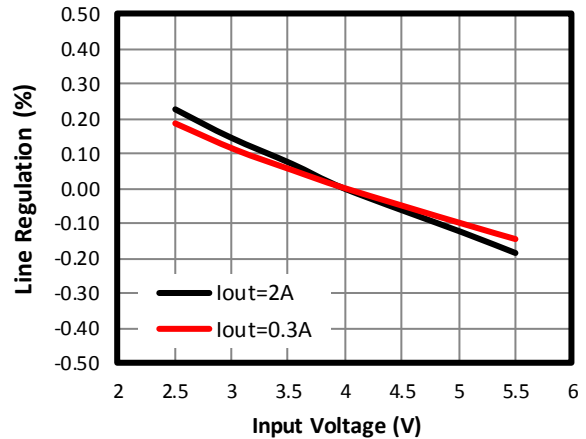

T_{RISE} vs. Output Current

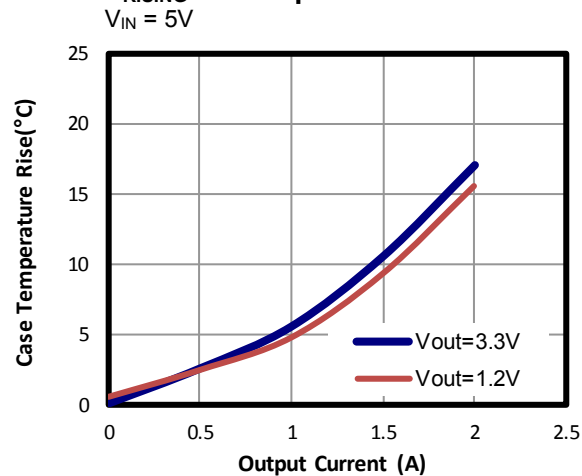

Efficiency vs. Output Current

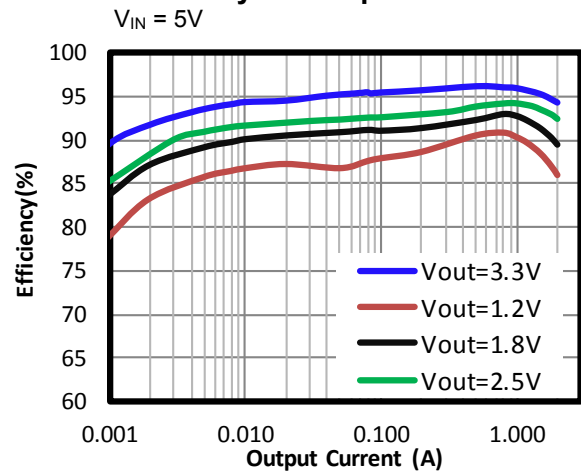

TYPICAL CHARACTERISTICS (continued)

 V_{IN} = 3.6V, V_{OUT} = 1.2V, L = 1 μ H, C_{OUT} = 22 μ F, T_A = +25 $^{\circ}$ C, unless otherwise noted.

Efficiency vs. Output Current

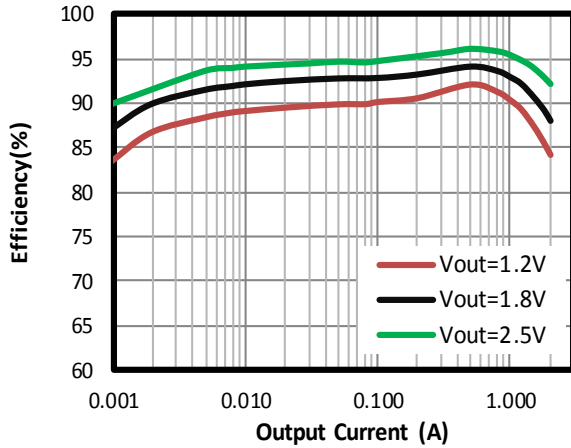
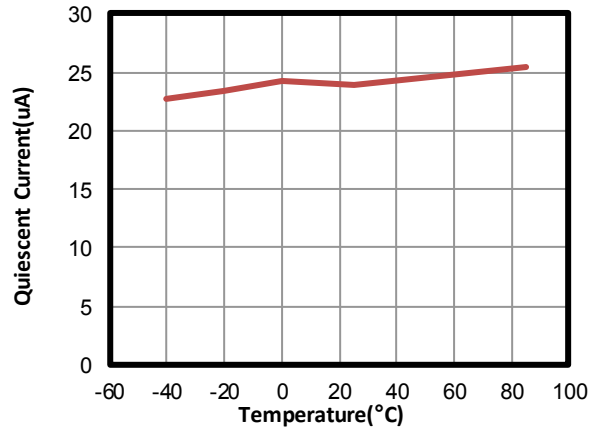
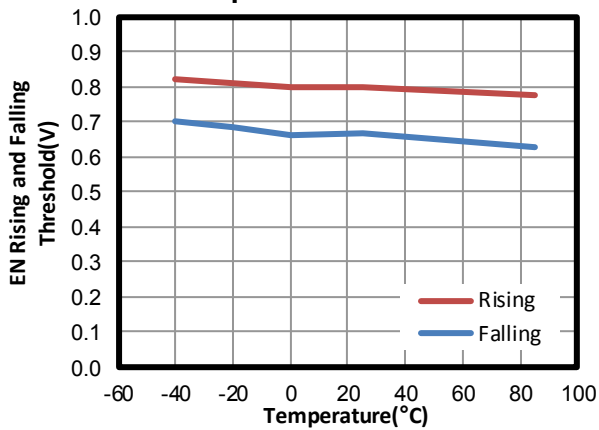
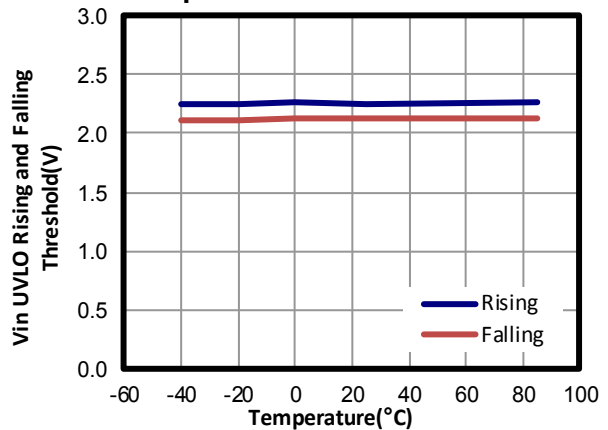
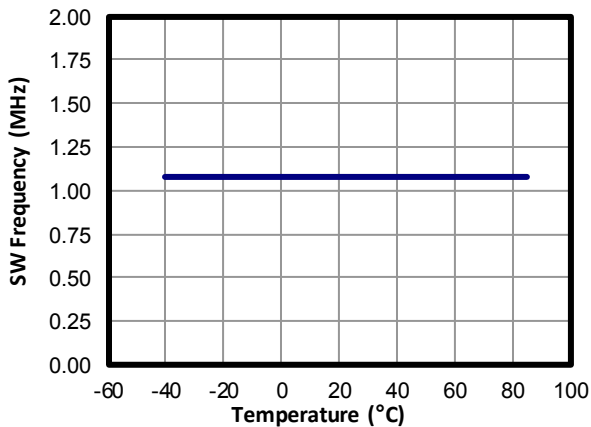
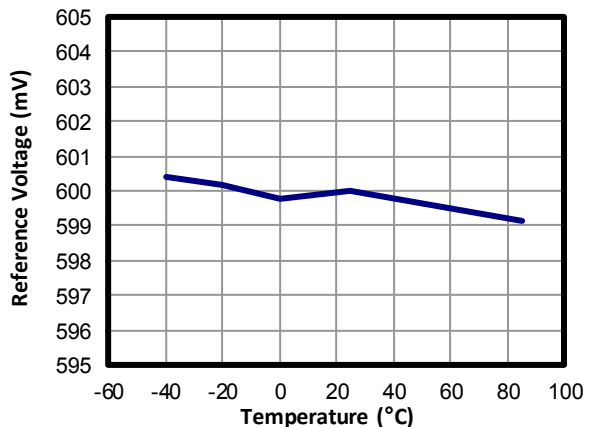
 V_{IN} = 3.6V

Quiescent Current vs. Temperature

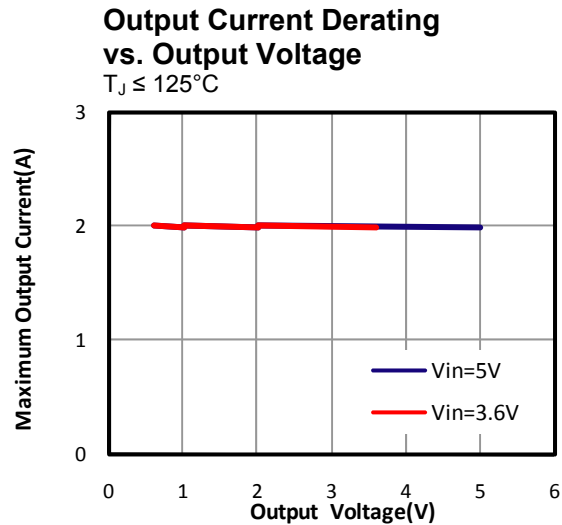
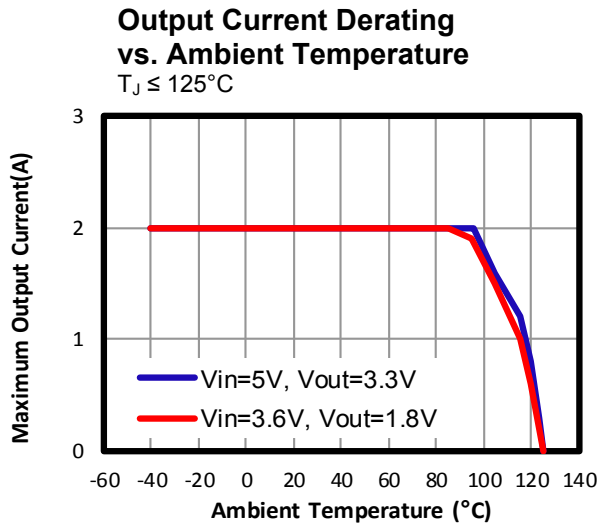
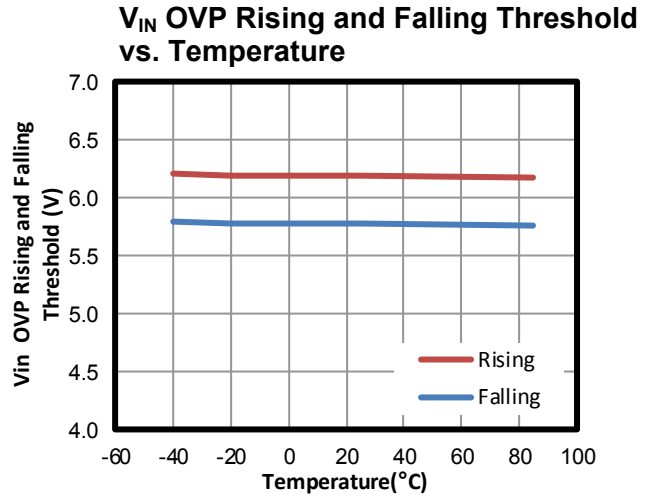
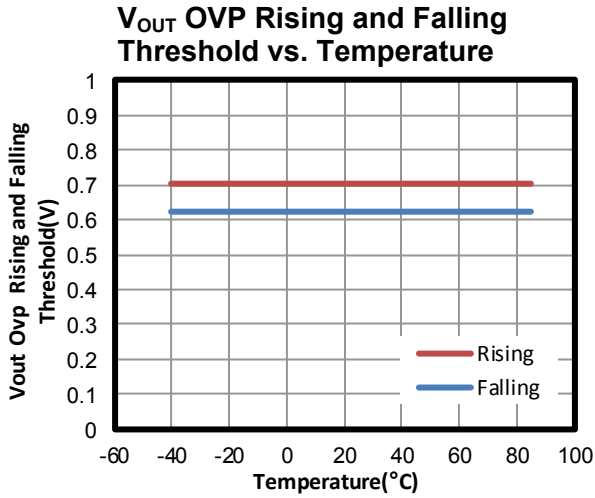
EN Rising and Falling Threshold vs. Temperature

V_{IN} Rising and Falling Threshold vs. Temperature

Switching Frequency vs. Temperature

Reference Voltage vs. Temperature

TYPICAL CHARACTERISTICS (continued)

 V_{IN} = 3.6V, V_{OUT} = 1.2V, L = 1 μ H, C_{OUT} = 22 μ F, T_A = +25 $^{\circ}$ C, unless otherwise noted.

TYPICAL PERFORMANCE CHARACTERISTICS

V_{IN} = 5V, V_{OUT} = 1.2V, L = 1 μ H, C_{OUT} = 22 μ F, T_A = +25°C, unless otherwise noted.

Steady State

I_{OUT} = 0A

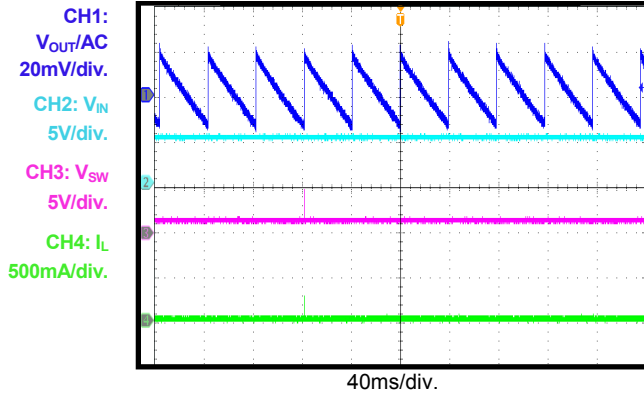

Steady State

I_{OUT} = 2A

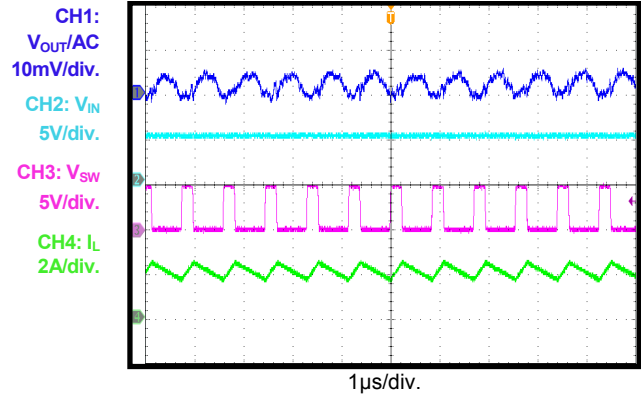

V_{IN} Power-Up

I_{OUT} = 0A

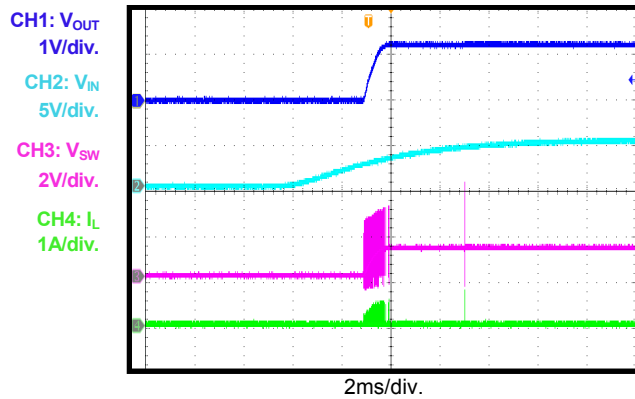

V_{IN} Power-Up

I_{OUT} = 2A

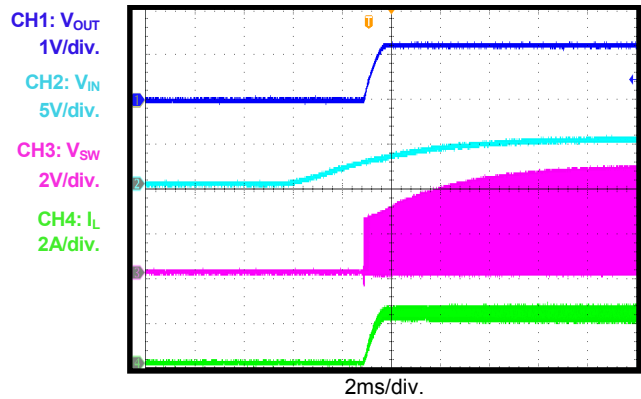

V_{IN} Shutdown

I_{OUT} = 0A

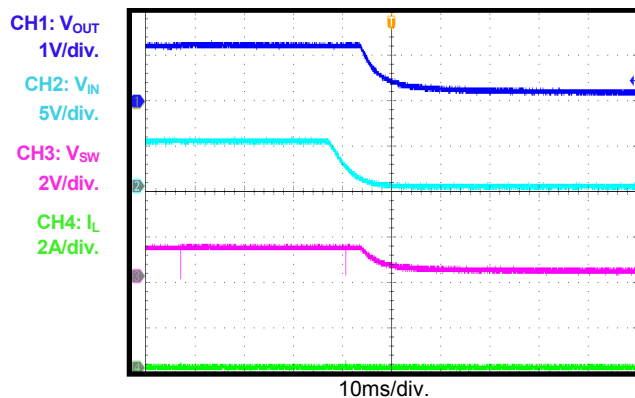

V_{IN} Shutdown

I_{OUT} = 2A

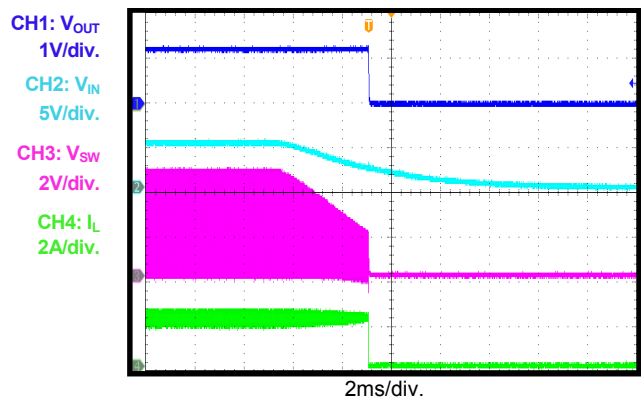

TYPICAL PERFORMANCE CHARACTERISTICS (continued)

 V_{IN} = 5V, V_{OUT} = 1.2V, L = 1 μ H, C_{OUT} = 22 μ F, T_A = +25°C, unless otherwise noted.

EN Power-Up

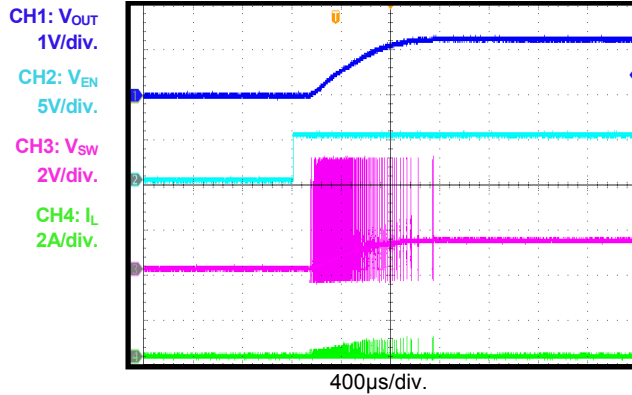
 I_{OUT} = 0A

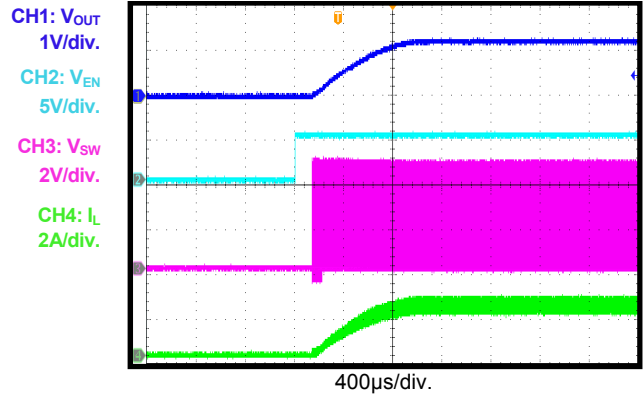
EN Power-Up

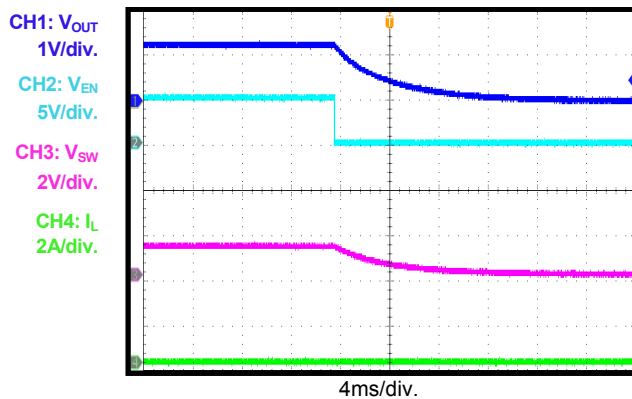
 I_{OUT} = 2A

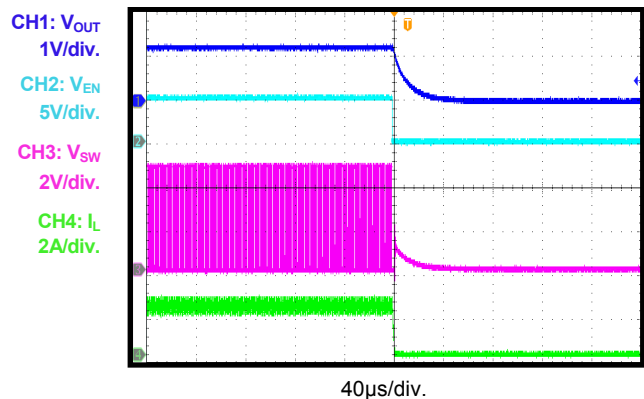
EN Shutdown

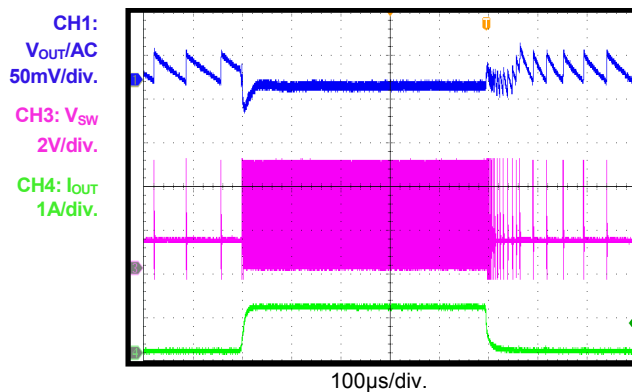
 I_{OUT} = 0A

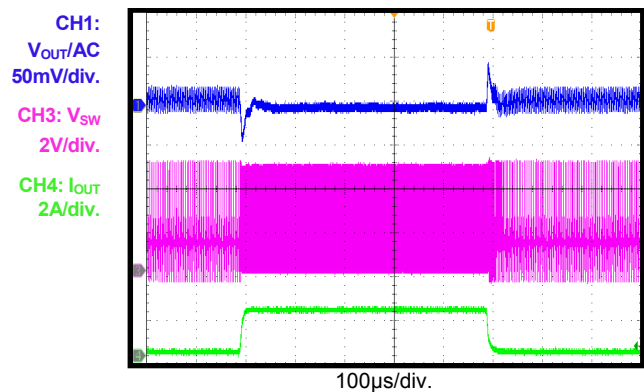
EN Shutdown

 I_{OUT} = 2A

Load Transient

 I_{OUT} = 0 - 1A, 1A/ μ s

Load Transient

 I_{OUT} = 0.1 - 2A, 1A/ μ s

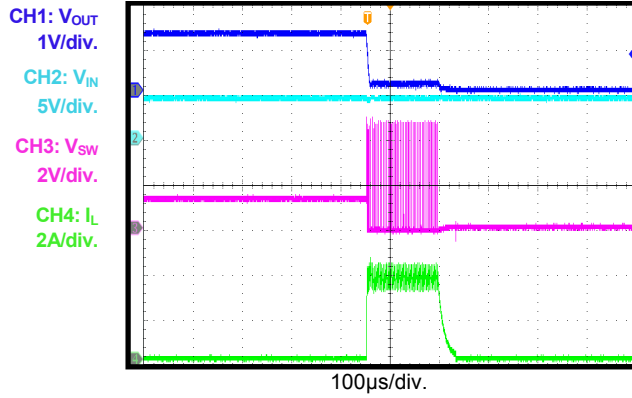
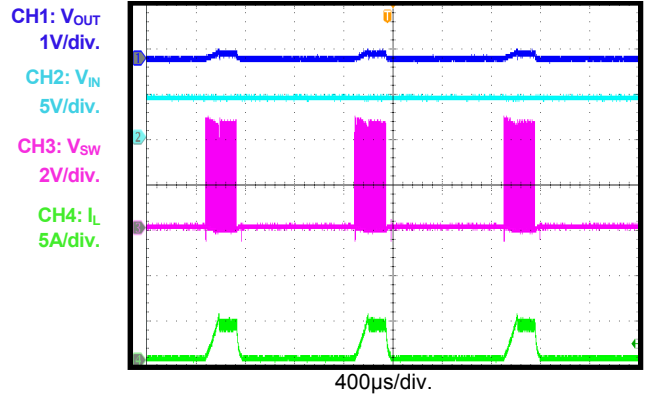
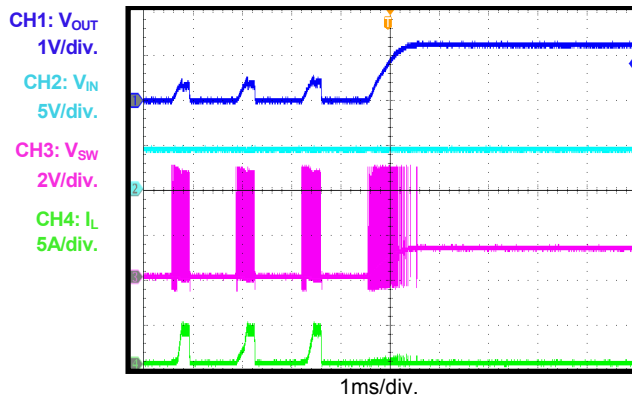
TYPICAL PERFORMANCE CHARACTERISTICS (continued)

 V_{IN} = 5V, V_{OUT} = 1.2V, L = 1 μ H, C_{OUT} = 22 μ F, T_A = +25°C, unless otherwise noted.

Short-Circuit Entry

Short-Circuit State

Short-Circuit Recovery

PIN FUNCTIONS

Pin #	Name		Description
	Adj	Fixed	
1	GND	GND	Power ground.
2	SW	SW	Output switching node. SW is the drain of the internal high-side P-channel MOSFET. Connect the inductor to SW to complete the converter.
3	VIN	VIN	Supply voltage. The MP2152A operates from a +2.5V to +5.5V unregulated input. A decoupling capacitor is needed to prevent large voltage spikes from appearing at the input.
4	EN	EN	On/off control.
5	FB	-	Feedback. An external resistor divider from the output to GND tapped to FB sets the output voltage.
	-	PG	Power good indicator. The output of PG is an open drain with an external pull-up resistor to VIN.
6	OUT	OUT	Output sense. OUT is the voltage power rail and input sense for the output voltage. Connect the load to OUT. An output capacitor is needed to decrease the output voltage ripple.

BLOCK DIAGRAM

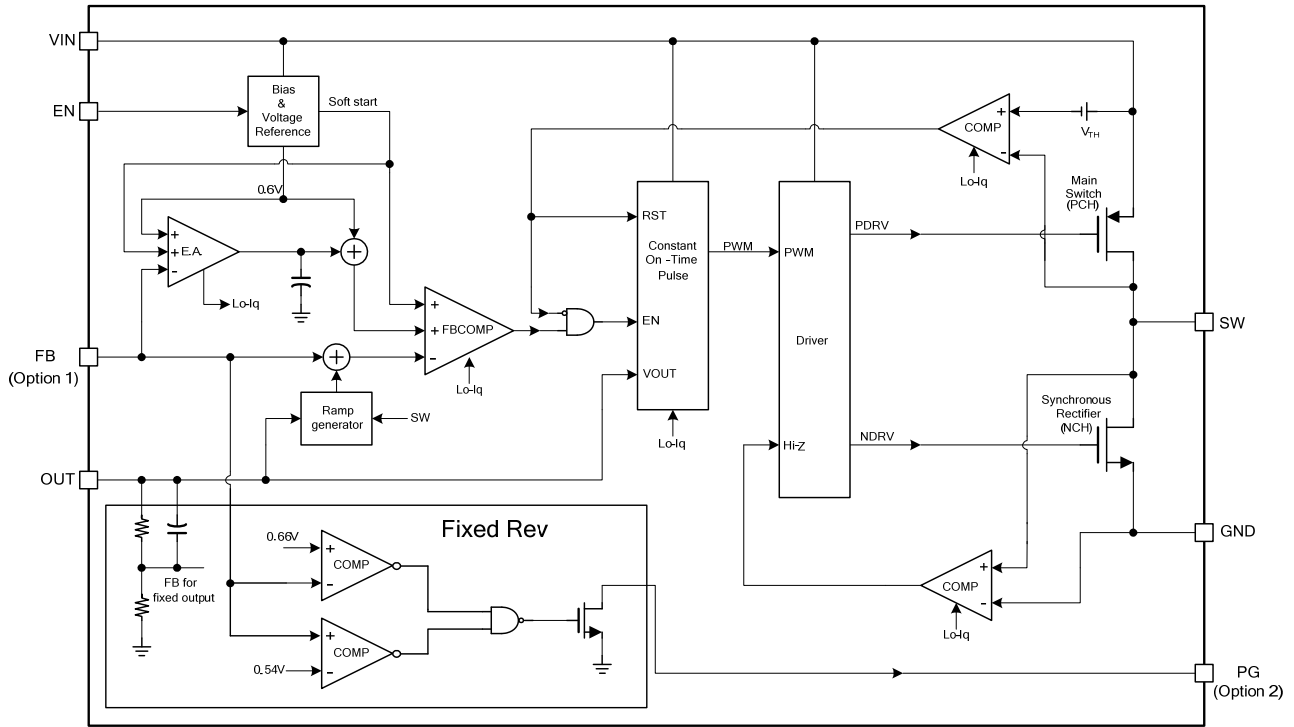

Figure 1: Functional Block Diagram

NOTE: Option 1: FB is only for MP2152AXXX
 Option 2: PG is only for MP2152AXXX-XX

OPERATION

The MP2152A uses constant-on-time (COT) control with input voltage feed-forward to stabilize the switching frequency over the entire input range. The MP2152A achieves 2A of continuous output current from a 2.5V to 5.5V input voltage with excellent load and line regulation. The output voltage can be regulated as low as 0.6V.

Constant-On-Time (COT) Control

Compared to fixed-frequency pulse-width modulation (PWM) control, constant-on-time (COT) control offers a simpler control loop and faster transient response. By using input voltage feed-forward, the MP2152A maintains a nearly constant switching frequency across the input and output voltage ranges. The switching pulse on time can be estimated with Equation (1):

$$T_{ON} = \frac{V_{OUT}}{V_{IN}} \cdot 0.91\mu s \quad (1)$$

To prevent inductor current runaway during the load transient, the MP2152A has a fixed minimum off time of 100ns.

Sleep Mode Operation

The MP2152A features sleep mode to achieve high efficiency at extremely light loads. In sleep mode, most of the circuit blocks are turned off except for the error amplifier and PWM comparator, reducing the operation current to a minimal value (see Figure 2).

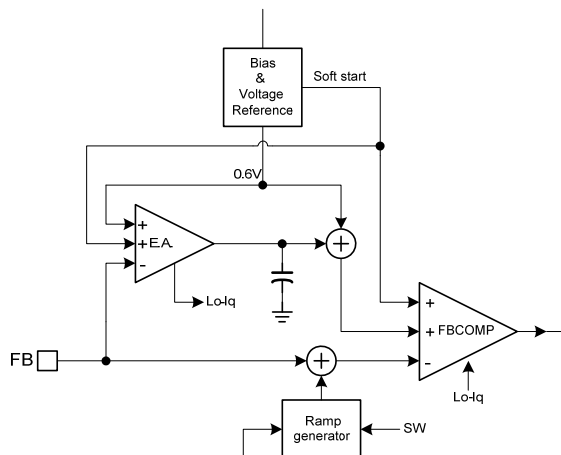

Figure 2: Operation Blocks at Sleep Mode

When the loading becomes lighter, the ripple of the output voltage becomes larger and drives the error amplifier output (EAO) lower. When the EAO reaches the internal low threshold, it is clamped at that level, and the MP2152A enters sleep mode. During sleep mode, the valley of the FB voltage is regulated to the internal reference voltage, making the average output voltage slightly higher than the output voltage at discontinuous conduction mode (DCM) or continuous conduction mode (CCM). The on-time pulse at sleep mode is slightly larger than that in DCM or CCM. Figure 3 shows the average FB voltage's relationship with the internal reference at sleep mode.

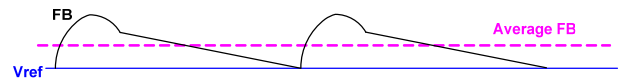

Figure 3: FB Average Voltage at Sleep Mode

When the MP2152A is in sleep mode, the average output voltage is higher than the internal reference voltage. The EAO is kept low and clamped in sleep mode. When the load increases, the PWM switching period decreases to keep the output voltage regulated, and the output voltage ripple decreases relatively. Once the EAO is higher than the internal low threshold, the MP2152A exits sleep mode and enters DCM or CCM depending on the load. In DCM or CCM, the EA regulates the average output voltage to the internal reference (see Figure 4).

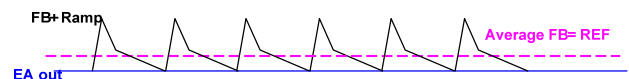

Figure 4: DCM Control

There is always a loading hysteresis when entering and exiting sleep mode due to the error amplifier clamping response time.

AAM Operation at Light-Load Operation

The MP2152A uses advanced asynchronous mode (AAM) power-save mode together with a zero-current cross detection (ZCD) circuit for light-load operation.

The MP2152A uses AAM power-save mode for light load (see Figure 5). The AAM current (I_{AAM}) is set internally. The SW on-pulse time is decided by the on-time generator and AAM comparator. In light-load condition, the SW on-

pulse time is the longer pulse. If the AAM comparator pulse is longer than the on-time generator, the operation mode is as shown in Figure 6.

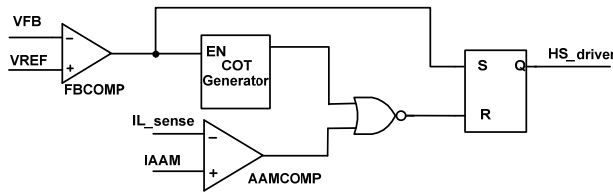

Figure 5: Simplified AAM Control Logic

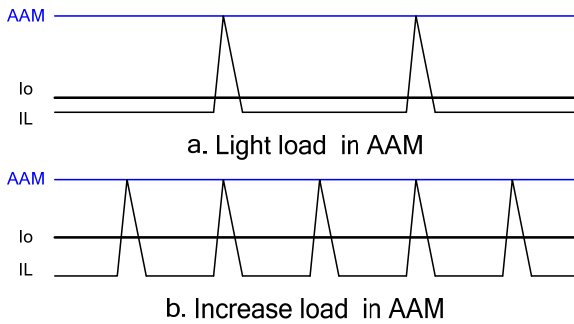

Figure 6: AAM Comparator Control T_{ON}

If the AAM comparator pulse is shorter than the on-time generator, the operation mode is as shown in Figure 7.

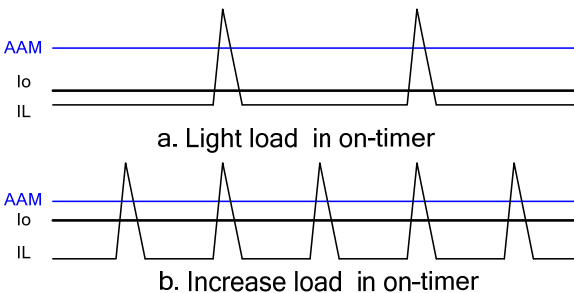

Figure 7: On-Time Control T_{ON}

Figure 8 shows the AAM threshold decreasing as T_{ON} increases gradually. For CCM, I_o must be more than half of the AAM threshold at least. Generally, the AAM threshold is lower than the inductor current at normal duty cycles.

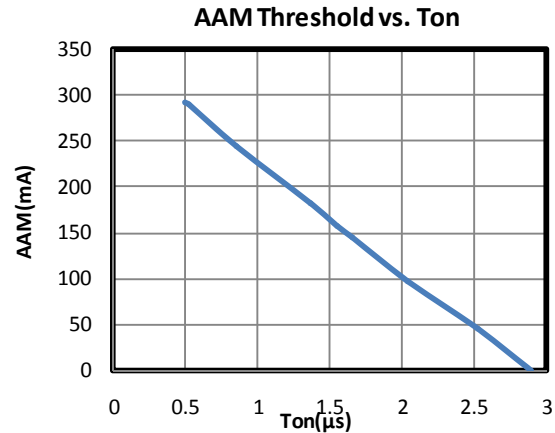

Figure 8: AAM Threshold Decreases as T_{ON} Increases

The MP2152A uses a ZCD to determine if the inductor current has started reversing. When the inductor current reaches the ZCD threshold, the low-side switch turns off.

AAM together with a ZCD circuit makes the MP2152A always work in DCM at light load, even if V_{OUT} is close to V_{IN}.

Enable (EN)

If the input voltage is greater than the under-voltage lockout (UVLO) threshold (typically 2.3V), the MP2152A can be enabled by pulling EN higher than 1.2V. Leave EN floating or pull EN down to ground to disable the MP2152A. There is an internal 1M Ω resistor from EN to ground.

When the device is disabled, the MP2152A enters output discharge mode automatically. Its internal discharge MOSFET provides a resistive discharge path for the output capacitor.

Soft Start (SS)

The MP2152A has a built-in soft start that ramps up the output voltage at a controlled slew rate to avoid overshooting at start-up. The soft-start time is about 0.5ms, typically.

Current Limit

The MP2152A has a typical minimum 2.8A high-side switch current limit. When the high-side switch reaches its current limit, the MP2152A remains in hiccup mode until the current drops. This prevents the inductor current from continuing to rise and damaging components.

Short Circuit and Recovery

The MP2152A enters short-circuit protection (SCP) mode when it reaches its current limit and attempts to recover with hiccup mode. The MP2152A disables the output power stage, discharges the soft-start capacitor, and attempts to soft start again automatically. If the short-circuit condition remains after the soft start ends, the MP2152A repeats this cycle until the short circuit is removed and the output rises back to the regulation level.

Over-Voltage Protection (V_{OUT} OVP)

The MP2152A monitors the feedback voltage to detect over-voltage. When the feedback voltage becomes higher than 115% of the target voltage, the controller enters a dynamic regulation period. During this period, the low-side turns on until the low-side current drops to -1.5A. This discharges the output to keep it within the normal range. If the over-voltage condition still remains, the low-side turns on again after a 1 μ s delay. The MP2152A exits this regulation period when the feedback voltage decreases below 105% of the reference voltage. If the dynamic regulation cannot limit the increasing V_{OUT}, once the input detects the 6.1V input, over-voltage protection (OVP) occurs, the MP2152A stops switching until the input voltage drops below 5.7V, and then the MP2152A resumes operation.

APPLICATION INFORMATION

Setting the Output Voltage

The external resistor divider sets the output voltage (see the Typical Application on page 20). Select a feedback resistor (R1) value to reduce the V_{OUT} leakage current, typically between 100 - 200kΩ. There is no strict requirement on the feedback resistor. An R1 value greater than 10kΩ is reasonable for applications. R2 can then be calculated with Equation (2):

$$R2 = \frac{R1}{\frac{V_{out}}{0.6} - 1} \quad (2)$$

Figure 9 shows the feedback circuit.

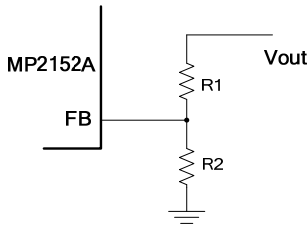

Figure 9: Feedback Network

Table 1 lists the recommended resistor values for common output voltages.

Table 1: Resistor Values for Common Output Voltages

V _{OUT} (V)	R1 (kΩ)	R2 (kΩ)
1.0	200 (1%)	300 (1%)
1.2	200 (1%)	200 (1%)
1.8	200 (1%)	100 (1%)
2.5	200 (1%)	63.2 (1%)
3.3	200 (1%)	44.2 (1%)

Selecting the Inductor

Most applications work best with a 1 - 2.2µH inductor. Select an inductor with a DC resistance less than 50mΩ to optimize efficiency.

A high-frequency switch-mode power supply with a magnetic device has strong electronic magnetic inference. Any unshielded power inductors should be avoided. Metal alloy or multilayer chip power inductors are ideal shielded inductors since they can decrease the influence effectively.

Table 2 lists some recommended inductors.

Table 2: Suggested Inductor List

Manufacturer P/N	Inductance (µH)	Manufacturer
PIFE25201B-1R0MS	1.0	CYNTEC CO. LTD.
74437324010	1.0	Würth

For most designs, estimate the inductance value with Equation (3):

$$L_1 = \frac{V_{OUT} \times (V_{IN} - V_{OUT})}{V_{IN} \times \Delta I_L \times f_{OSC}} \quad (3)$$

Where ΔI_L is the inductor ripple current.

Choose the inductor current to be approximately 30% of the maximum load current. The maximum inductor peak current can be calculated with Equation (4):

$$I_{L(MAX)} = I_{LOAD} + \frac{\Delta I_L}{2} \quad (4)$$

Selecting the Input Capacitor

The input current to the step-down converter is discontinuous and therefore requires a capacitor to supply AC current to the step-down converter while maintaining the DC input voltage. Use low ESR capacitors for the best performance. Ceramic capacitors with X5R or X7R dielectrics are highly recommended because of their low ESR and small temperature coefficients. For most applications, a 22µF capacitor is sufficient. Higher output voltages may require a 44µF capacitor to increase system stability.

The input capacitor requires an adequate ripple current rating since it absorbs the input switching current. Estimate the RMS current in the input capacitor with Equation (5):

$$I_{C1} = I_{LOAD} \times \sqrt{\frac{V_{OUT}}{V_{IN}} \times \left(1 - \frac{V_{OUT}}{V_{IN}}\right)} \quad (5)$$

The worst-case scenario occurs at V_{IN} = 2V_{OUT}, shown in Equation (6):

$$I_{C1} = \frac{I_{LOAD}}{2} \quad (6)$$

For simplification, choose an input capacitor with an RMS current rating greater than half of the maximum load current.

The input capacitor can be electrolytic, tantalum, or ceramic. When using electrolytic or tantalum capacitors, add a small, high-quality, 0.1μF ceramic capacitor as close to the IC as possible. When using ceramic capacitors, ensure that they have enough capacitance to provide a sufficient charge to prevent excessive voltage ripple at the input. The input voltage ripple caused by the capacitance can be estimated with Equation (7):

$$\Delta V_{IN} = \frac{I_{LOAD}}{f_s \times C1} \times \frac{V_{OUT}}{V_{IN}} \times \left(1 - \frac{V_{OUT}}{V_{IN}}\right) \quad (7)$$

Selecting the Output Capacitor

The output capacitor (C2) stabilizes the DC output voltage. Low ESR ceramic capacitors are recommended to limit the output voltage ripple. Estimate the output voltage ripple with Equation (8):

$$\Delta V_{OUT} = \frac{V_{OUT}}{f_s \times L_1} \times \left(1 - \frac{V_{OUT}}{V_{IN}}\right) \times \left(R_{ESR} + \frac{1}{8 \times f_s \times C2}\right) \quad (8)$$

Where L₁ is the inductor value, and R_{ESR} is the equivalent series resistance (ESR) value of the output capacitor.

When using ceramic capacitors, the capacitance dominates the impedance at the switching frequency and causes most of the output voltage ripple. For simplification, the output voltage ripple can be estimated with Equation (9):

$$\Delta V_{OUT} = \frac{V_{OUT}}{8 \times f_s^2 \times L_1 \times C2} \times \left(1 - \frac{V_{OUT}}{V_{IN}}\right) \quad (9)$$

For tantalum or electrolytic capacitors, the ESR dominates the impedance at the switching frequency. For simplification, the output ripple can be approximated with Equation (10):

$$\Delta V_{OUT} = \frac{V_{OUT}}{f_s \times L_1} \times \left(1 - \frac{V_{OUT}}{V_{IN}}\right) \times R_{ESR} \quad (10)$$

The characteristics of the output capacitor also affect the stability of the regulation system.

PCB Layout Guidelines

Efficient PCB layout of the switching power supplies is critical for stable operation. For the high-frequency switching converter, a poor layout design can result in poor line or load regulation and stability issues. For best results, refer to Figure 10 and follow the guidelines below.

1. Place the high-current paths (GND, VIN, and SW) very close to the device with short, direct, and wide traces.
2. Place the input capacitor as close to VIN and GND as possible.
3. Place the external feedback resistors next to FB.
4. Keep the switching node (SW) short and away from the feedback network.
5. Keep the V_{OUT} sense line need as short as possible and away from the power inductor, especially the surrounding inductor.

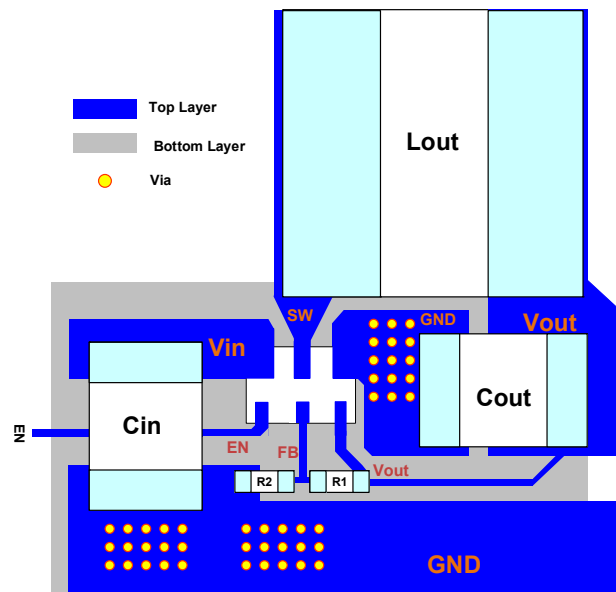

Figure 10: Recommended Layout for the MP2152AQFU

TYPICAL APPLICATION CIRCUITS

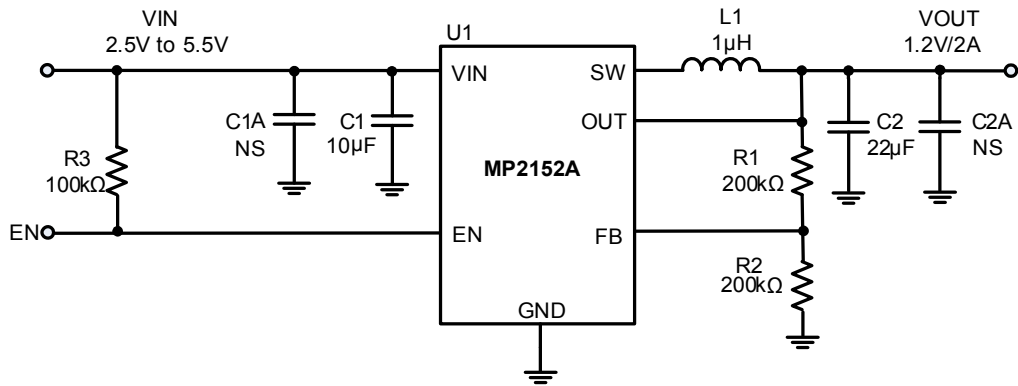

Figure 11: Typical Application Circuit for MP2152A

NOTE: VIN < 3.3V may require more input capacitors.

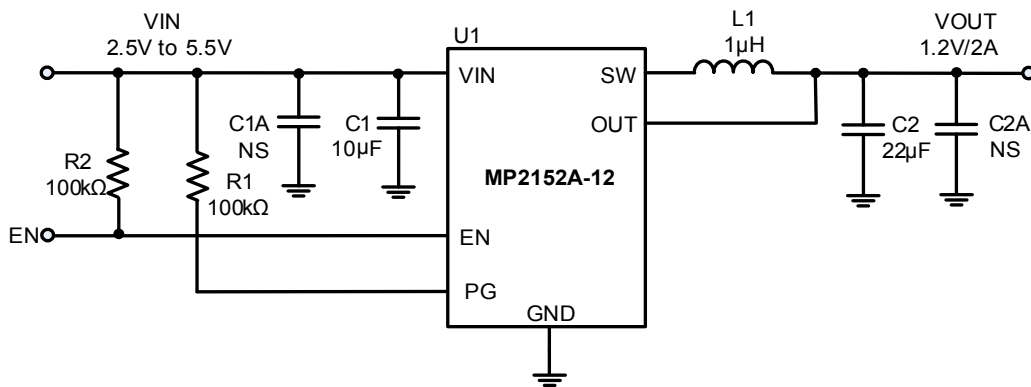
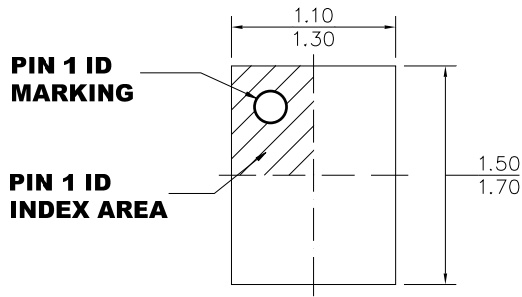

Figure 12: Typical Application Circuit for MP2152A-12

NOTE: VIN < 3.3V may require more input capacitors.

PACKAGE INFORMATION

UTQFN (1.2mmx1.6mm)



TOP VIEW

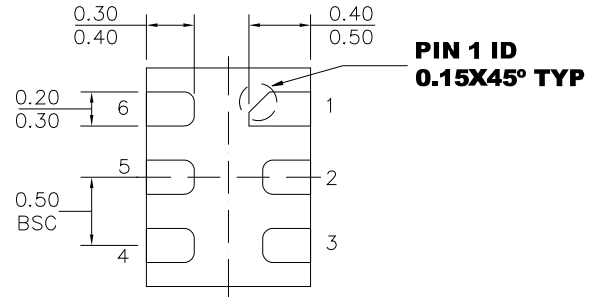

BOTTOM VIEW

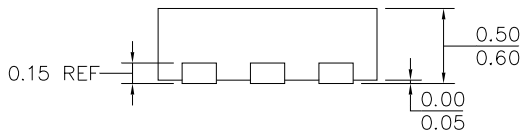

SIDE VIEW

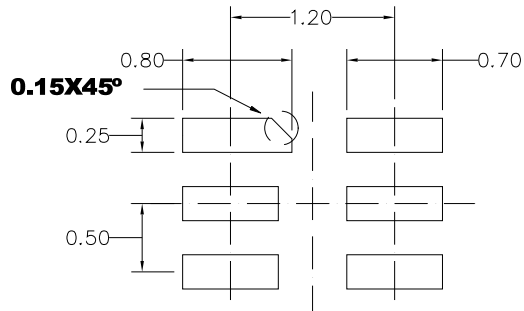

RECOMMENDED LAND PATTERN

NOTE:

- 1) ALL DIMENSIONS ARE IN MILLIMETERS.
- 2) LEAD COPLANARITY SHALL BE 0.08 MILLIMETERS MAX.
- 3) JEDEC REFERENCE IS MO-220.
- 4) DRAWING IS NOT TO SCALE.

NOTICE: The information in this document is subject to change without notice. Please contact MPS for current specifications. Users should warrant and guarantee that third party Intellectual Property rights are not infringed upon when integrating MPS products into any application. MPS will not assume any legal responsibility for any said applications.