

## DESCRIPTION

The **MMP757094-36** is part of a family of smart motor control boards for servo motor applications. This design is capable of delivering 94W continuous power and is designed to fit NEMA 23 format 57mm motors.

The board features an:

- Embedded angular sensor,
- FOC control
- Selectable position, speed and torque loop mode
- RS485 and PULSE/DIR input interface.

The user can choose from three options: speed control mode, position control mode, or speed/position control mode.

An easy-to-use GUI software allows users to flexibly optimize the design online through the RS485 control interface. The parameters are saved in the control boards non-volatile memory.

User can also order a complete motor (**MSM957094-36**). A datasheet for the MSM957094-36 is available for download at [www.monolithicpower.com](http://www.monolithicpower.com).



**Motor Control PCBA**

Motor Control Board			
Parameters	Condition	Value	Units
Input Voltage		36	V
Output Power	0°C - 40°C	94	W
Position Resolution		0.3	°

## FEATURES

- 18V To 70V Input Voltage Range
- Max. 94W Continuous Power Output
- 0.3° Position Resolution
- RS485 Interface and PULSE/DIR Interface
- Position Control and speed control
- Operating Temperature: 0°C - 70°C (Power Derated > 40°C)
- Storage Temperature: -40°C - 125°C

## ORDERING INFORMATION

Part Number	Diameter (mm)	Power (W)	Typical Voltage (V)	Control Mode	Interface
MMP757094-36-C	57	94	36	Speed /Position	RS485 Pul/Dir

## RECOMMENDED OPERATING CONDITIONS

Input Voltage ..... 18V – 70V  
 Control Interface Voltage ..... 0V–5.5V  
 Max. Pulse Frequency ..... 500KHZ  
 RS485 A/B Voltage ..... 0V–5.5V  
 RS485 Common Mode Voltage ..... +/-15V  
 Operation Temperature..... 0°C - 70°C  
 Storage Temperature..... -40°C - 125°C

INSTALLATION OF PCB ASSEMBLY IN SMART MOTOR

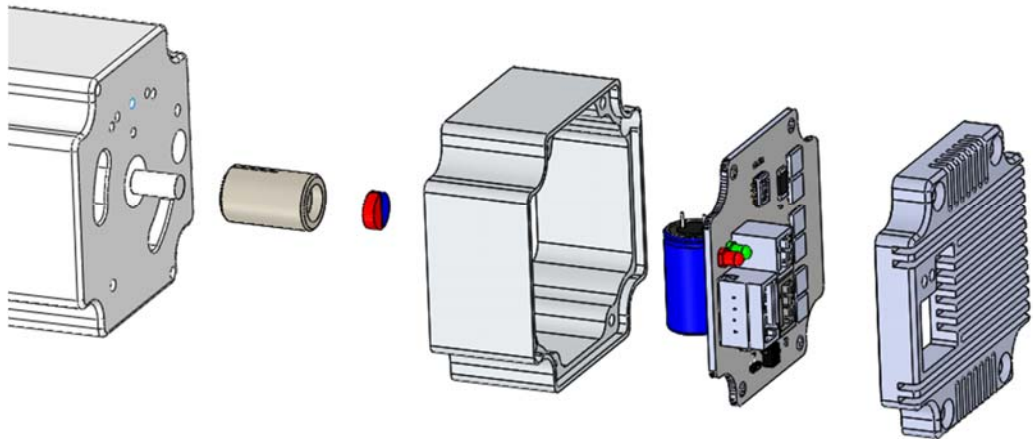

The motor control PCB assembly can be installed into a motor as illustrated in the figure above. The user can manufacture their own control board housing and magnet holder based on the actual motor dimension. MPS will supply the magnet to the user.

Some examples or recommended magnets for use with the MMP module are shown in the table below. A sintered NdFeB or SmCo magnet of diameter 6 or 8 mm and height 2.5 to 3mm with remanent field strength in the range 1.0 to 1.2 T is suggested. The diameter of magnet will depend on the specific motor shaft and holder design used. It is important that the magnetization is diametrically polarized.

The magnet airgap spacing to the sensor surface should be set to achieve a field strength in the range of 30mT min to 80mT max. The MPS magnetic simulation tool at <http://sensors.monolithicpower.com/> can be used to find the correct airgap spacing's for the particular magnet used.

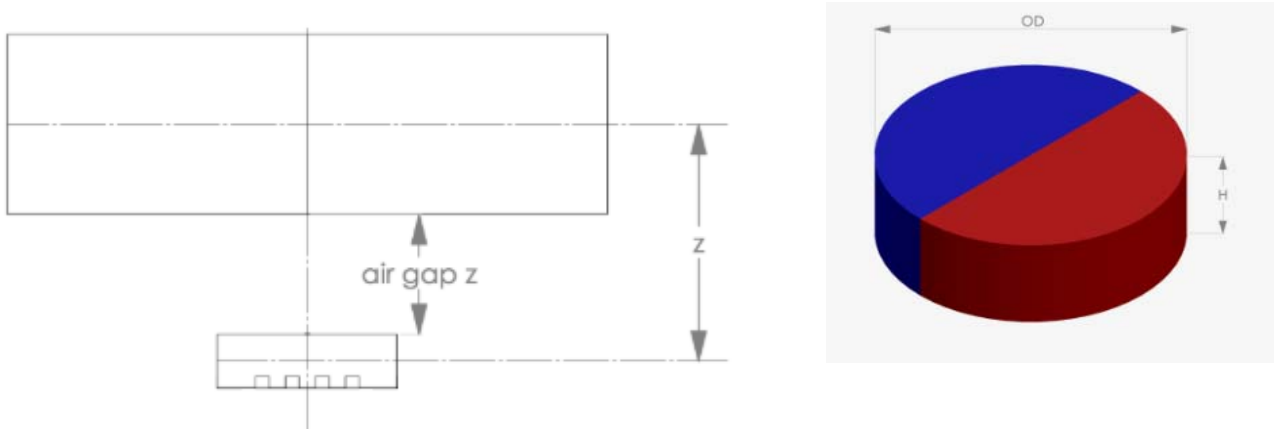

For the magnets suggested in the table below, the recommended minimum and maximum airgap spacing is shown.

OD (mm)	H (mm)	Material	Remanence (Br) (T)	Magnetization	Recommended "air gap z" mm min/max
6.0	2.5	N35	1.2	Diametrical	1.5 to 3.5
6.0	2.5	Sm26/16	1.08	Diametrical	1.3 to 3.3
6.0	3.0	N35	1.2	Diametrical	1.8 to 3.8
6.0	3.0	Sm26/16	1.08	Diametrical	1.5 to 3.6
8.0	2.5	N35	1.2	Diametrical	1.8 to 4.5
8.0	2.5	Sm26/16	1.08	Diametrical	1.5 to 4.1
8.0	3.0	N35	1.2	Diametrical	2.1 to 4.8
8.0	3.0	Sm26/16	1.08	Diametrical	1.8 to 4.5

The choice of Neodymium or Samarium Cobalt material depends on the target motor end application. Samarium Cobalt magnets have a higher working temperature range and higher corrosion resistance.

The choice of holder material is important. It should be of a nonmagnetic material such as aluminum, brass, or plastic so as not to influence or distort the sensor magnets field. The choice of attachment method to the shaft is left to the user to determine based on the design criteria for the motor. To avoid detachment due to the different coefficients of thermal expansion for magnet, holder and shaft, the use of a high temperature industrial adhesive is one possible approach.

The magnet holder requires a motor with a shaft that extends from the rear of the motor. Contact your individual motor supplier to discuss what options they have for shaft diameter and length. This will determine the holder size and housing depth required.

The PCB housing should be designed to take into account any heatsinking requirements for the motor driver components, additional bulk motor supply capacitance and EMC filtering as may be required to meet the target application specifications. The housing should center the central angle sensor IC to align to the motor shaft magnet holder with no more than +/-0.4mm of axial misalignment.

HARDWARE CONNECTION FOR PROGRAMMING SMART MOTOR

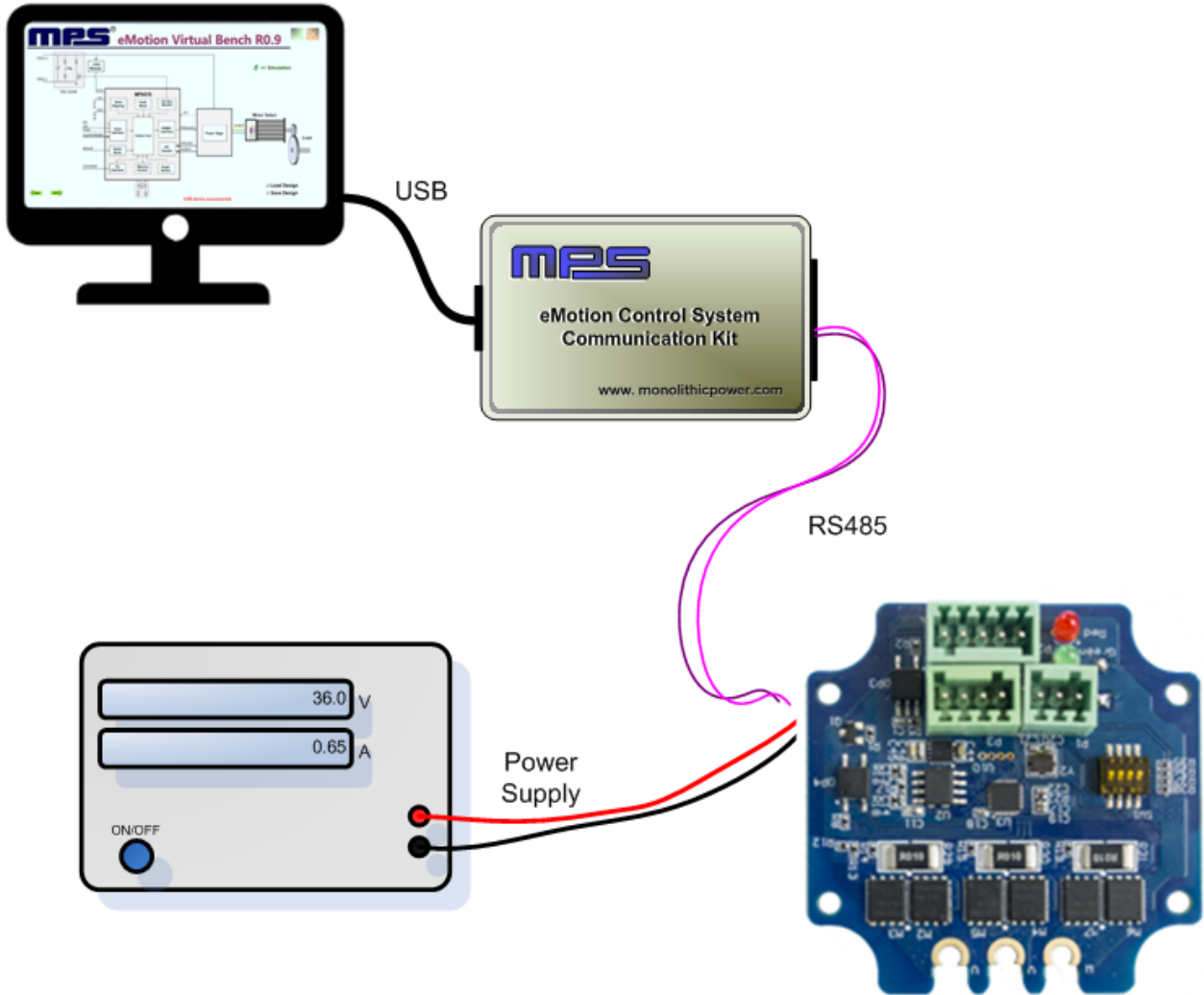

## PIN CONFIGURATION

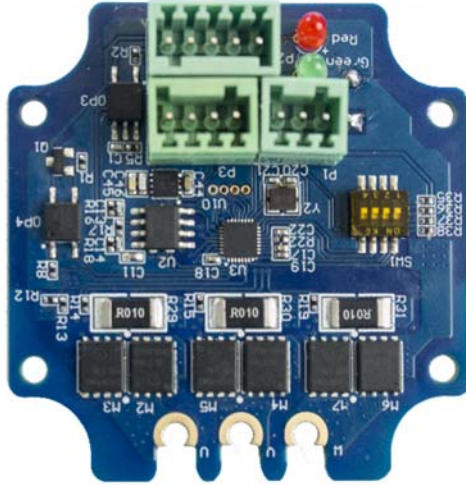
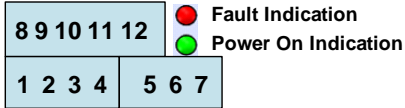

Pin Number	Designation	Pin Description
<b>RS485 Interface</b>		
1	EXT_5V	5V Input For Firmware Programming
2	B	RS485 Node B
3	AGND	RS485 Ground
4	A	RS485 Node A
<b>Power Interface</b>		
5	GND	Power Ground
6	R-	Shunt Resistor Return Node
7	VIN	Input Power Supply
<b>Control Interface</b>		
8	COM-	Common Return
9	EN+	Enable Input
10	PEND+	Position End Output
11	PUL+	Pulse Input
12	DIR+	Direction Input

TYPICAL PERFORMANCE CHARACTERISTICS

T<sub>a</sub>=25°C, VIN=36V, unless otherwise noted

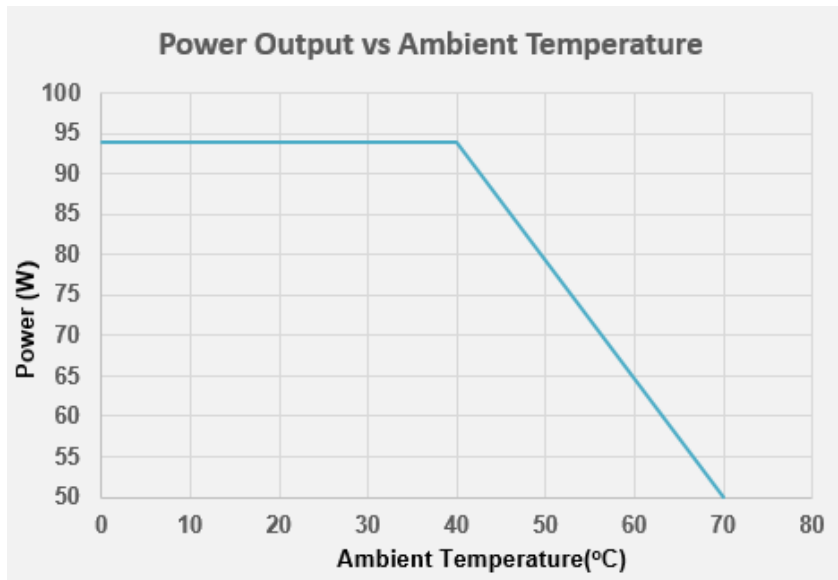

DRIVER MODUE MECHANICAL DRAWING

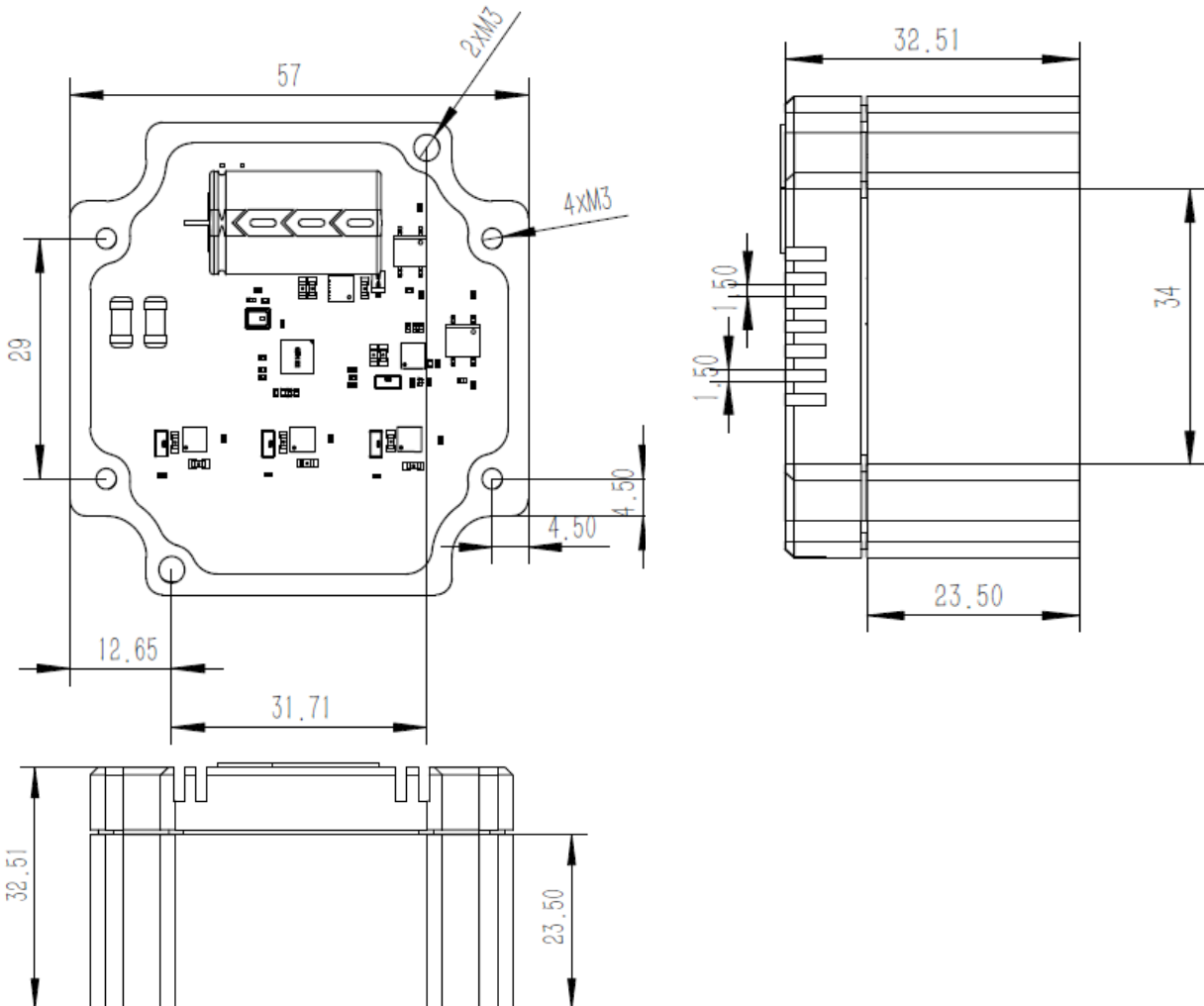

Note that no housing is supplied with the MMP75094 PCB.

The above drawings are for illustration only, and are based on dimensions for a NEMA 23 format motor.

Contact your individual motor supplier for the particular mounting hole positions and dimension information.

**NOTICE:** The information in this document is subject to change without notice. Users should warrant and guarantee that third party Intellectual Property rights are not infringed upon when integrating MPS products into any application. MPS will not assume any legal responsibility for any said applications.