

**PRELIMINARY SPECIFICATIONS SUBJECT TO CHANGE**

### DESCRIPTION

The MCS1803 is a Hall effect-based linear current sensor IC for AC or DC current sensing. The Hall array is differential to cancel out any stray magnetic field.

A low resistance primary conductor allows current flow within close proximity of an integrated circuit containing high accuracy Hall sensors. This current generates a magnetic field which is sensed at two different points by the integrated Hall transducers. The magnetic field difference between these two points is then converted into a voltage proportional to the applied current. Spinning current technique is used for a low stable offset.

The galvanic isolation between the pins of the primary conductive path and the sensor leads allows the MCS1803 to replace opto-isolators or other expensive isolation devices.

The MCS1803 requires a minimum number of readily available, standard external components. It is available in a SOIC-8 package. The small footprint saves board area and is ideal for space-constrained applications.

### FEATURES

- 5V single supply
- Immune to external magnetic fields by differential sensing
- 2.4 kVRMS minimum isolation voltage from pins 1-4 to pins 5-8
- Operating temperature -40°C to 125°C
- 0.9 mΩ internal conductor resistance
- 5 to 50 A range (see ordering information)
- Adjustable bandwidth, up to 100kHz
- 4μs output rise time
- Ratiometric output from supply voltage
- Output proportional to AC or DC currents
- Factory-trimmed for accuracy
- No magnetic hysteresis
- Integrated shield suppressing capacitive coupling from current conductor to die (up to 10V/ns)
- SOIC-8 package

### APPLICATIONS

- Motor control
- Automotive systems
- Load detection & management
- Switched-mode power supplies
- Over-current fault protection

All MPS parts are lead-free, halogen-free, and adhere to the RoHS directive. For MPS green status, please visit the MPS website under Quality Assurance. "MPS", the MPS logo, and "Simple, Easy Solutions" are trademarks of Monolithic Power Systems, Inc. or its subsidiaries.

### TYPICAL APPLICATION

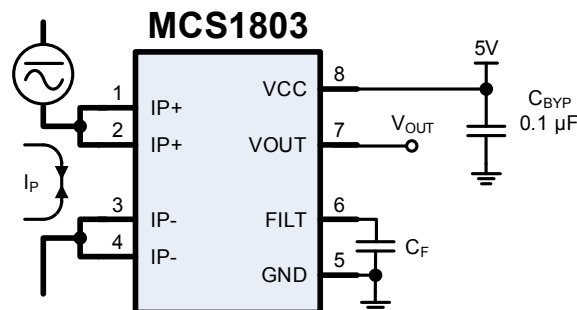

$V_{OUT}$  is proportional to  $I_P$  within the range specified. The noise vs bandwidth tradeoff can be adjusted by  $C_F$  connected between FILT and GND.



### ORDERING INFORMATION

Part Number*	Optimized Primary Current Range (A)	Typ. Sensitivity (Sens) (mV/A)	Top marking
MCS1803GS-05	±5	400	MC180305
MCS1803GS-10	±10	200	MC180310
MCS1803GS-20	±20	100	MC180320
MCS1803GS-30	±30	66	MC180330
MCS1803GS-40	±40	50	MC180340
MCS1803GS-50	±50	40	MC180350

\* For Tape & Reel, add suffix -Z (e.g.: MCS1803GS-05-Z).

### TOP MARKING (MCS1803GS-05)

**MC180305**

**LLLLLLLL**

**MPSYWW**

MC180305: Part number  
LLLLLLLL: Lot number  
MPS: MPS prefix  
Y: Year code  
WW: Week code

### TOP MARKING (MCS1803GS-10)

**MC180310**

**LLLLLLLL**

**MPSYWW**

MC180310: Part number  
LLLLLLLL: Lot number  
MPS: MPS prefix  
Y: Year code  
WW: Week code



**TOP MARKING (MCS1803GS-20)**

MC180320

LLLLLLLL

MPSYWW

MC180320: Part number

LLLLLLLL: Lot number

MPS: MPS prefix

Y: Year code

WW: Week code

**TOP MARKING (MCS1803GS-30)**

MC180330

LLLLLLLL

MPSYWW

MC180330: Part number

LLLLLLLL: Lot number

MPS: MPS prefix

Y: Year code

WW: Week code

**TOP MARKING (MCS1803GS-40)**

MC180340

LLLLLLLL

MPSYWW

MC180340: Part number

LLLLLLLL: Lot number

MPS: MPS prefix

Y: Year code

WW: Week code

**TOP MARKING (MCS1803GS-50)**

MC180350

LLLLLLLL

MPSYWW

MC180350: Part number  
 LLLLLLLL: Lot number  
 MPS: MPS prefix  
 Y: Year code  
 WW: Week code

**PACKAGE REFERENCE**

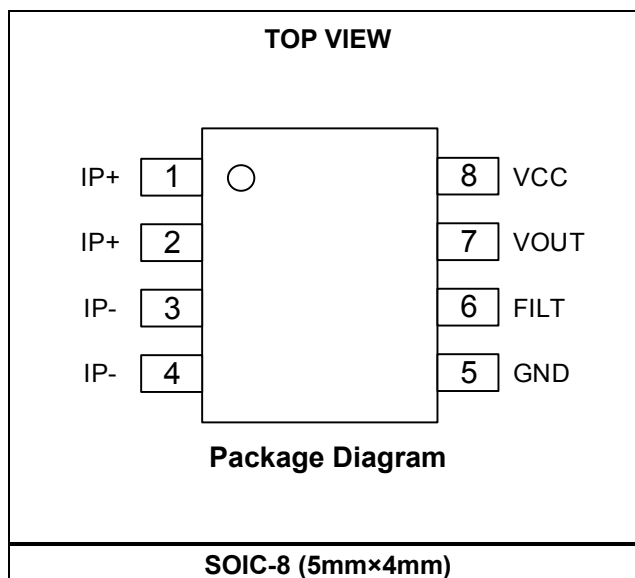

**PIN FUNCTIONS**

Package Pin #	Name	Description
1,2	IP+	<b>Primary current +</b> Terminals for current being sampled; fused internally.
3,4	IP-	<b>Primary current -</b> Terminals for current being sampled; fused internally.
5	GND	<b>Ground.</b> Signal ground terminal
6	FILT	<b>Filter.</b> Terminal for the external capacitor $C_F$ setting the bandwidth. Can be unconnected.
7	VOUT	<b>Analog output.</b>
8	VCC	<b>Voltage Supply.</b>



**ABSOLUTE MAXIMUM RATINGS** <sup>(1)</sup>

Supply Voltage VCC ..... -0.1V to 6V  
Output Voltage VOUT ..... -0.1V to 6V  
V<sub>FILT</sub> ..... -0.1V to 6V  
Junction Temperature ..... 165°C  
Lead Temperature ..... 260°C  
Storage Temperature ..... -65°C to +165°C

**ESD Rating**

PIN 6,7,8  
Human-body model (HBM) ..... ±2000V  
PIN 5,6,7,8  
Charge device model (CDM) ..... ±2000V

**Recommended Operating Conditions** <sup>(2)</sup>

Supply voltage (V<sub>IN</sub>) ..... 4.5V to 5.5V  
Operating junction temp. (T<sub>J</sub>) ..... -40°C to +125°C

**NOTES:**

- (1) Exceeding these ratings may damage the device.
- (2) The device is not guaranteed to function outside of its operating conditions.

**ISOLATION CHARACTERISTICS**

Parameters	Symbol	Condition	Rating	Units
Withstand Isolation Voltage	$V_{ISO}$	100% Production tested at $1.2 \times V_{ISO}$ for 1 second. Agency type-tested at $V_{ISO}$ for 60 seconds in accordance with UL157.	2400	$V_{RMS}$
Maximum isolation working voltage	$V_{IOWM}$	Maximum approved working voltage for basic (single) isolation according UL60950-1 (edition 2).	420	VDC or $V_{PK}$
			300	$V_{RMS}$
External Clearance	CLR	Shortest distance through air from IP leads to signal leads	4.2	mm
External Creepage	CPG	Shortest distance along package body from IP leads to signal leads	4.2	mm

**MCS1803 COMMON ELECTRICAL CHARACTERISTICS <sup>(3)</sup>**

 Typical values are VCC=5V, C<sub>F</sub>=0nF, C<sub>L</sub>=1nF, T<sub>J</sub>=-40°C to +125°C, unless otherwise noted.

Parameters	Symbol	Condition	Min	Typ	Max	Units
Supply Voltage	VCC		4.5		5.5	V
VCC Under-voltage Lockout Threshold	VCC <sub>UVLO</sub>	VCC falling	2	2.5	3	V
VCC Under-voltage Lockout Hysteresis	VCC <sub>UVLO</sub> <sub>_HYS</sub>			400	750	mV
Operating Supply Current	I <sub>CC</sub>	VCC=5V		8.5	10.5	mA
Output Capacitance Load <sup>(9)</sup>	C <sub>L</sub>	From VOUT to GND			10	nF
Output Resistive Load <sup>(9)</sup>	R <sub>L</sub>	From VOUT to GND	4.7			kΩ
Primary Conductor Resistance	R <sub>P</sub>	Effective		0.9		mΩ
Frequency Bandwidth <sup>(9)</sup>	f <sub>BW</sub>	FILT unconnected		100		kHz
Internal Filter Resistance <sup>(9)</sup>	R <sub>Fi</sub>			1.5		kΩ
Internal Filter Capacitance <sup>(9)</sup>	C <sub>Fi</sub>			1		nF
Power-On Time <sup>(9)</sup>	t <sub>PO</sub>	I <sub>P</sub> =I <sub>P</sub> MAX, FILT unconnected		90		μs
Rise Time <sup>(9)</sup>	t <sub>r</sub>	I <sub>P</sub> =I <sub>P</sub> MAX, FILT unconnected		4		μs
Propagation Delay <sup>(9)</sup>	t <sub>pd</sub>	I <sub>P</sub> =I <sub>P</sub> MAX, FILT unconnected		1.5		μs
Response Time <sup>(9)</sup>	t <sub>RESPONSE</sub>	I <sub>P</sub> =I <sub>P</sub> MAX, FILT unconnected		5		μs
Noise Density <sup>(9)</sup>	I <sub>ND</sub>	Input referred noise density		200		μA <sub>(rms)</sub> /√Hz
Noise <sup>(9)</sup>	I <sub>N</sub>	Input referred, 1nF on FILT (60kHz Bandwidth)		50		mA <sub>(rms)</sub>
Nonlinearity <sup>(9)</sup>	E <sub>LIN</sub>	Over full range of I <sub>P</sub>		0.5		%
Ratiometry	K <sub>sens</sub>	VCC=4.5 to 5.5V	98	100	102	%
	K <sub>V0</sub>	VCC=4.5 to 5.5V, I <sub>P</sub> =0A	99	100	101	%
Zero Current Output Voltage	V <sub>OUT(Q)</sub> (I <sub>P</sub> =0)	I <sub>P</sub> =0A		VCC/2		V
First Hall Magnetic Coupling Factor <sup>(9)</sup>	P <sub>MCF1</sub>		1.1	1.2	1.3	mT/A
Second Hall Magnetic Coupling Factor <sup>(9)</sup>	P <sub>MCF2</sub>		0.60	0.65	0.70	mT/A
Hall Plate Matching <sup>(9)</sup>	M <sub>H</sub>			±1		%
Saturation Voltage <sup>(4)</sup>	V <sub>OUT(H)</sub>	R <sub>L</sub> =4.7kΩ, T <sub>J</sub> =25°C	VCC – 0.5			V
	V <sub>OUT(L)</sub>	R <sub>L</sub> =4.7kΩ, T <sub>J</sub> =25°C			0.5	V

**MCS1803-05 PERFORMANCE CHARACTERISTICS <sup>(3)</sup>**
**VCC=5V, C<sub>F</sub>=0nF, C<sub>L</sub>=1nF, T<sub>J</sub>=-40°C to +125°C, unless otherwise noted.**

Parameters	Symbol	Condition	Min	Typ <sup>(10)</sup>	Max	Units
Optimized Accuracy Range <sup>(5)</sup>	I <sub>P</sub>		-5		5	A
Sensitivity	Sens	-5A ≤ I <sub>P</sub> ≤ 5A, T <sub>J</sub> =25°C		400		mV/A
Sensitivity Error	E <sub>Sens</sub>	I <sub>P</sub> =5A, T <sub>J</sub> =25°C to 125°C	-2		2	%
		I <sub>P</sub> =5A, T <sub>J</sub> =-40°C to 25°C		±1.5		%
Offset Voltage <sup>(6)</sup>	V <sub>OE</sub>	I <sub>P</sub> =0A, T <sub>J</sub> =25°C to 125°C	-10		10	mV
		I <sub>P</sub> =0A, T <sub>J</sub> =-40°C to 25°C		±5		mV
Total Output Error <sup>(7)</sup>	E <sub>TOT</sub>	I <sub>P</sub> =5A, T <sub>J</sub> =25°C to 125°C	-2.5		2.5	%
		I <sub>P</sub> =5A, T <sub>J</sub> =-40°C to 25°C		±1.5		%
Sensitivity Error Lifetime Drift <sup>(9)</sup>	E <sub>Sens(D)</sub>			±1		%
Total Output Error Lifetime Drift <sup>(9)</sup>	E <sub>TOT(D)</sub>			±1		%

**MCS1803-10 PERFORMANCE CHARACTERISTICS <sup>(3)</sup>**
**VCC=5V, C<sub>F</sub>=0nF, C<sub>L</sub>=1nF, T<sub>J</sub>=-40°C to +125°C, unless otherwise noted.**

Parameters	Symbol	Condition	Min	Typ <sup>(10)</sup>	Max	Units
Optimized Accuracy Range <sup>(5)</sup>	I <sub>P</sub>		-10		10	A
Sensitivity	Sens	-10A ≤ I <sub>P</sub> ≤ 10A, T <sub>J</sub> =25°C		200		mV/A
Sensitivity Error	E <sub>Sens</sub>	I <sub>P</sub> =10A, T <sub>J</sub> =25°C to 125°C	-2.		2	%
		I <sub>P</sub> =10A, T <sub>J</sub> =-40°C to 25°C		±1.5		%
Offset Voltage <sup>(6)</sup>	V <sub>OE</sub>	I <sub>P</sub> =0A, T <sub>J</sub> =25°C to 125°C	-10		10	mV
		I <sub>P</sub> =0A, T <sub>J</sub> =-40°C to 25°C		±5		mV
Total Output Error <sup>(7)</sup>	E <sub>TOT</sub>	I <sub>P</sub> =10A, T <sub>J</sub> =25°C to 125°C	-2.5		2.5	%
		I <sub>P</sub> =10A, T <sub>J</sub> =-40°C to 25°C		±1.5		%
Sensitivity Error Lifetime Drift <sup>(9)</sup>	E <sub>Sens(D)</sub>			±1		%
Total Output Error Lifetime Drift <sup>(9)</sup>	E <sub>TOT(D)</sub>			±1		%



**MCS1803-20 PERFORMANCE CHARACTERISTICS <sup>(3)</sup>**
**VCC=5V, C<sub>F</sub>=0nF, C<sub>L</sub>=1nF, T<sub>J</sub>=-40°C to +125°C, unless otherwise noted.**

Parameters	Symbol	Condition	Min	Typ <sup>(10)</sup>	Max	Units
Optimized Accuracy Range <sup>(5)</sup>	I <sub>P</sub>		-20		20	A
Sensitivity	Sens	-20A ≤ I <sub>P</sub> ≤ 20A, T <sub>J</sub> =25°C		100		mV/A
Sensitivity Error	E <sub>Sens</sub>	I <sub>P</sub> =20A, T <sub>J</sub> =25°C to 125°C	-2		2	%
		I <sub>P</sub> =20A, T <sub>J</sub> =-40°C to 25°C		±1.5		%
Offset Voltage <sup>(6)</sup>	V <sub>OE</sub>	I <sub>P</sub> =0A, T <sub>J</sub> =25°C to 125°C	-10		10	mV
		I <sub>P</sub> =0A, T <sub>J</sub> =-40°C to 25°C		±5		mV
Total Output Error <sup>(7)</sup>	E <sub>TOT</sub>	I <sub>P</sub> =20A, T <sub>J</sub> =25°C to 125°C	-2.5		2.5	%
		I <sub>P</sub> =20A, T <sub>J</sub> =-40°C to 25°C		±1.5		%
Sensitivity Error Lifetime Drift <sup>(9)</sup>	E <sub>Sens(D)</sub>			±1		%
Total Output Error Lifetime Drift <sup>(9)</sup>	E <sub>TOT(D)</sub>			±1		%

**MCS1803-30 PERFORMANCE CHARACTERISTICS <sup>(3)</sup>**
**VCC=5V, C<sub>F</sub>=0nF, C<sub>L</sub>=1nF, T<sub>J</sub>=-40°C to +125°C, unless otherwise noted.**

Parameters	Symbol	Condition	Min	Typ <sup>(10)</sup>	Max	Units
Optimized Accuracy Range <sup>(5)</sup>	I <sub>P</sub>		-30		30	A
Sensitivity	Sens	-30A ≤ I <sub>P</sub> ≤ 30A, T <sub>J</sub> =25°C		66		mV/A
Sensitivity Error	E <sub>Sens</sub>	I <sub>P</sub> =30A, T <sub>J</sub> =25°C to 125°C	-2		2	%
		I <sub>P</sub> =30A, T <sub>J</sub> =-40°C to 25°C		±1.5		%
Offset Voltage <sup>(6)</sup>	V <sub>OE</sub>	I <sub>P</sub> =0A, T <sub>J</sub> =25°C to 125°C	-10		10	mV
		I <sub>P</sub> =0A, T <sub>J</sub> =-40°C to 25°C		±5		mV
Total Output Error <sup>(7)</sup>	E <sub>TOT</sub>	I <sub>P</sub> =30A, T <sub>J</sub> =25°C to 125°C	-2.5		2.5	%
		I <sub>P</sub> =30A, T <sub>J</sub> =-40°C to 25°C		±1.5		%
Sensitivity Error Lifetime Drift <sup>(9)</sup>	E <sub>Sens(D)</sub>			±1		%
Total Output Error Lifetime Drift <sup>(9)</sup>	E <sub>TOT(D)</sub>			±1		%

**MCS1803-40 PERFORMANCE CHARACTERISTICS <sup>(3)</sup>**
**VCC=5V, C<sub>F</sub>=0nF, C<sub>L</sub>=1nF, T<sub>J</sub>=-40°C to +125°C, unless otherwise noted.**

Parameters	Symbol	Condition	Min	Typ <sup>(10)</sup>	Max	Units
Optimized Accuracy Range <sup>(5)</sup>	I <sub>P</sub>		-40		40	A
Sensitivity	Sens	-40A ≤ I <sub>P</sub> ≤ 40A, T <sub>J</sub> =25°C		50		mV/A
Sensitivity Error	E <sub>Sens</sub>	I <sub>P</sub> =40A, T <sub>J</sub> =25°C to 125°C	-2		2	%
		I <sub>P</sub> =40A, T <sub>J</sub> =-40°C to 25°C		±1.5		%
Offset Voltage <sup>(6)</sup>	V <sub>OE</sub>	I <sub>P</sub> =0A, T <sub>J</sub> =25°C to 125°C	-10		10	mV
		I <sub>P</sub> =0A, T <sub>J</sub> =-40°C to 25°C		±5		mV
Total Output Error <sup>(7)</sup>	E <sub>TOT</sub>	I <sub>P</sub> =40A, T <sub>J</sub> =25°C to 125°C	-2.5		2.5	%
		I <sub>P</sub> =40A, T <sub>J</sub> =-40°C to 25°C		±1.5		%
Sensitivity Error Lifetime Drift <sup>(9)</sup>	E <sub>Sens(D)</sub>			±1		%
Total Output Error Lifetime Drift <sup>(9)</sup>	E <sub>TOT(D)</sub>			±1		%

**MCS1803-50 PERFORMANCE CHARACTERISTICS <sup>(3)</sup>**
**VCC=5V, C<sub>F</sub>=0nF, C<sub>L</sub>=1nF, T<sub>J</sub>=-40°C to +125°C, unless otherwise noted.**

Parameters	Symbol	Condition	Min	Typ <sup>(10)</sup>	Max	Units
Optimized Accuracy Range <sup>(5)</sup>	I <sub>P</sub>		-50		50	A
Sensitivity	Sens	-50A ≤ I <sub>P</sub> ≤ 50A, T <sub>J</sub> =25°C		40		mV/A
Sensitivity Error	E <sub>Sens</sub>	I <sub>P</sub> =50A, T <sub>J</sub> =25°C to 125°C	-2		2	%
		I <sub>P</sub> =50A, T <sub>J</sub> =-40°C to 25°C		±1.5		%
Offset Voltage <sup>(6)</sup>	V <sub>OE</sub>	I <sub>P</sub> =0A, T <sub>J</sub> =25°C to 125°C	10		10	mV
		I <sub>P</sub> =0A, T <sub>J</sub> =-40°C to 25°C		±5		mV
Total Output Error <sup>(7)</sup>	E <sub>TOT</sub>	I <sub>P</sub> =50A, T <sub>J</sub> =25°C to 125°C	-2.5		2.5	%
		I <sub>P</sub> =50A, T <sub>J</sub> =-40°C to 25°C		±1.5		%
Sensitivity Error Lifetime Drift <sup>(9)</sup>	E <sub>Sens(D)</sub>			±1		%
Total Output Error Lifetime Drift <sup>(9)</sup>	E <sub>TOT(D)</sub>			±1		%

**Notes:**

- (3) See below for the definitions of characteristics.
- (4) The IC continues to respond to current beyond the range of I<sub>P</sub> until the high or low saturation voltage; however, the nonlinearity in the region I<sub>P</sub> beyond is worse than through the rest of the measurement range.
- (5) Device may be operated at higher primary current levels I<sub>P</sub> and ambient temperatures T<sub>A</sub>, provided that the Maximum Junction Temperature T<sub>J</sub>(MAX) is not exceeded.
- (6) Offset Voltage does not incorporate any error due to external magnetic fields.
- (7) Percentage of I<sub>P</sub>, with I<sub>P</sub> = I<sub>P,MAX</sub>. Output filtered.
- (8) Guaranteed by design.
- (9) Guaranteed by characterization.
- (10) Typical values with "±" are ±3 sigma values.
- (11) The resistance is defined as the total resistance measured from a point of the lead just next to the solder joint (see figure below), and assuming that the two IP+ pins (and IP- pins) have the same potential. This definition corresponds to the effective resistance used to estimate the Joule heating with  $R I_P^2$ .

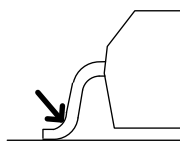

## TYPICAL CHARACTERISTICS

MCS1803GS-50 for reference

Offset Voltage vs. Temperature

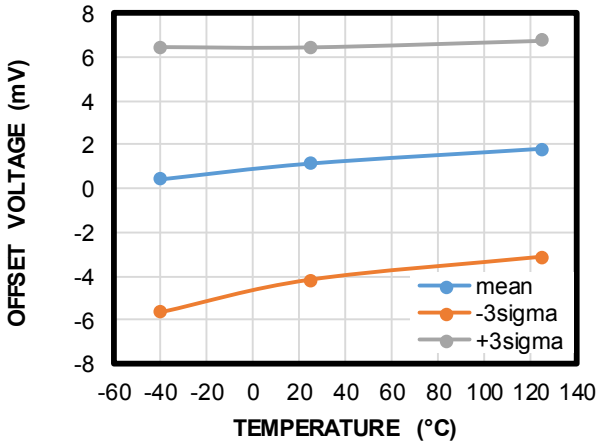

Sensitivity vs. Temperature

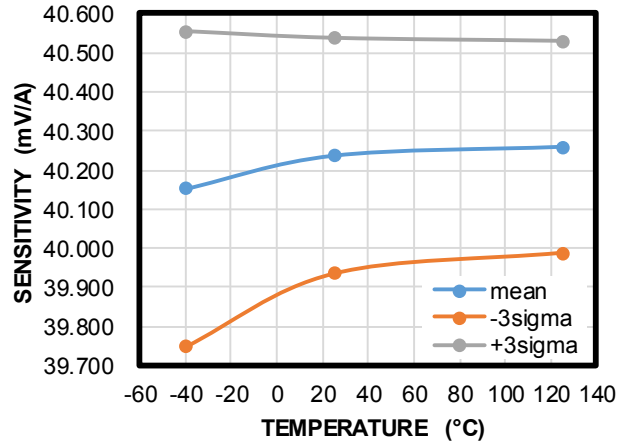

Sensitivity Error vs. Temperature

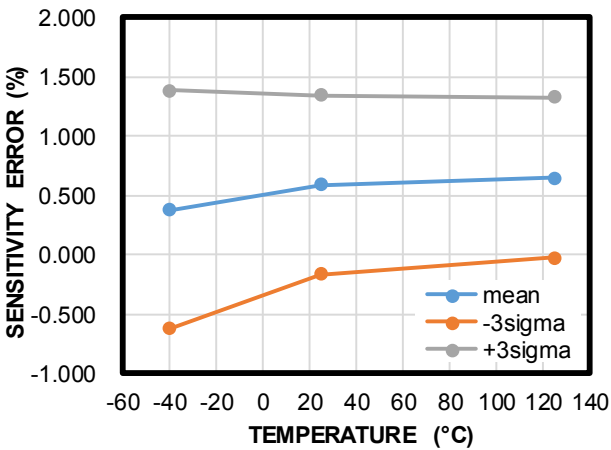

Total Error vs. Temperature

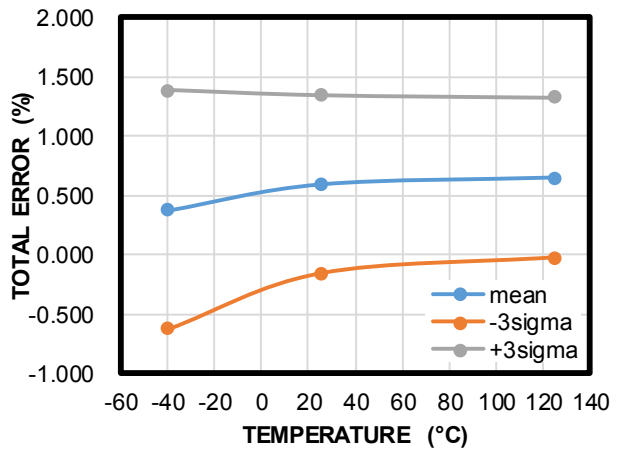

**BLOCK DIAGRAM**

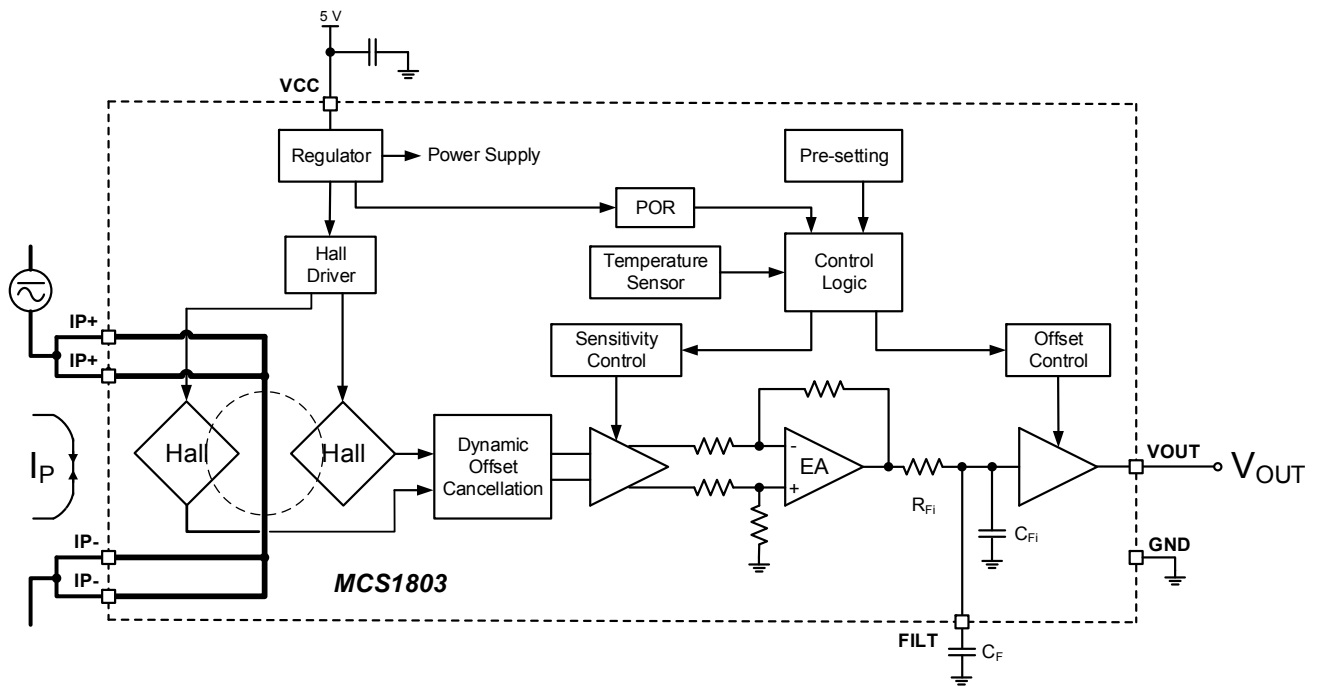
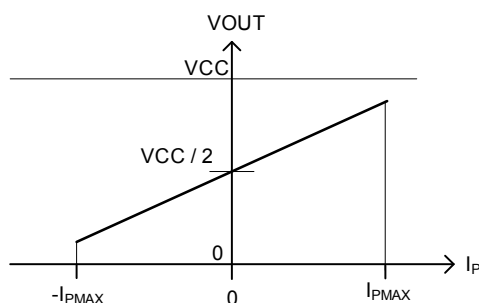

**Figure 1: Functional Block Diagram**

## DEFINITIONS

### Current rating

$I_{P_{MAX}}$  is the rated current. The sensor output is linear as a function of the primary current  $I_P$  and follows the specified performances when  $I_P$  is between  $-I_{P_{MAX}}$  and  $+I_{P_{MAX}}$ .



**Figure 2 : sensor output function**

### Sensitivity (Sens)

The Sensitivity in mV/A indicates how much the output changes when the primary current changes. It is the product of the average between the 2 coupling constants  $P_{MCF1}$  and  $P_{MCF2}$  (in mT/A) and the transducer gain (in mV/mT). The gain is factory trimmed to the sensor target sensitivity.

### Coupling constants ( $P_{MCF1}$ and $P_{MCF2}$ )

The first and second Hall magnetic coupling factor are defined as the amount of vertical magnetic field (see the arrows  $B_1$  and  $B_2$ ) produced at the sensing points 1 and 2, per unit of current injected in the primary conductor. Due to the non-symmetric shape of the primary conductor the magnetic field generated in the two sensing points are different.

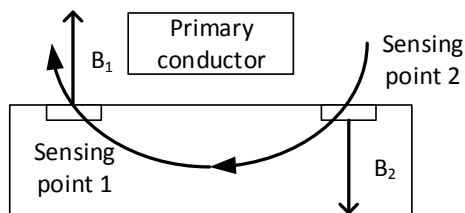

**Figure 3: Schematic cross section of the sensor**

### Noise ( $V_{NOISE}$ )

The noise is a random deviation and cannot be calibrated out. The input referred noise is the root mean square sensor output noise in mV, divided by the sensitivity in mV/A. It represents the smallest current that the device is able to

resolve, without any external signal treatment (it is generally accepted that the resolution is 3 times the rms noise).

Other deviations are systematic, meaning that they represent the average deviation over a large number of data points. They can be calibrated out.

### Zero Current Output Voltage ( $V_{OUT(Q)}$ )

$V_{OUT(Q)}$  is the voltage output when the primary current is zero. The nominal value is  $VCC/2$ . Variation in  $V_{OUT(Q)}$  from the nominal value is due to thermal drift and the resolution limits of voltage offset trimming in the factory.

### Offset Voltage ( $V_{OE}$ )

The difference between  $VCC/2$  and the zero current output. To convert this voltage into amperes, divide by the sensitivity.

### Nonlinearity ( $E_{LIN}$ )

Ideally the primary current vs sensor output function is a straight line. The non-linearity is an indication of the worst deviation from this straight line.

The nonlinearity in % is defined by:

$$E_{LIN} = \frac{\max(V_{out}(I_P) - V_{lin}(I_P))}{V_{out}(I_{P_{MAX}}) - V_{out}(-I_{P_{MAX}})} \times 100$$

where  $V_{lin}(I_P)$  is the approximate straight line calculated by the least square method. Note: depending on the curvature of  $V_{out}(I_P)$ ,  $E_{LIN}$  can be negative or positive.

### Total Output Error ( $E_{TOT}$ )

$E_{TOT}$  in % is the relative difference between the sensor output and the ideal output at a given primary current  $I_P$ :

$$E_{TOT}(I_P) = \frac{V_{out}(I_P) - V_{out\ ideal}(I_P)}{Sens \cdot I_P} \times 100$$

where,

$$V_{out\ ideal}(I_P) = \frac{VCC}{2} + Sens \cdot I_P$$

The Total Output Error incorporates all sources of error and is a function of  $I_P$ . At current close to  $I_{P_{MAX}}$  the  $E_{TOT}$  error is affected mainly by

sensitivity error. At current close to zero, the  $E_{TOT}$  error is mostly due to the Offset Voltage ( $V_{OE}$ ). Note that when  $I_P = 0$ ,  $E_{TOT}$  diverges to infinity because of constant offset.

### Ratiometry coefficients

Ideally the sensor output is ratiometric, it means that the sensitivity and the zero current output scales with  $V_{DD}$ . The ratiometry coefficients measures how good is this proportionality.

$$K_{SENS} = \frac{Sens(V_{CC}) / Sens(5V)}{V_{CC} / 5V}$$

$$K_{VO} = \frac{V_{OUT}(I_P = 0, V_{CC}) / V_{OUT}(I_P = 0, 5V)}{V_{CC} / 5V}$$

Ideally both  $K_{SENS}$  and  $K_{VO}$  are 1.

### Power-On Time ( $t_{PO}$ )

This reflects the time interval after power is first applied to the device until the output can be considered to correctly indicate the applied primary current. The Power-On Time ( $t_{PO}$ ) is defined as the time taken between the supply reaching the minimum operating voltage  $V_{CC_{MIN}}$  ( $t_1$ ), and the output voltage to settling to within  $\pm 10\%$  of its steady state value under an applied primary current ( $t_2$ ) (See Figure 4).

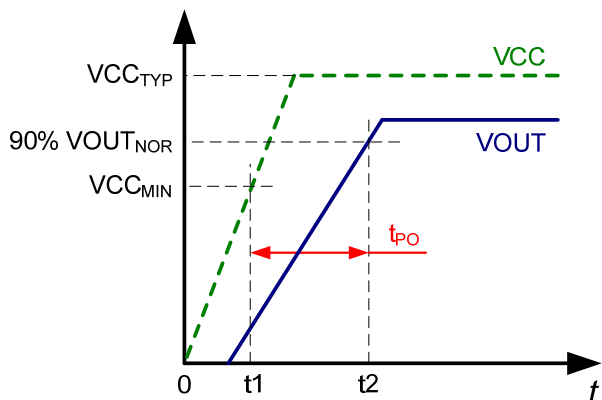

**Figure 4: Power-On Time ( $t_{PO}$ )**

### Propagation Delay ( $t_{pd}$ )

The propagation delay represents the internal latency between an event to be measured and the sensor response. It is measured as a time interval between the primary current signal reaching 20% of  $I_{P\_MAX}$  ( $t_1$ ) and the time for the voltage to reach 20% of  $V_{OUT\_MAX}$  ( $t_2$ ). See Figure 5.

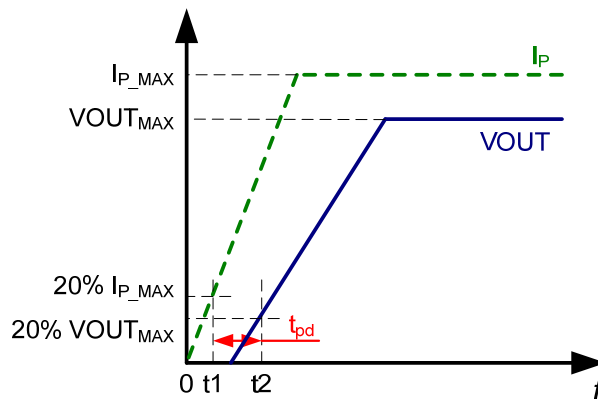
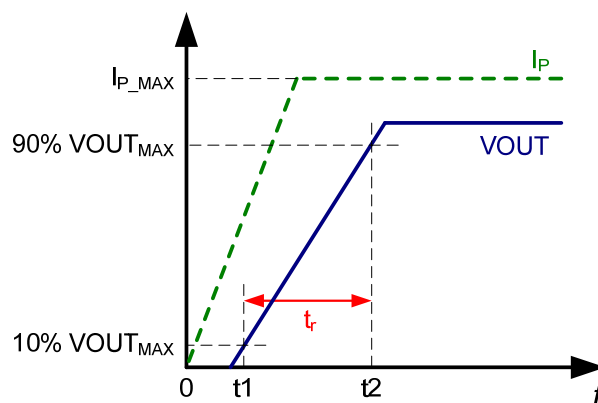

**Figure 5: Propagation Delay ( $t_{pd}$ )**

### Rise Time ( $t_r$ )

Rise Time is the time interval between the sensor  $V_{OUT}$  reaching 10% of its full scale value ( $t_1$ ), and it reaching 90% of its full scale value ( $t_2$ ). See Figure 6. The sensor bandwidth, defined as the 3dB cutoff frequency, can be derived by the rise time of the response to an applied step by the relation:

$$f_{BW} = 0.35 / t_r$$



**Figure 6: Rise Time ( $t_r$ )**

### Response Time ( $t_{RESPONSE}$ )

$t_{RESPONSE}$  is a combination of the previously defined times: it is the time interval between the primary current signal reaching 90% of its final value ( $t_1$ ), and the device  $V_{OUT}$  reaching 90% of its output corresponding to the applied primary current ( $t_2$ ). (See Figure 7)

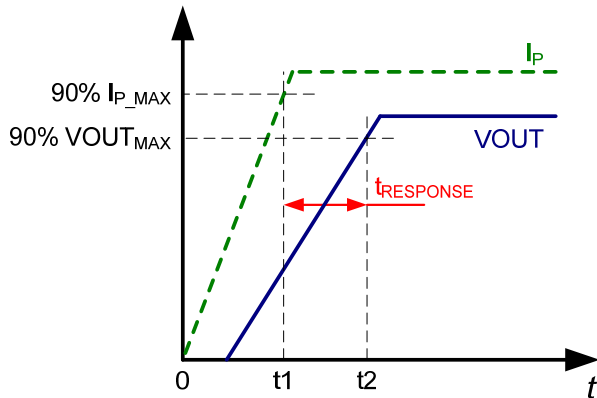

Figure 7: Response Time ( $t_{\text{RESPONSE}}$ )

Cut way ground/power planes under the IC to reduce the effect of eddy currents on  $t_r$  and  $t_{\text{RESPONSE}}$ .

### Adjustable Bandwidth

The sensor dynamic can be adjusted by connecting the external capacitor  $C_F$ . The bandwidth can then be calculated with:

$$f_{BW} = \frac{1}{2\pi R_{Fi}} \frac{1}{(C_{Fi} + C_F)}$$

The typical bandwidth curve is shown as Figure 8.

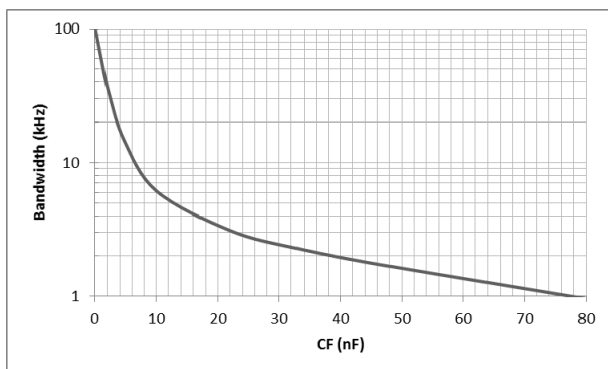

Figure 8: Bandwidth vs.  $C_F$

## APPLICATION INFORMATION

### Self-heating Performance

Current flowing through the primary conductor can raise the conductor and the sensor IC temperature. Therefore self-heating should be carefully verified to ensure the IC junction does not exceed the maximum (see the absolute maximum rating table).

The thermal behavior strongly depends on thermal environment of the MCS components and its cooling capacity, in particular the PCB copper area and thickness. The thermal response also depends on the profile of the current waveform which means on the amplitude and frequency for an AC current, and on the peaks and duty cycle for a pulsed DC current.

The plot in Figure 9 shows the self-heating performance with DC current input. The data is collected with the part mounted on the MCS180X demo board at 25°C T<sub>A</sub> after 10 minutes of continuous current.

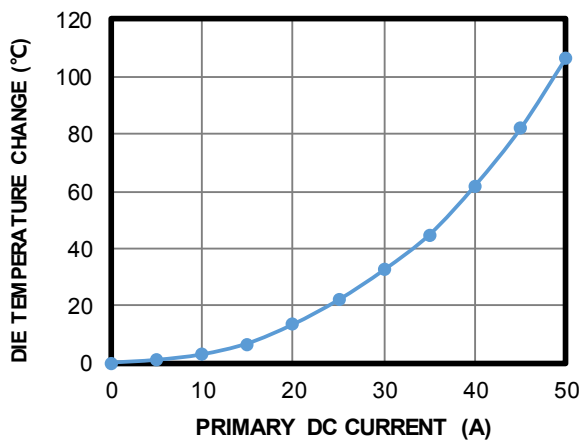

**Figure 9: Self-heating Performance with DC Current Input**

Figure 10 shows the top and bottom layers of the MCS180X demo board, the board includes in total 2200 mm<sup>2</sup>, 4 oz (139 μm) copper connected to the primary conductor by the IP+ and IP- pins. The copper covers both the top and bottom side with thermal vias connecting the two layers.

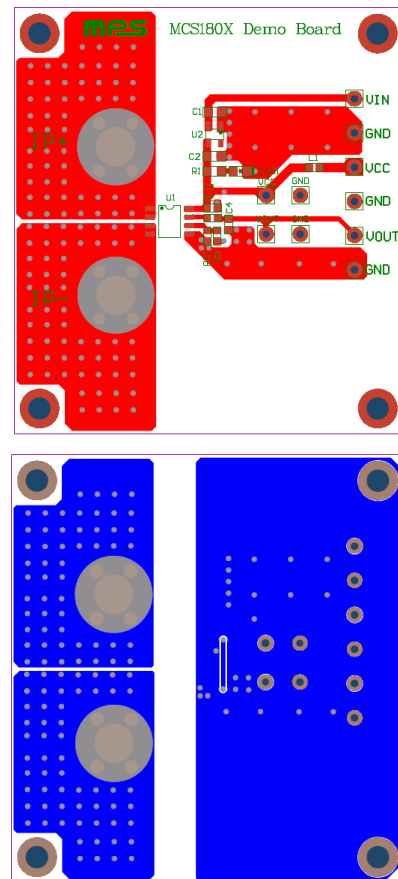

**Figure 10: Top and Bottom Layers of MCS180X Demo Board**



**TYPICAL APPLICATION CIRCUITS**

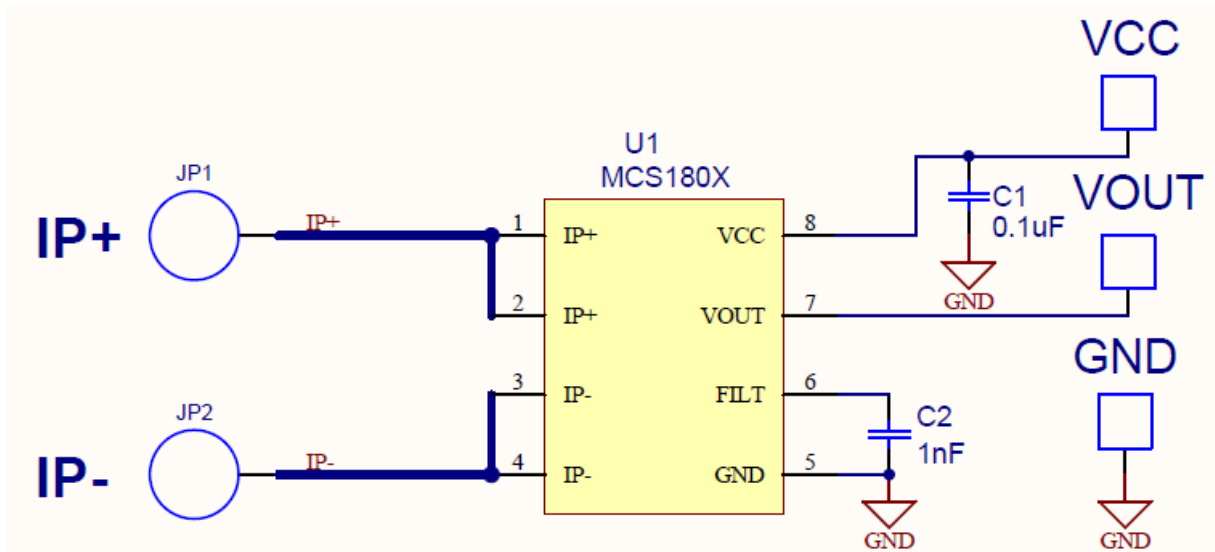

**Figure 11: Application Circuit**

**PACKAGE INFORMATION**

**SOIC-8**

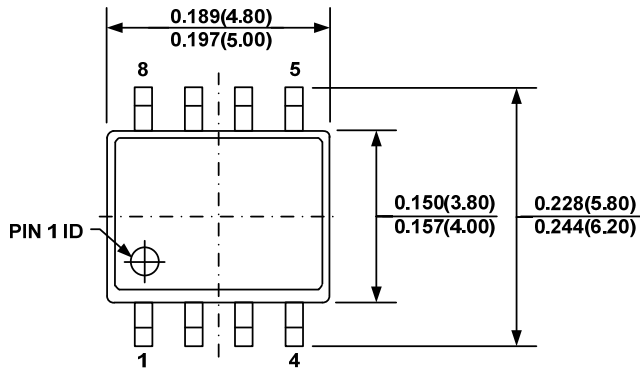

**TOP VIEW**

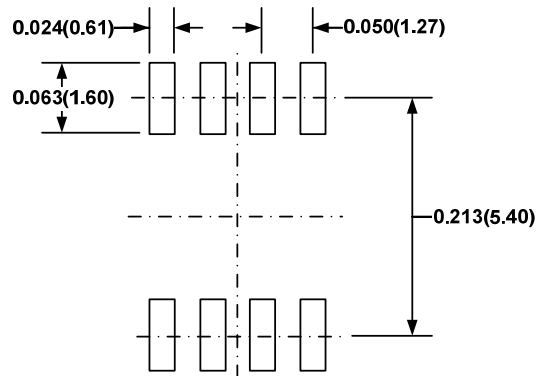

**RECOMMENDED LAND PATTERN**

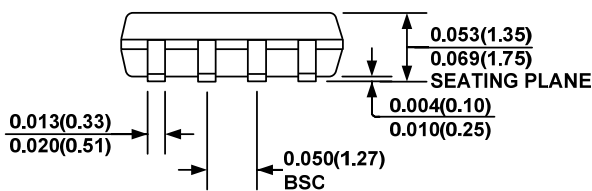

**FRONT VIEW**

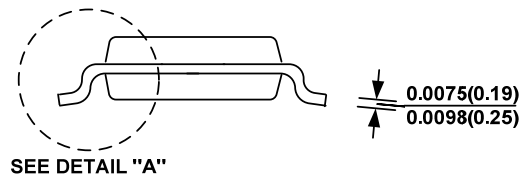

**SIDE VIEW**

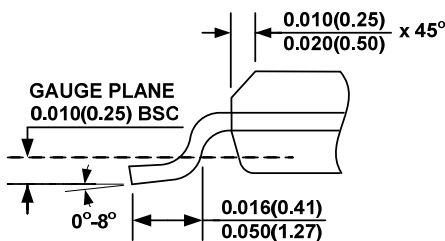

**DETAIL "A"**

**NOTE:**

- 1) CONTROL DIMENSION IS IN INCHES. DIMENSION IN BRACKET IS IN MILLIMETERS.
- 2) PACKAGE LENGTH DOES NOT INCLUDE MOLD FLASH, PROTRUSIONS OR GATE BURRS.
- 3) PACKAGE WIDTH DOES NOT INCLUDE INTERLEAD FLASH OR PROTRUSIONS.
- 4) LEAD COPLANARITY (BOTTOM OF LEADS AFTER FORMING) SHALL BE 0.004" INCHES MAX.
- 5) DRAWING CONFORMS TO JEDEC MS-012, VARIATION AA.
- 6) DRAWING IS NOT TO SCALE.

**NOTICE:** The information in this document is subject to change without notice. Please contact MPS for current specifications. Users should warrant and guarantee that third party Intellectual Property rights are not infringed upon when integrating MPS products into any application. MPS will not assume any legal responsibility for any said applications.