



EVQ8875A-VE-00A

36V, 5A, Single-Channel, Quad-Switch, Synchronous, DC/DC Buck-Boost Converter Evaluation Board

DESCRIPTION

The EVQ8875A-VE-00A is an evaluation board designed to demonstrate the capabilities of the MPQ8875A, a 36V, monolithic, synchronous DC/DC buck-boost converter.

The device's wide 2.2V to 36V input voltage range is ideal for multi-purpose automotive and industrial applications.

Constant-on-time (COT) control and the integrated quad-switch configuration allow the MPQ8875A to flexibly change between the buck, boost, and buck-boost topologies. This optimizes performance and efficiency for input voltages above, below, or equal to the output voltage (V_{OUT}). COT also ensures seamless transitions between the adjacent operational regions.

The MPQ8875A's configurable parameters are set via the I²C interface, and do not require any additional hardware changes.

The switching frequency (f_{sw}) can be configured between 200kHz and 1MHz or synchronized between 250kHz and 1MHz via an external clock signal. To improve EMI performance, the configurable frequency spread spectrum function can dither f_{sw} periodically.

Fault protections include input under-voltage lockout (UVLO), input over-voltage protection (OVP), cycle-by-cycle peak current limiting, output OVP, output short-circuit protection (SCP), and thermal shutdown. The built-in power good (PG) indicator determines whether V_{OUT} is regulated properly.

The EVQ8875A-VE-00A is a fully assembled and tested evaluation board.

ELECTRICAL SPECIFICATIONS

Parameter	Symbol	Value	Units
Input voltage	V_{IN}	4.5 to 36	V
Output voltage	V_{OUT}	11.5	V
Output current	I_{OUT}	0 to 5	A

FEATURES

- Wide 2.2V to 36V Operating Input Range
- Up to 5A Continuous Output Current
- <25 μ A Shutdown Current
- 180 μ A Quiescent Current when $V_{IN} = 12V$
- Single-Channel, Quad-Switch, Synchronous Buck-Boost Configuration:
 - 10m Ω Internal Buck HS-FET
 - 10m Ω Internal Boost LS-FET
 - 25m Ω Internal Boost High-Side (HS) Synchronous Rectifier
 - 25m Ω Internal Buck Low-Side (LS) Synchronous Rectifier
- COT Control for Seamless Transitions
- Internal Soft Start (SS)
- Smart Power Good (PG) Output
- Optimized for Efficiency and EMI Performance:
 - 200kHz to 1MHz Configurable Switching Frequency (f_{sw})
 - 250kHz to 1MHz Synchronized f_{sw}
 - Frequency Spread Spectrum
 - Configurable Switching Speed
- Protection Features:
 - Cycle-by-Cycle Current Limiting
 - Over-Current Protection (OCP)
 - Configurable Input UVLO
 - Output Over-Voltage Protection (OVP)
 - Input OVP
 - Output Short-Circuit Protection (SCP)
 - Over-Temperature Protection (OTP)
- Standard, Configurable via I²C Interface:
 - Converter On/Off
 - Input Range Selection
 - 0.5V to 30V Output Range for Forced Continuous Conduction Mode (FCCM)
 - 5V to 30V Output Range for Discontinuous Conduction Mode (DCM)
 - Synchronized Input and Output
 - Switching Slew Rate
 - f_{sw}
 - Frequency Spread Spectrum
 - Compensation Network
 - Ramp Compensation

FEATURES (continued)

- Soft-Start Time
- Dynamic V_{OUT} with Slew Rate Control
- DCM and FCCM
- COT Control for Boost Switch in Buck-Boost Mode
- Input and Output OVP
- Cycle-by-Cycle Current Limit Threshold
- Reverse Current Limit Threshold
- OCP
- Output SCP
- Thermal Protection
- PG Threshold
- Junction Temperature Reading
- One-Time Programmable (OTP) Default Parameter
- Available in a QFN-34 (4mmx5mm) Package
- Available in a Wettable Flank Package
- Available in AEC-Q100 Grade 1

APPLICATIONS

- Sensor Fusion Systems
- Camera Monitoring Systems
- Infotainment Systems
- Automotive Applications

All MPS parts are lead-free, halogen-free, and adhere to the RoHS directive. For MPS green status, please visit the MPS website under Quality Assurance. "MPS", the MPS logo, and "Simple, Easy Solutions" are trademarks of Monolithic Power Systems, Inc. or its subsidiaries.

EVQ8875A-VE-00A EVALUATION BOARD

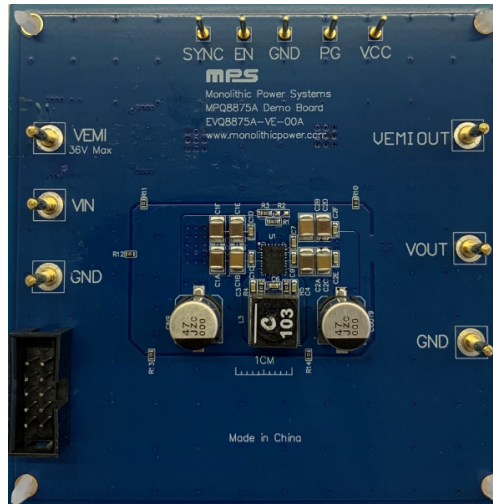

LxWxH (9cmx9cmx1.3cm)

Board Number	MPS IC Number
EVQ8875A-VE-00A	MPQ8875A

Efficiency vs. Load Current

$V_{OUT} = 11.5V$, $f_{sw} = 450kHz$, FCCM,
 $L = 10\mu H$ (23m Ω DCR), $I_{OUT} = 10mA$ to 1A

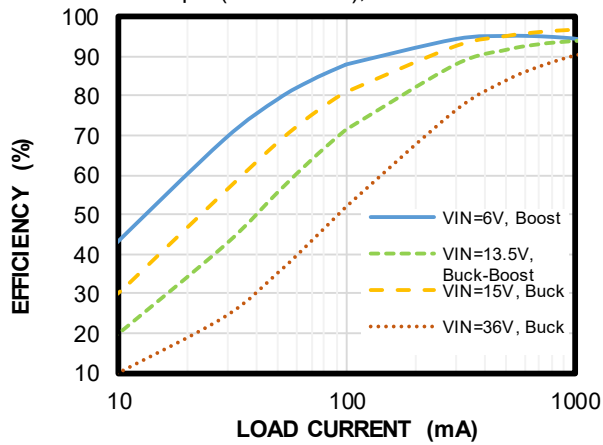

Efficiency vs. Load Current

$V_{OUT} = 11.5V$, $f_{sw} = 450kHz$, FCCM,
 $L = 10\mu H$ (23m Ω DCR), $I_{OUT} = 0.5A$ to 5A

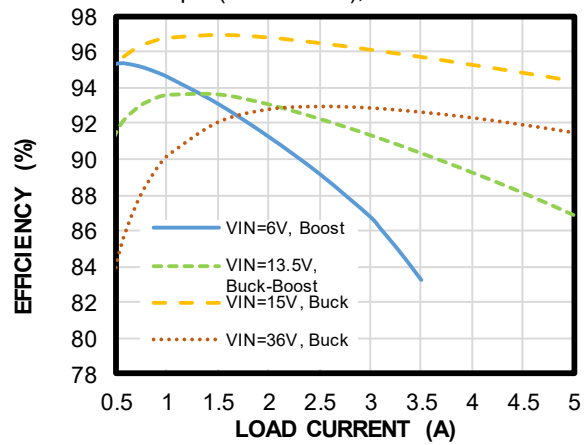

QUICK START GUIDE

1. Preset the load current between 0A and 5A, and preset the power supply between 4.5V and 36V. Note that electronic loads represent a negative impedance to the regulator, which can trigger over-current protection (OCP) if the current is set too high.
2. Turn off the power supply. If longer cables (>0.5m total) are being used between the source and the evaluation board, install a damping capacitor at the input terminals. This is critical when V_{IN} exceeds 24V.
3. Connect the power supply terminals to:
 - a. Positive (+): VIN
 - b. Negative (-): GND
4. For EMI testing, connect the power supply terminals to:
 - a. Positive (+): VEMI
 - b. Negative (-): GND
5. Connect the load terminals to:
 - a. Positive (+): VOUT
 - b. Negative (-): GND
6. For EMI testing, connect the load terminals to:
 - a. Positive (+): VEMI_OUT
 - b. Negative (-): GND
7. After making the connections, turn on the power supply. The MPQ8875A should automatically start up. The default V_{OUT} is 11.5V.
8. To use the enable (EN) function, apply a digital input to the EN pin. Drive EN between 1.55V to 5.5V to turn the regulator on; drive EN below 1.4V to turn it off. ⁽¹⁾

Note:

- 1) For more information and function tests, refer to the MPQ8875A GUI, which can be downloaded from the MPS website.

EVALUATION BOARD SCHEMATIC

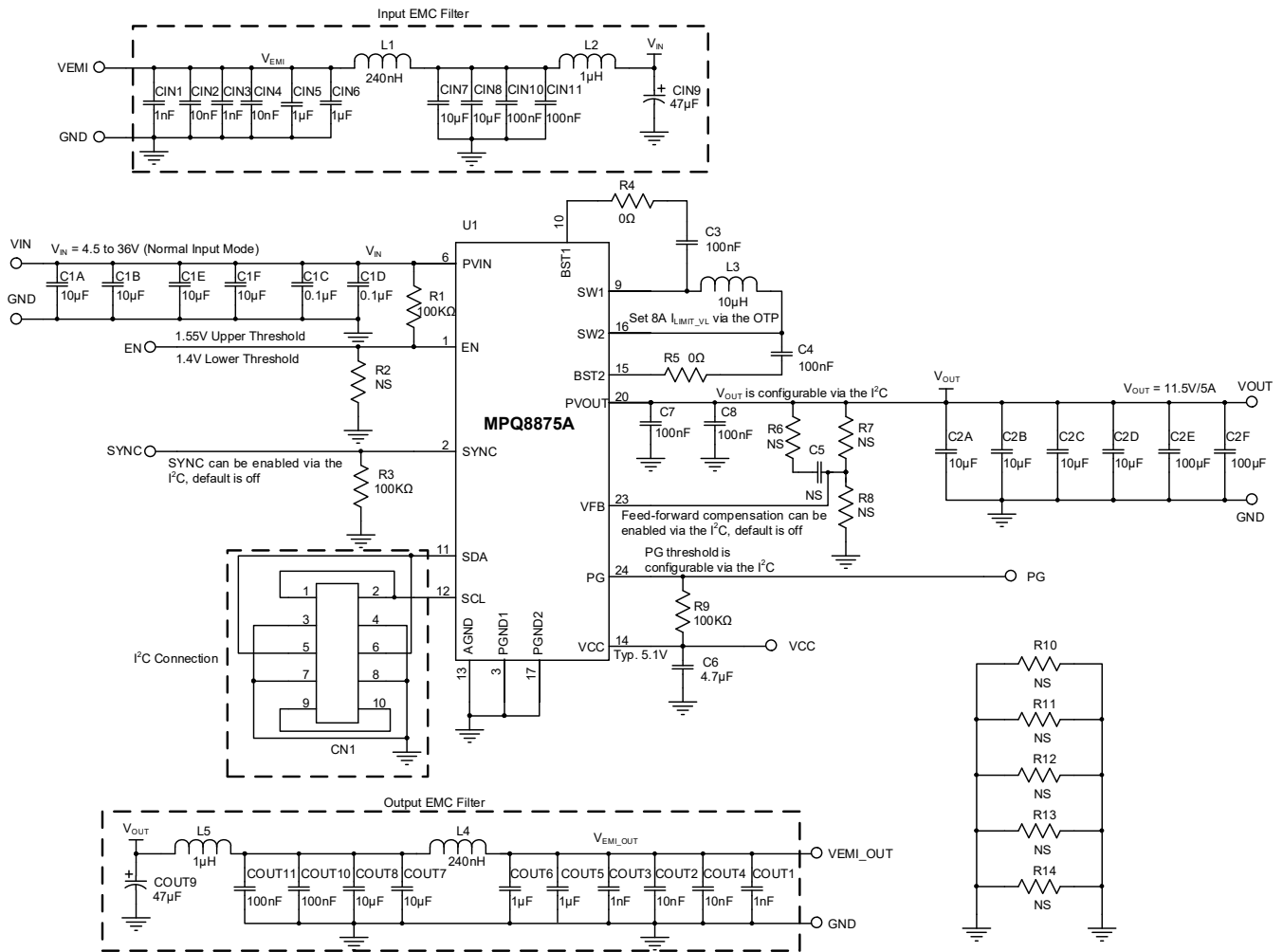

Figure 1: Evaluation Board Schematic

EVQ8875A-VE-00A BILL OF MATERIALS

Qty	Ref	Value	Description	Package	Manufacturer	Manufacturer PN
4	CIN1, CIN3, COUT1, COUT3	1nF	Ceramic capacitor, 50V, X7R	0603	Murata	GRM188R71H102KA01D
4	CIN2, CIN4, COUT2, COUT4	10nF	Ceramic capacitor, 50V, X7R	0603	Murata	GRM188R71H103KA01D
4	CIN5, CIN6, COUT5, COUT6	1 μ F	Ceramic capacitor, 50V, X7R	0805	Murata	GRM21BR71H105KA12L
4	CIN7, CIN8, COUT7, COUT8	10 μ F	Ceramic capacitor, 50V, X5R	1206	Murata	GRM31CR61H106KA12L
2	CIN9, COUT9	47 μ F	63V, 40m Ω	SMD	Panasonic	EEHZC1J470P
12	CIN10, CIN11, COUT10, COUT11, C1C, C1D, C3, C4, C7, C8, C2E, C2F	0.1 μ F	Ceramic capacitor, 50V, X7R	0603	Murata	GRM188R71H104KA93D
8	C1A, C1B, C1E, C1F, C2A, C2B, 2C, C2D	10 μ F	Ceramic capacitor, 50V, X7R	1210	Murata	GRM32ER71H106KA12L
0	C5	NS		0603		
1	C6	4.7 μ F	Ceramic capacitor, 10V, X5R	0603	Murata	GRM188R61A475KE15D
2	L1, L4	240nH	Inductor, 19m Ω , 6.6A	SMD	Toko	DFE201612E-R24M=P2
2	L2, L5	1 μ H	Inductor, 14.6m Ω , 9.6A	SMD	Coilcraft	XEL4020-102MEB
1	L3	10 μ H	Inductor, 23.1m Ω , 8.7A	SMD	Coilcraft	XAL8080-103MEB
3	R1, R3, R9	100k Ω	Film resistor, 1%	0603	Yageo	RC0603FR-07100KL
0	R2, R6, R7, R8,	NS				
7	R4, R5, R10, R11, R12, R13, R14	0 Ω	Film resistor, 5%	0603	Yageo	RC0603JR-070RL
1	U1	MPQ8875A	Quad-switch buck- boost converter	QFN-34 (4mmx5mm)	MPS	MPQ8875AGRE-0000- AEC1
6	VEMI, VIN, GND, VEMI_OUT, VOUT, GND	2mm	Golden pins, test point	DIP	Any	
5	SYNC, VCC, EN, PG, GND	1mm	Golden pin, test point	DIP	Any	
1	CN1	2.54mm	Male box header, 2x5	DIP	Any	

EVB TEST RESULTS

$V_{IN} = 13.5V$, $V_{OUT} = 11.5V$, $L = 10\mu H$, $C_{OUT} = 40\mu F$, $f_{SW} = 450kHz$, FCCM, $T_A = 25^\circ C$, unless otherwise noted.

Efficiency vs. Load Current

$V_{OUT} = 11.5V$, FCCM, $I_{OUT} = 10mA$ to 1A

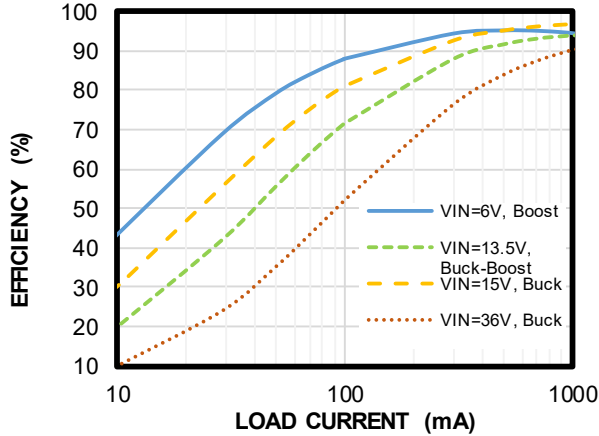

Efficiency vs. Load Current

$V_{OUT} = 11.5V$, FCCM, $I_{OUT} = 0.5A$ to 5A

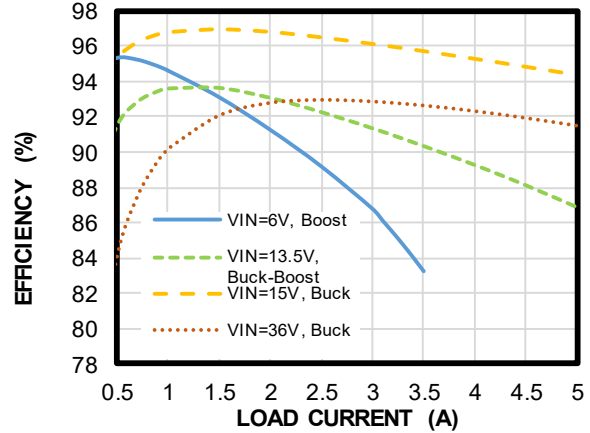

Efficiency vs. Load Current

$V_{OUT} = 11.5V$, DCM, $I_{OUT} = 10mA$ to 1A

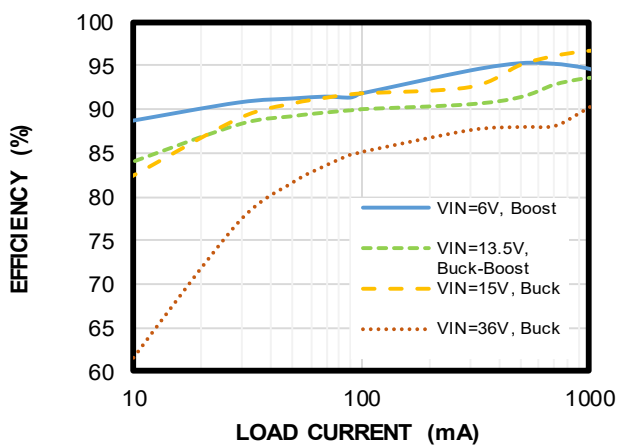

Efficiency vs. Load Current

$V_{OUT} = 11.5V$, DCM, $I_{OUT} = 0.5A$ to 5A

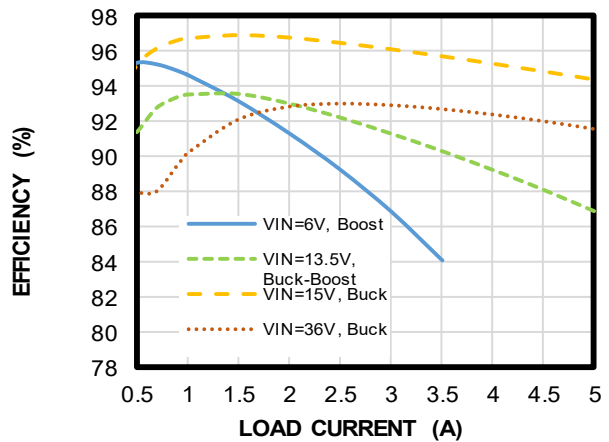

Efficiency vs. Load Current

$V_{OUT} = 9V$, FCCM, $I_{OUT} = 10mA$ to 1A

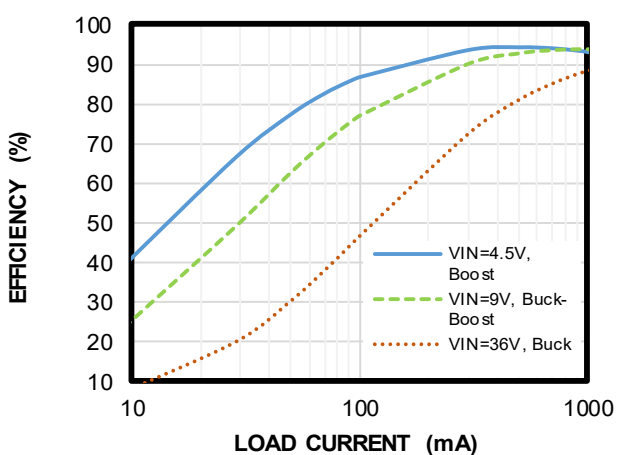

Efficiency vs. Load Current

$V_{OUT} = 9V$, FCCM, $I_{OUT} = 0.5A$ to 5A

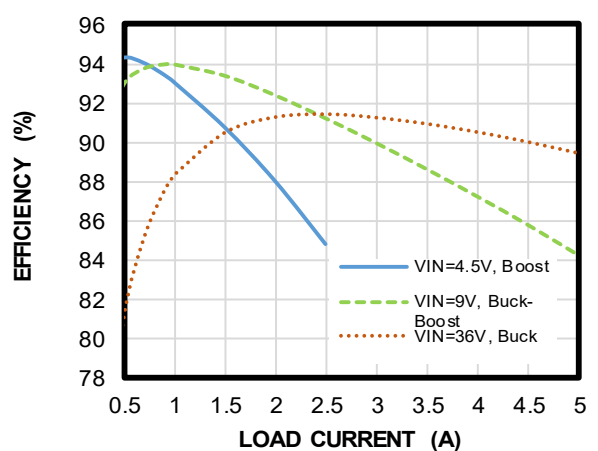

EVB TEST RESULTS (continued)

$V_{IN} = 13.5V$, $V_{OUT} = 11.5V$, $L = 10\mu H$, $C_{OUT} = 40\mu F$, $f_{SW} = 450kHz$, FCCM, $T_A = 25^\circ C$, unless otherwise noted.

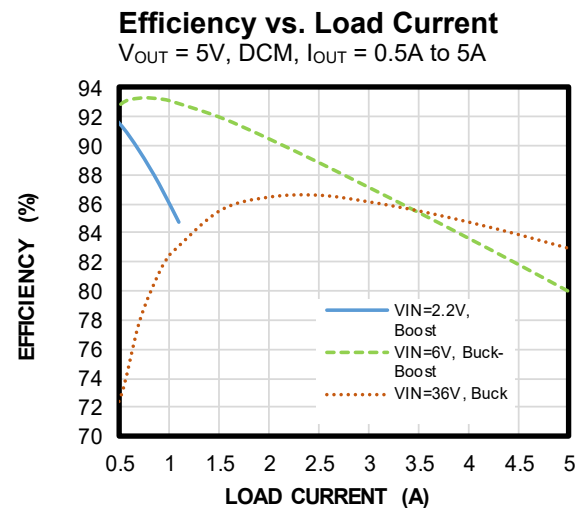
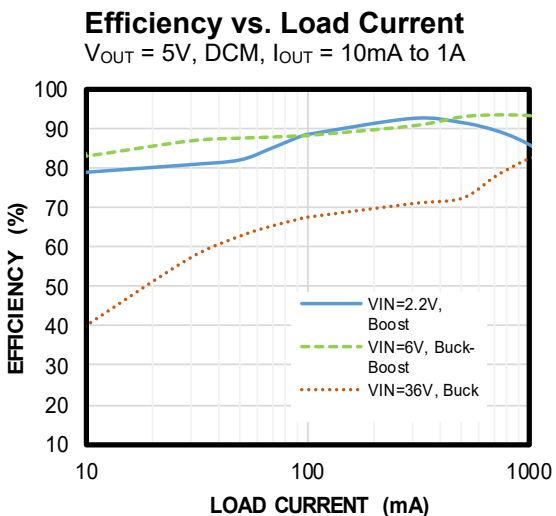
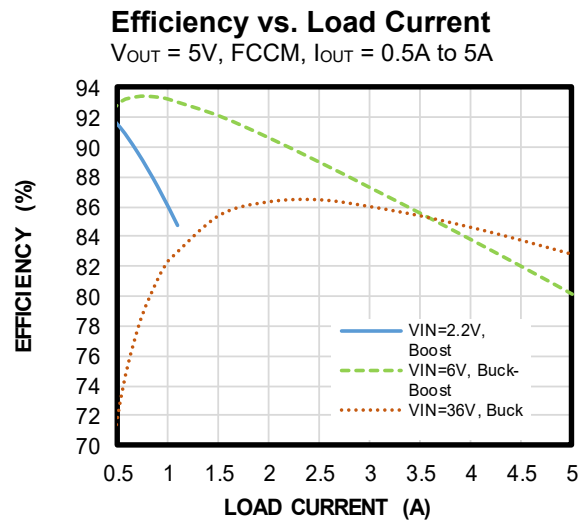
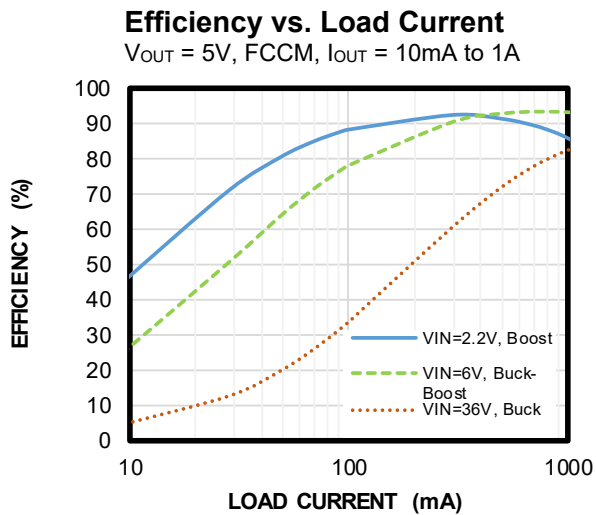
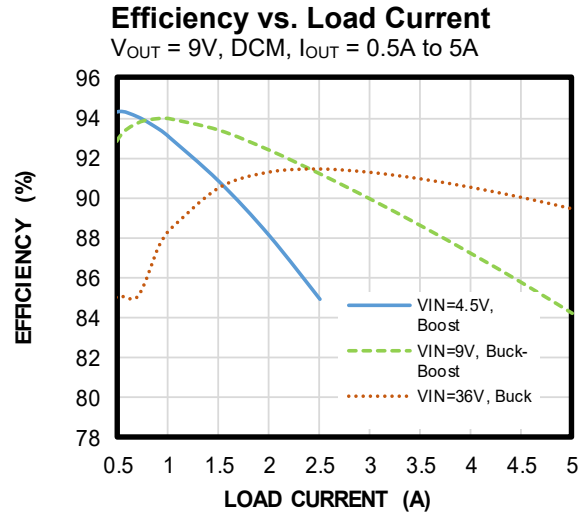
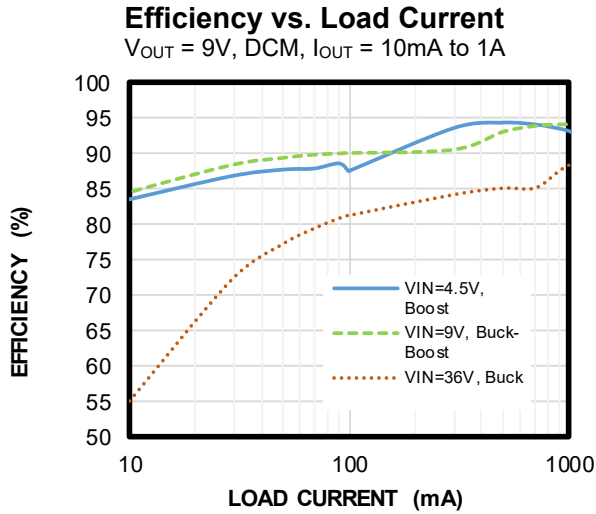

EVB TEST RESULTS (continued)

$V_{IN} = 13.5V$, $V_{OUT} = 11.5V$, $L = 10\mu H$, $C_{OUT} = 40\mu F$, $f_{SW} = 450kHz$, FCCM, $T_A = 25^\circ C$, unless otherwise noted.

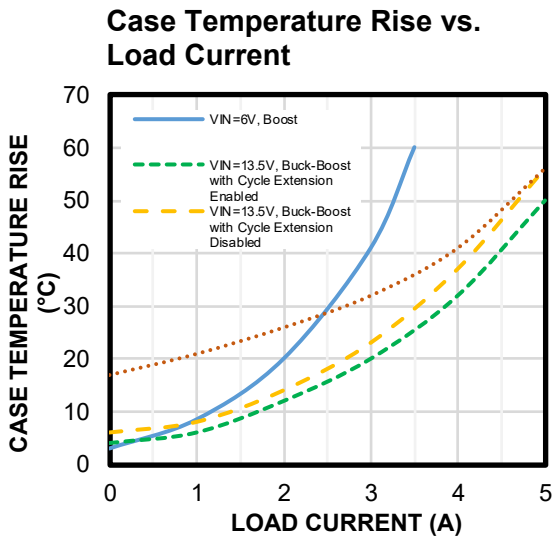
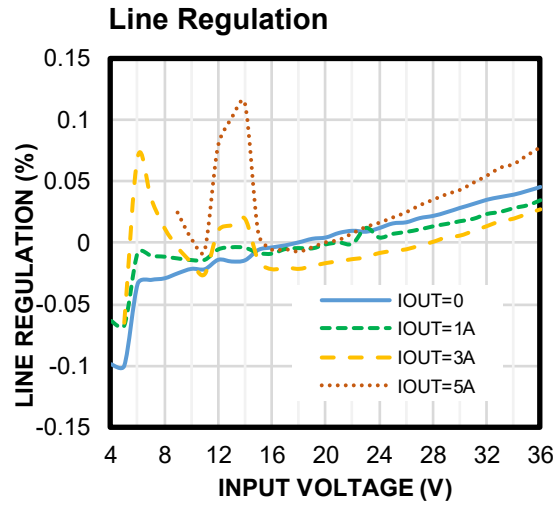
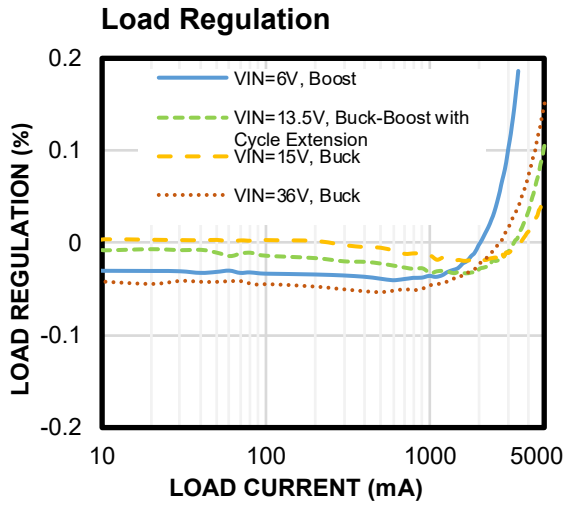

EVB TEST RESULTS (continued)

$V_{IN} = 13.5V$, $V_{OUT} = 11.5V$, $L = 10\mu H$, $C_{OUT} = 40\mu F$, $f_{SW} = 450kHz$, FCCM, $T_A = 25^\circ C$, unless otherwise noted.

Steady State

$V_{IN} = 6V$, $I_{OUT} = 0A$, boost mode

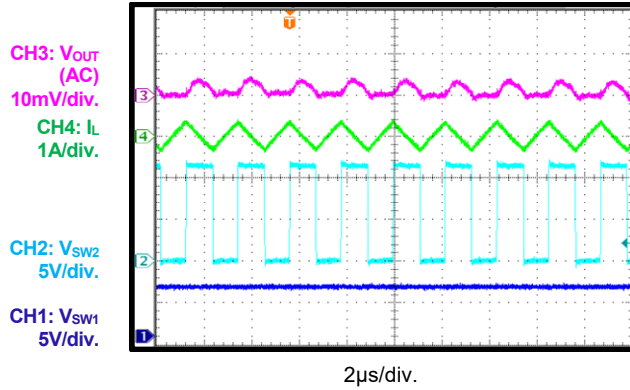

Steady State

$V_{IN} = 6V$, $I_{OUT} = 3.5A$, boost mode

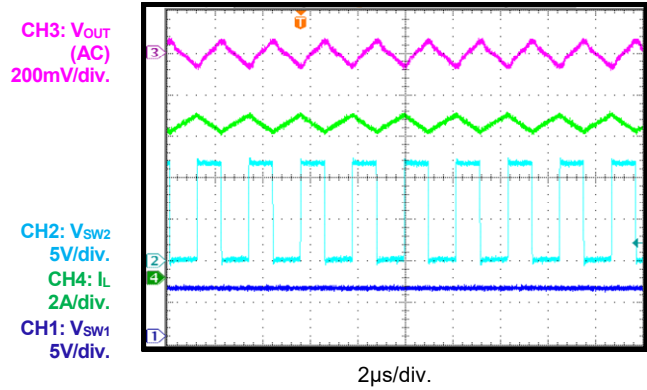

Steady State

$V_{IN} = 13.5V$, $I_{OUT} = 0A$, buck-boost mode

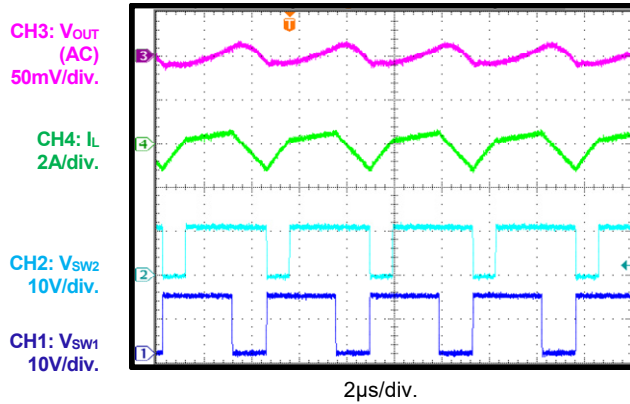

Steady State

$V_{IN} = 13.5V$, $I_{OUT} = 5A$, buck-boost mode

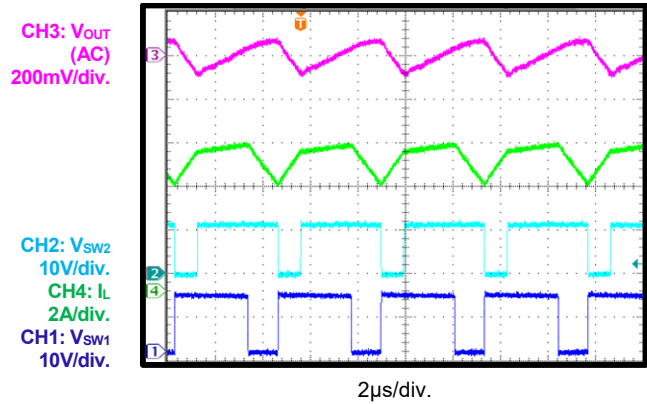

Steady State

$V_{IN} = 15V$, $I_{OUT} = 0A$, buck mode

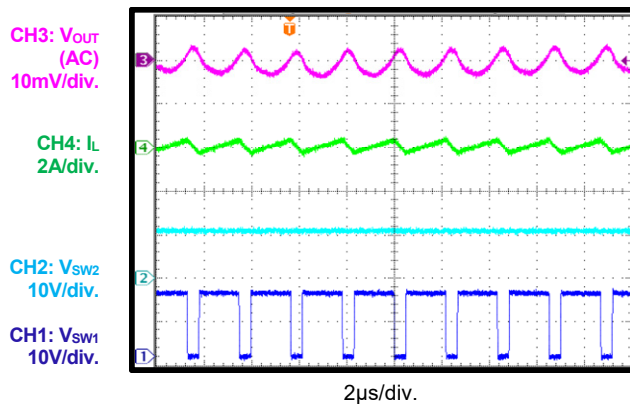

Steady State

$V_{IN} = 15V$, $I_{OUT} = 5A$, buck mode

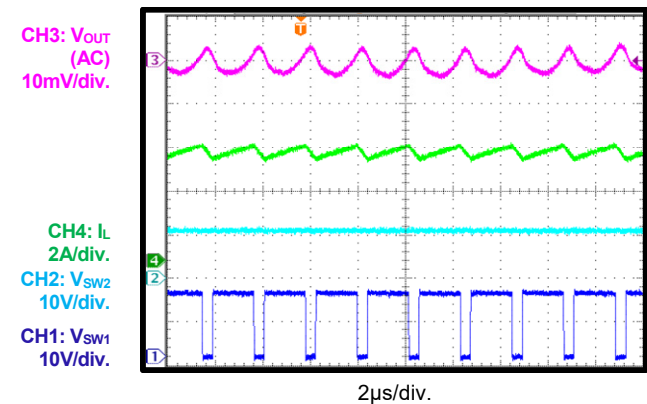

EVB TEST RESULTS (continued)

$V_{IN} = 13.5V$, $V_{OUT} = 11.5V$, $L = 10\mu H$, $C_{OUT} = 40\mu F$, $f_{SW} = 450kHz$, FCCM, $T_A = 25^\circ C$, unless otherwise noted.

Start-Up through VIN

$I_{OUT} = 0A$

CH3: V_{IN}
10V/div.
R1: V_{OUT}
5V/div.
CH4: I_L
2A/div.
CH2: V_{SW2}
10V/div.
CH1: V_{SW1}
10V/div.

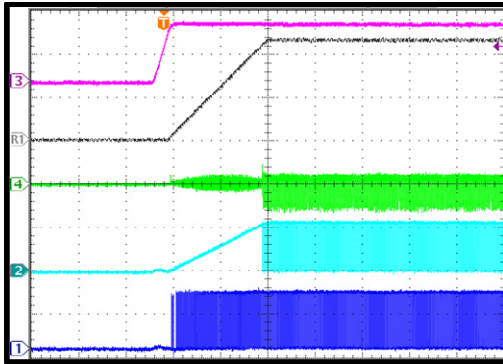

4ms/div.

Start-Up through VIN

$I_{OUT} = 5A$

CH3: V_{IN}
10V/div.
R1: V_{OUT}
5V/div.
CH4: I_L
5A/div.
CH2: V_{SW2}
10V/div.
CH1: V_{SW1}
10V/div.

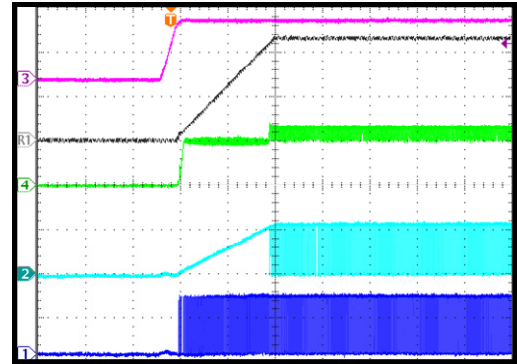

4ms/div.

Shutdown through VIN

$I_{OUT} = 0A$

CH3: V_{IN}
10V/div.
R1: V_{OUT}
5V/div.
CH4: I_L
2A/div.
CH2: V_{SW2}
10V/div.
CH1: V_{SW1}
10V/div.

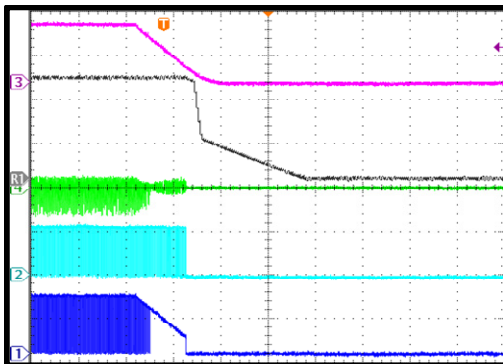

20ms/div.

Shutdown through VIN

$I_{OUT} = 5A$

CH3: V_{IN}
10V/div.
R1: V_{OUT}
5V/div.
CH4: I_L
5A/div.
CH2: V_{SW2}
10V/div.
CH1: V_{SW1}
10V/div.

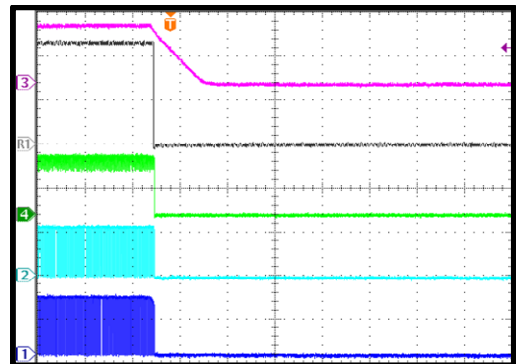

20ms/div.

Start-Up through EN

$I_{OUT} = 0A$

CH3: V_{EN}
2V/div.
R1: V_{OUT}
5V/div.
CH4: I_L
2A/div.
CH2: V_{SW2}
10V/div.
CH1: V_{SW1}
10V/div.

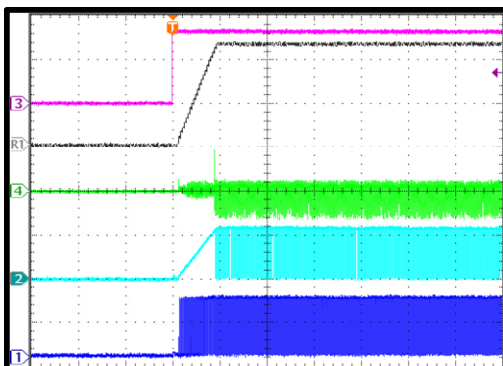

10ms/div.

Start-Up through EN

$I_{OUT} = 5A$

CH3: V_{EN}
2V/div.
R1: V_{OUT}
5V/div.
CH4: I_L
5A/div.
CH2: V_{SW2}
10V/div.
CH1: V_{SW1}
10V/div.

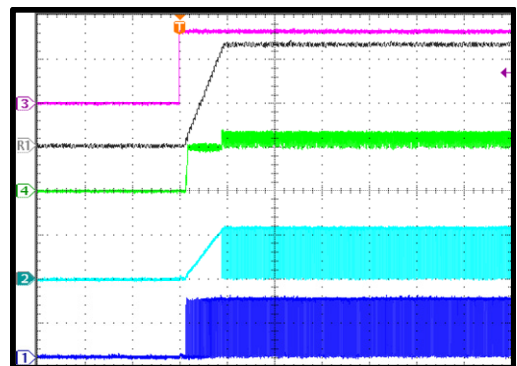

10ms/div.

EVB TEST RESULTS (continued)

$V_{IN} = 13.5V$, $V_{OUT} = 11.5V$, $L = 10\mu H$, $C_{OUT} = 40\mu F$, $f_{SW} = 450kHz$, FCCM, $T_A = 25^\circ C$, unless otherwise noted.

Shutdown through EN
 $I_{OUT} = 0A$

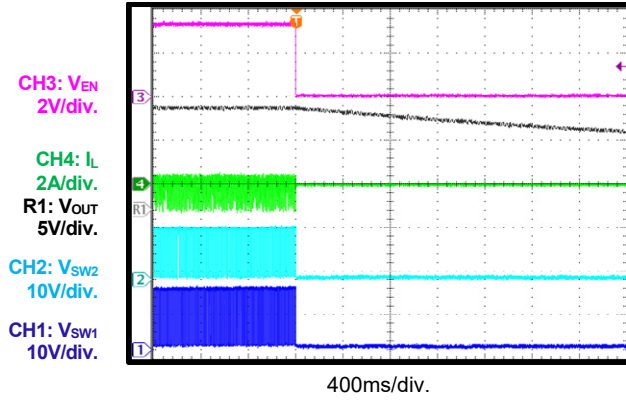

Shutdown through EN
 $I_{OUT} = 5A$

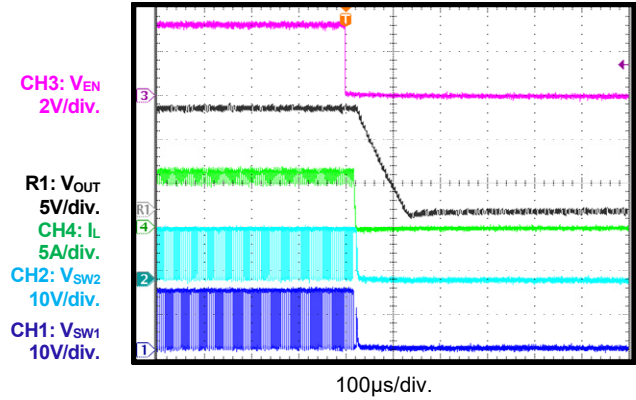

SCP Steady State

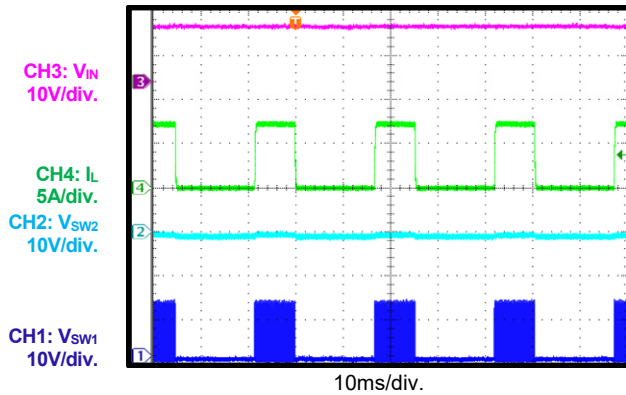

SCP Entry

$I_{OUT} = 0A$ to short circuit

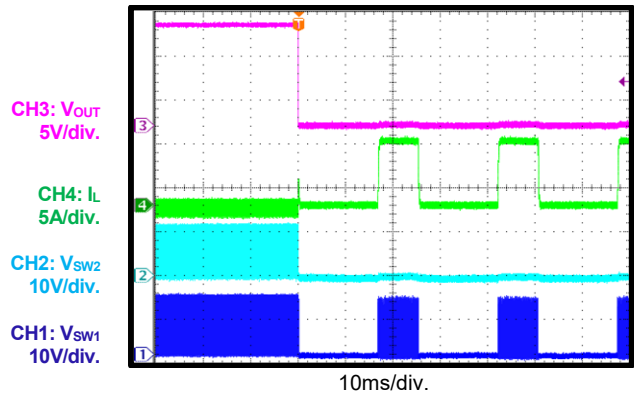

SCP Entry

$I_{OUT} = 5A$ to short circuit

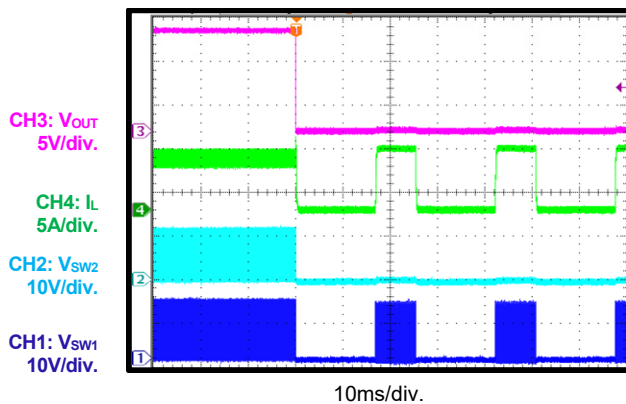

SCP Recovery

Short circuit to $I_{OUT} = 0A$

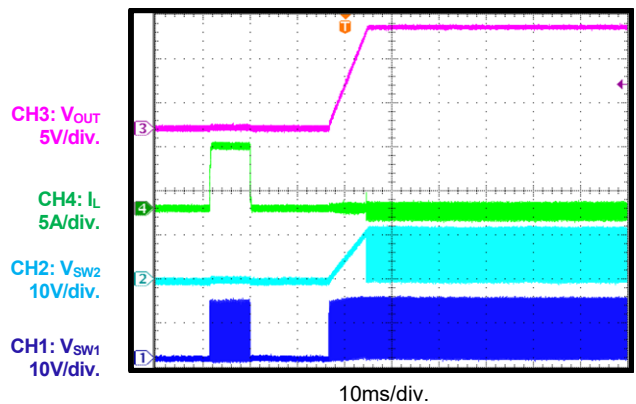

EVB TEST RESULTS (continued)

$V_{IN} = 13.5V$, $V_{OUT} = 11.5V$, $L = 10\mu H$, $C_{OUT} = 40\mu F$, $f_{SW} = 450kHz$, FCCM, $T_A = 25^\circ C$, unless otherwise noted.

SCP Recovery
Short circuit to $I_{OUT} = 5A$

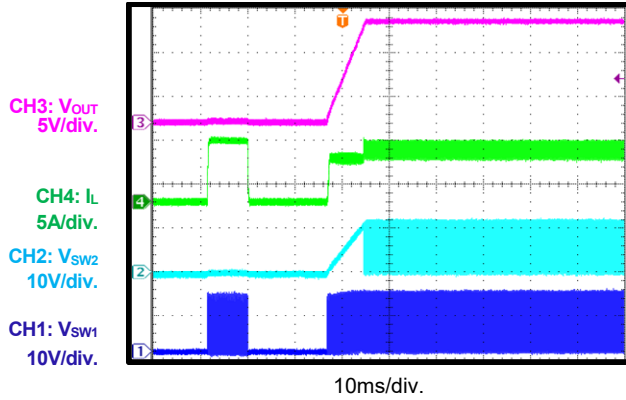

Load Transient
 $I_{OUT} = 2.5A$ to $5A$, $1.6A/\mu s$

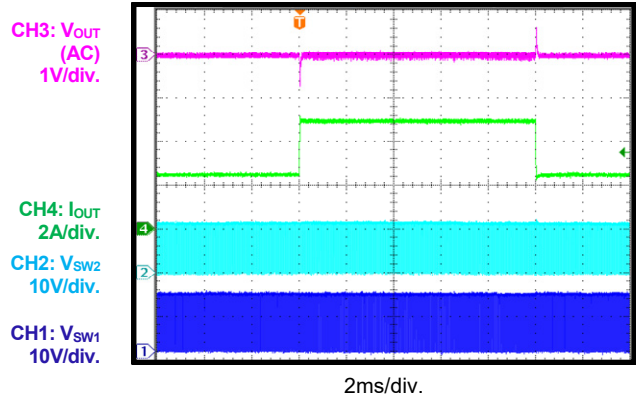

Load Transient
 $I_{OUT} = 0A$ to $2.5A$, $1.6A/\mu s$

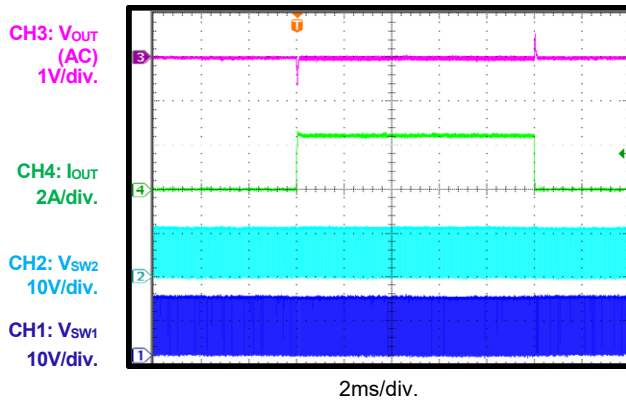

Load Transient
 $I_{OUT} = 0A$ to $5A$, $1.6A/\mu s$

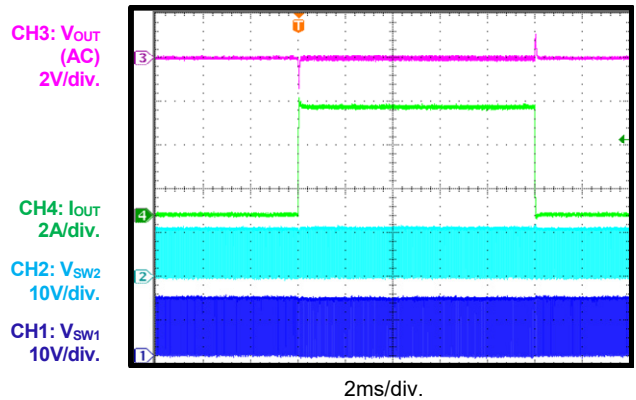

Mode Transient between Boost and Buck-Boost

$V_{IN} = 10V$ to $12V$ to $10V$, $I_{OUT} = 0A$

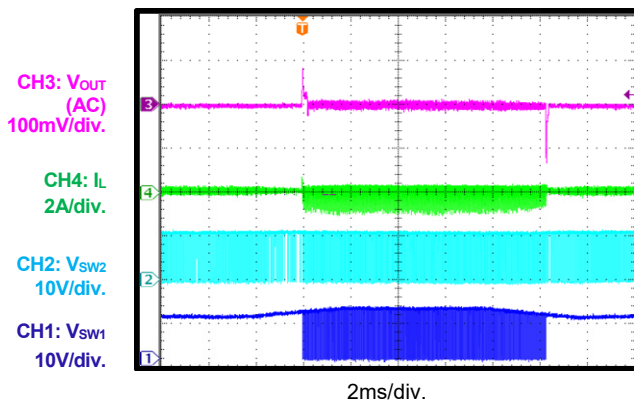

Mode Transient between Boost and Buck-Boost

$V_{IN} = 10V$ to $12V$ to $10V$, $I_{OUT} = 5A$

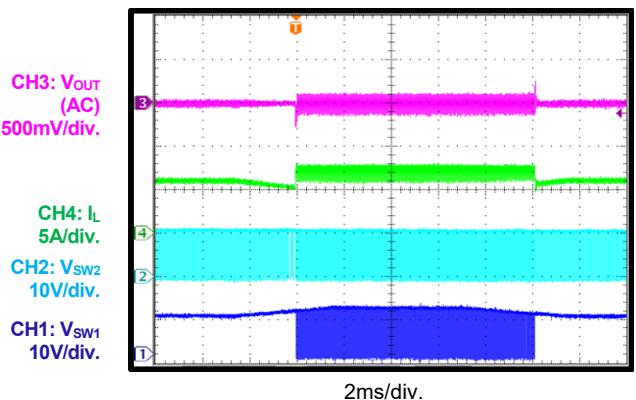

EVB TEST RESULTS (continued)

$V_{IN} = 13.5V$, $V_{OUT} = 11.5V$, $L = 10\mu H$, $C_{OUT} = 40\mu F$, $f_{SW} = 450kHz$, FCCM, $T_A = 25^\circ C$, unless otherwise noted.

Mode Transient between Boost and Buck-Boost

$V_{IN} = 10V$ to $12V$ to $10V$, $I_{OUT} = 3A$

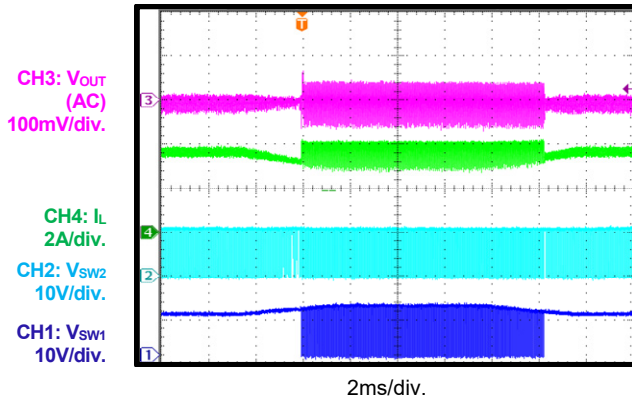

Mode Transient between Buck and Buck-Boost

$V_{IN} = 13.5V$ to $15V$ to $13.5V$, $I_{OUT} = 0A$

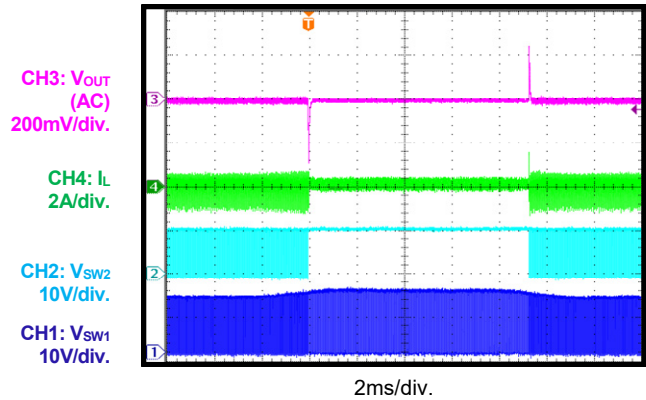

Mode Transient between Buck and Buck-Boost

$V_{IN} = 13.5V$ to $15V$ to $13.5V$, $I_{OUT} = 5A$

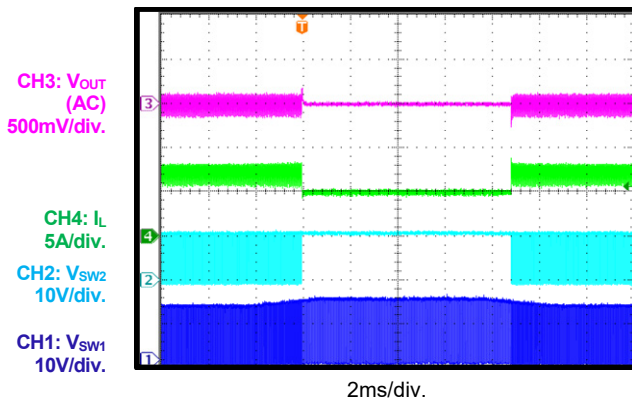

Load Dump

$I_{OUT} = 0A$

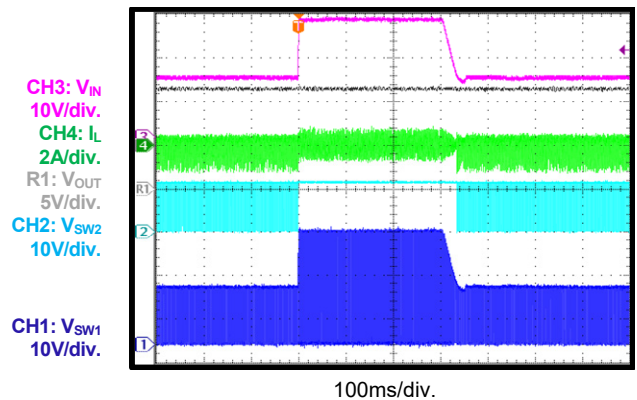

Load Dump

$I_{OUT} = 5A$

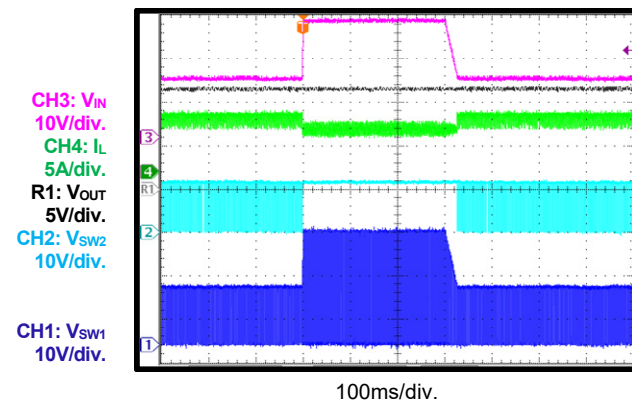

V_{IN} Ramps Down and Up

$I_{OUT} = 0A$

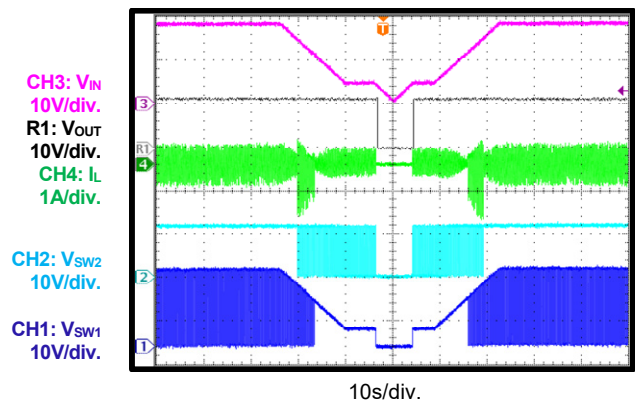

EVB TEST RESULTS (continued)

$V_{IN} = 13.5V$, $V_{OUT} = 11.5V$, $L = 10\mu H$, $C_{OUT} = 40\mu F$, $f_{SW} = 450kHz$, FCCM, $T_A = 25^\circ C$, unless otherwise noted.

V_{IN} Ramps Down and Up
 $I_{OUT} = 1A$

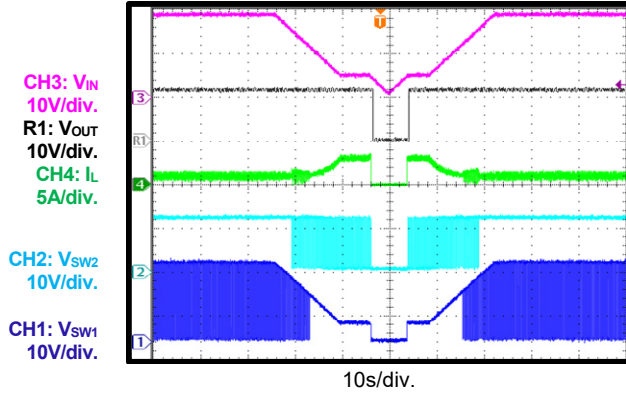

Reset Behavior
 $I_{OUT} = 0A$

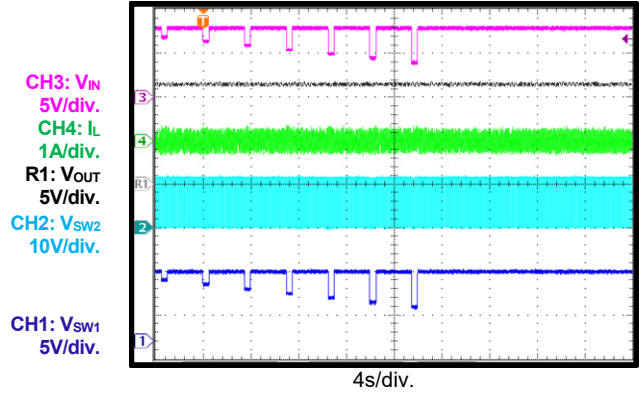

Reset Behavior
 $I_{OUT} = 1A$

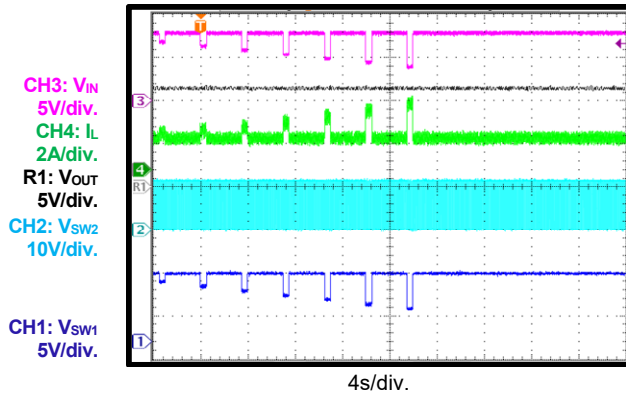

Cold Crank
 $I_{OUT} = 0A$

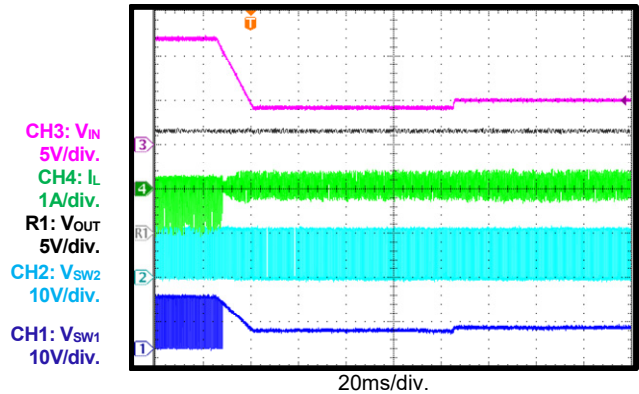

Cold Crank
 $I_{OUT} = 1A$

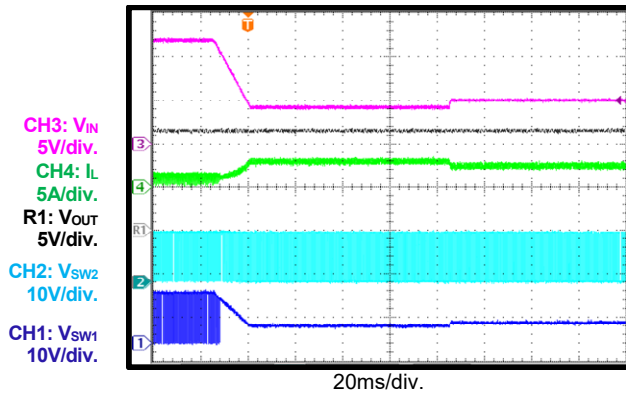

MPQ8875A-0000 DEFAULT REGISTER VALUES

Register Index	Default Value	Description
00h	74h	Reference voltage (V_{REF}): 1.16V
01h	9Ch	Power converter: On V_{OUT} dynamic adjustment step time: 80 μ s V_{OUT} divider ratio: 1/10
02h	55h	SW1 rising slew rate: 2V/ms SW2 rising slew rate: 2V/ms
03h	09h	Synchronization mode: Off f_{SW} : 450kHz
04h	10h	Frequency spread spectrum: Off Frequency spread spectrum modulation range: 5% x f_{sw} Frequency spread spectrum modulation cycle: 250Hz
05h	FFh	DCM/FCCM: FCCM Reverse current limit: -4.7A Valley current limit: 8A Peak current limit: 9A
06h	03h	R_{FB} compensation network: 50k Ω R_{COMP} compensation network: 420k Ω
07h	F3h	C_{HFP} compensation network: 10pF C_{COMP} compensation network: 100pF
08h	11h	I ² C address: 0x01 Cycle extension in buck-boost mode: Off Boost switch duty in buck-boost mode: 30%
09h	A7h	Hysteresis during buck to buck-boost mode transition: 10% x V_{OUT} Threshold during buck-boost to buck mode transition: 125% x V_{OUT} Hysteresis during boost to buck-boost mode transition: 7.5% x V_{OUT} Threshold during boost to buck-boost mode transition: 90% x V_{OUT}
0Ah	00h	Inductor current-sense gain: 13A/V Inductor current-sense DC bias: 200mV Peak to valley ramp compensation: 0.2V Ramp compensation: 12mV/ μ s
0Bh	00h	Power good (PG) high-limit hysteresis: 2.5% x V_{OUT} PG high limit: 110% x V_{OUT} PG low-limit hysteresis: 2.5% x V_{OUT} PG low limit: 90% x V_{OUT} Over-current (OC) timer: 32 / f_{sw} Over-current protection (OCP) mode: Hiccup mode
0Ch	60h	Fault recovery delay time: 16ms Under-voltage protection (UVP) feedback (FB) threshold: 50% x V_{REF} Under-voltage (UV) timer: 2 / f_{sw} UVP mode: Hiccup mode

MPQ8875A-0000 DEFAULT REGISTER VALUES (continued)

Register Index	Default Value	Description
0Dh	00h	V_{IN} over-voltage protection (OVP) hysteresis: $2.5\% \times V_{IN}$ V_{IN} OVP threshold: Off V_{OUT} OVP recovery threshold: $105\% \times V_{REF}$ V_{OUT} OVP threshold: $110\% \times V_{REF}$ VFB pin connection mode: Disconnected OVP mode: Hiccup mode
0Eh	02h	Thermal shutdown hysteresis: 25°C Thermal shutdown: 170°C

PCB LAYOUT

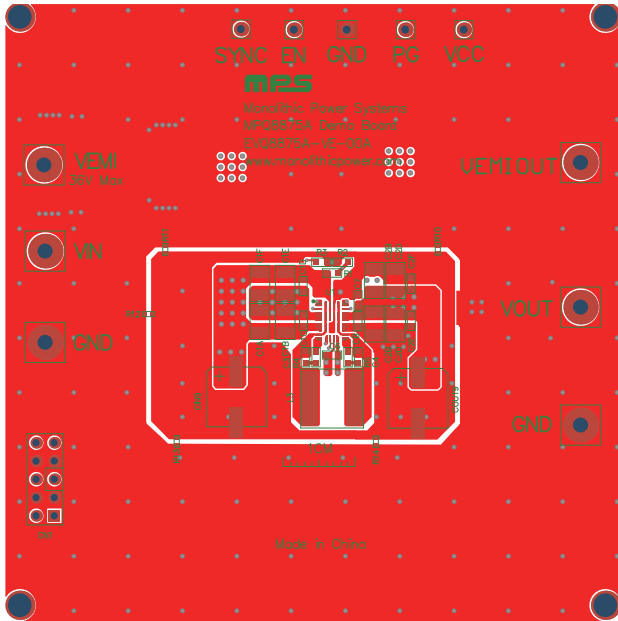

Figure 2: Top Silk and Top Layer

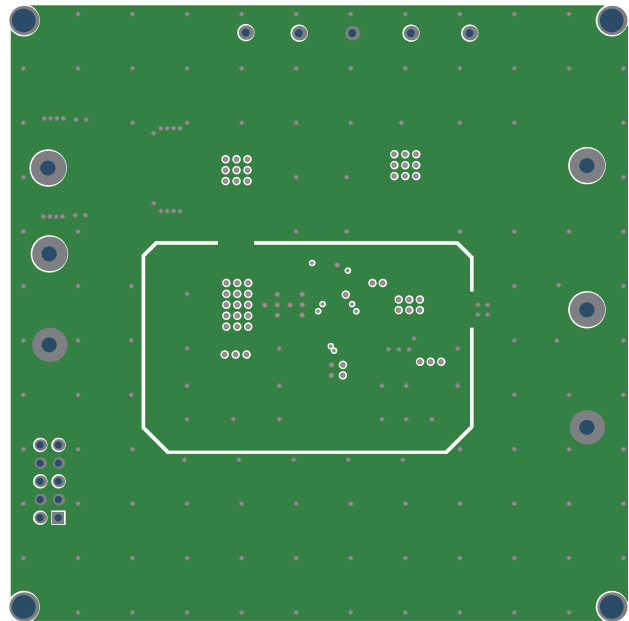

Figure 3: Mid-Layer 1

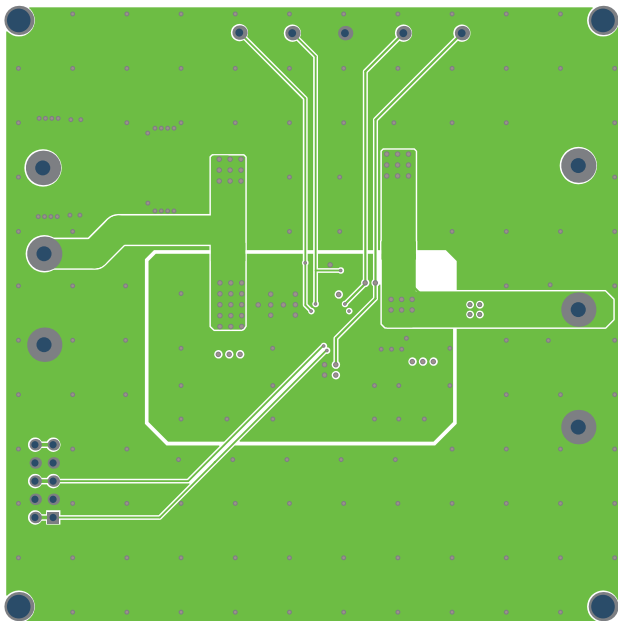

Figure 4: Mid-Layer 2

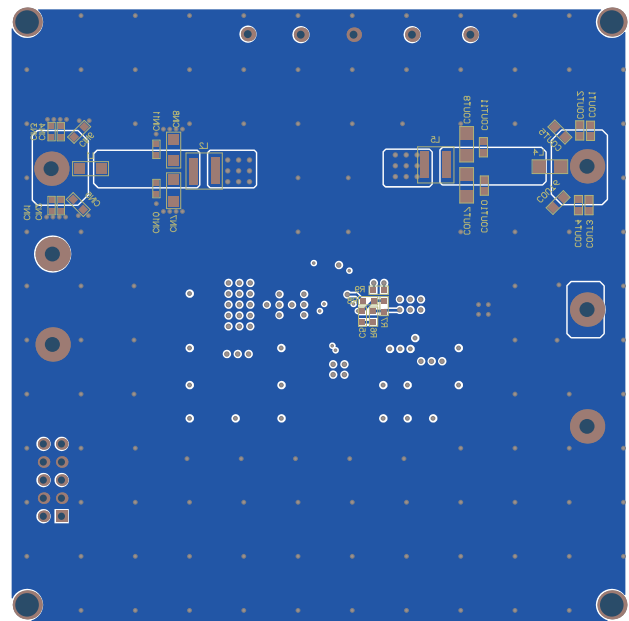

Figure 5: Bottom Layer and Bottom Silk



REVISION HISTORY

Revision #	Revision Date	Description	Pages Updated
1.0	4/9/2021	Initial Release	-

Notice: The information in this document is subject to change without notice. Please contact MPS for current specifications. Users should warrant and guarantee that third-party Intellectual Property rights are not infringed upon when integrating MPS products into any application. MPS will not assume any legal responsibility for any said applications.