



EV8634B-LE-00A

High Efficiency 16V, 20A Synchronous Step-Down Converter Evaluation Board

DESCRIPTION

The EVQ8634B-LE-00A is an evaluation board for the MPQ8634B, a high efficiency, monolithic, synchronous step-down converter.

The EV board can deliver 20A continuous load current over a wide operating input range. High efficiency can be achieved over a wide output current load range.

The MPQ8634B adopts internally compensated constant-on-time (COT) control mode that provides fast transient response and eases loop stabilization.

This EV board can be turned on or off via a remote ON/OFF input (EN) that is referenced to ground. This input is compatible with popular logic devices.

ELECTRICAL SPECIFICATION

Parameter	Symbol	Value	Units
Input Voltage	V_{IN}	8-16	V
Output Voltage	V_{OUT}	1	V
Output Current	I_{OUT}	20	A

FEATURES

- Wide Input Voltage Range from 2.7V:
 - 2.7V to 16V with External 3.3V VCC Bias
 - 4V to 16V with Internal VCC Bias or External 3.3V VCC Bias
- Differential Output Voltage Remote Sense
- Programmable Accurate Current Limit Level
- 20A Output Current
- Low $R_{DS(ON)}$ Integrated Power MOSFETs
- Proprietary Switching Loss Reduction Technique

- Adaptive COT for Ultrafast Transient Response
- Stable with Zero-ESR Output Capacitor
- 0.5% Reference Voltage Over 0°C to +70°C Junction Temperature Range
- 1% Reference Voltage Over -40°C to +125°C Junction Temperature Range
- Selectable Pulse-Skip or Forced-CCM Operation
- Excellent Load Regulation
- Output Voltage Tracking
- Output Voltage Discharge
- PGOOD Active Clamped Low Level during Power Failure
- Programmable Soft Start Time from 1ms
- Pre-Bias Start up
- Selectable Switching Frequency of 600kHz, 800kHz and 1000kHz
- Non-latch OCP, UVP, UVLO, Thermal Shutdown, and Latch-off for OVP
- Output Adjustable from 0.9V to 90%* V_{in} , Up to 5.5V max.
- Available in a QFN3X4 mm Package

APPLICATIONS

- Telecom System and Networking Systems
- Servers, Cloud-Computing, Storage
- Base Stations
- General Purpose Point-of-Load (PoL)
- 12V Distribution Power Systems
- High-end TV
- Game Consoles and Graphic Cards

All MPS parts are lead-free, halogen free, and adhere to the RoHS directive. For MPS green status, please visit MPS website under Quality Assurance.

"MPS" and "The Future of Analog IC Technology" are Registered Trademarks of Monolithic Power Systems, Inc.

EV8634B-LE-00A EVALUATION BOARD

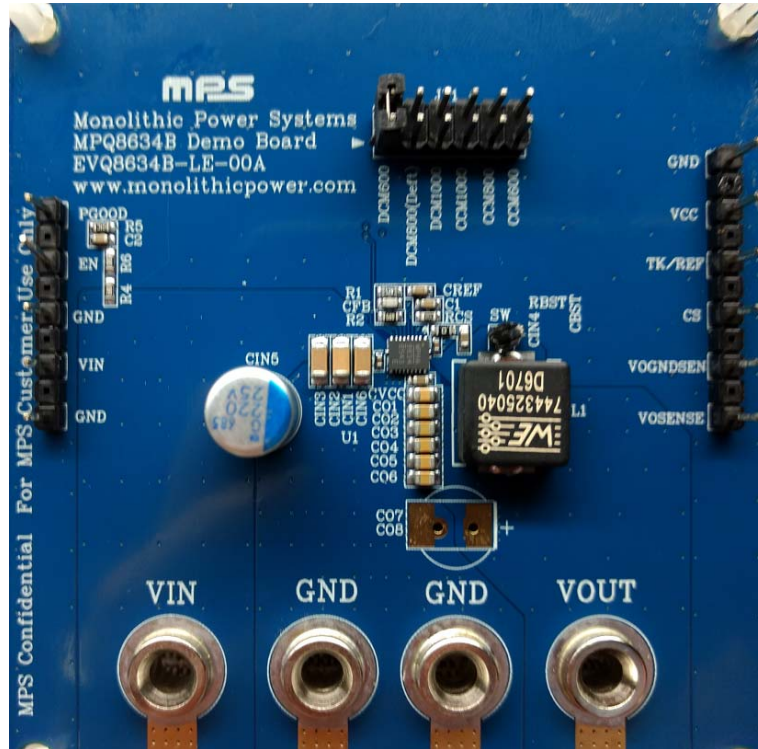

(L x W x H) 81.3 mm x 77.5mm x 1.6 mm

Board Number	MPS IC Number
EVQ8634B-LE-00A	MPQ8634BGLE

EVALUATION BOARD SCHEMATIC

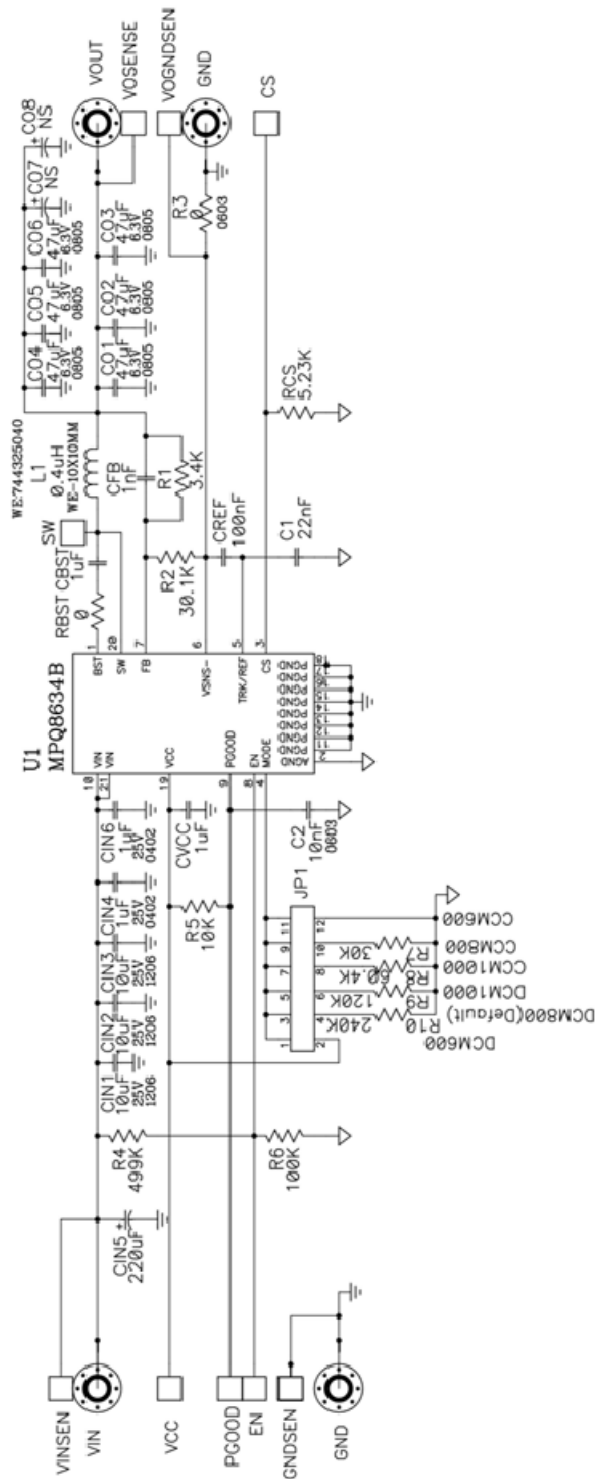

BILL OF MATERIALS

Qty	Ref	Value	Description	Package	Manufacturer	Part Number
1	C1	22nF	CAP, 25V, 10%, X7R	CAP0603	Generic	
1	C2	10nF	CAP CER 1nF 25V 10% X7R 0603	CAP0603	Generic	
2	CBST, CVCC	1µF	CAP CER 1µF 6.3V 10% X7R 0603	CAP0603	Generic	
1	CFB	1nF	CAP, 50V, 10%, X7R	CAP0603	Generic	
3	CIN1, CIN2, CIN3	10µF	Capacitor, 25V, X7R, 10%	CAP1206	Murata or Generic	GRM31CR71E106KA12L
2	CIN4, CIN6	1µF/25V	CAP CER 1µF 25V 10% X6S 0402	CAP0402	Murata or Generic	GRM155C81E105KE11D
1	CIN5	220µF	220µF, 25V, 16mΩ ESR	D8P3.5mm	Chemi-Con or Generic	APSG250ELL221MHB5S
6	CO1, CO2, CO3, CO4, CO5, CO6	47µF	CAP, 6.3V, X5R, 20%	CAP0805	Murata or Generic	GRM21BR60J476ME15L
1	CO7	NS		D2		
1	CO8	NS		D8P3.5mm		
1	CREF	100nF	CAP CER 0.1µF 25V 10% X7R 0603	CAP0603	Generic	
1	L1	0.4µH	Inductor	10x10mm	Würth or Generic	WE-744325040
1	R1	3.4K	Film Res., 1%	0603	Generic	
1	R2	30.1k	Film Res., 1%	0603	Generic	
2	R3, RBST	0	Film Res., 5%	0603	Generic	
1	R4	499K	Film Res., 1%	0603	Generic	
1	R5	10K	Film Res., 1%	0603	Generic	
1	R6	100K	Film Res., 1%	0603	Generic	
1	R7	30K	Film Res., 1%	0603	Generic	
1	R8	60.4K	Film Res., 1%	0603	Generic	
1	R9	120K	Film Res., 1%	0603	Generic	
1	R10	240K	Film Res., 1%		Generic	
1	RCS	5.23K	Film Res., 1%	0603	Generic	
1	U1	MPQ8634BGL E	16V/20A Step Down Converter	QFN21-3x4mm	MPS	MPQ8634BGLE

EVB TEST RESULTS

Performance waveforms are tested on the EV8634B-LE-00A evaluation board.

$V_{IN} = 12V$, $V_{OUT} = 1V$, $L = 400nH$, $T_A = +25^{\circ}C$, unless otherwise noted.

Efficiency

Pulse Skip, 0.4 μ H, 800kHz

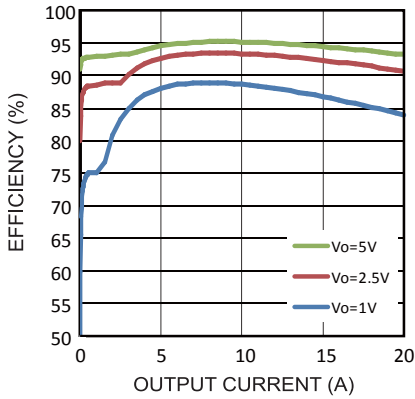

Efficiency

Forced CCM, 0.4 μ H, 800kHz

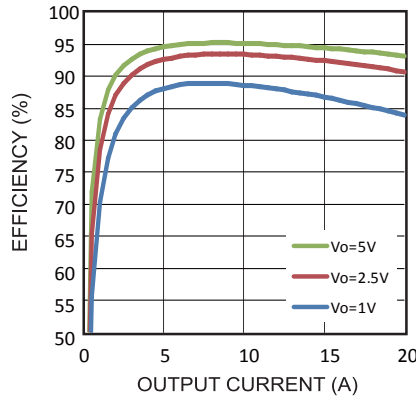

Thermal Results

800kHz, no Air-flow

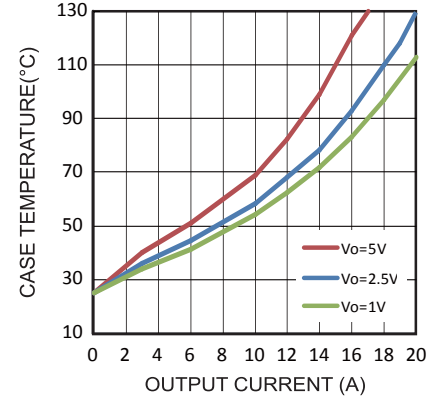

Switching Frequency vs. Output Current

Forced CCM

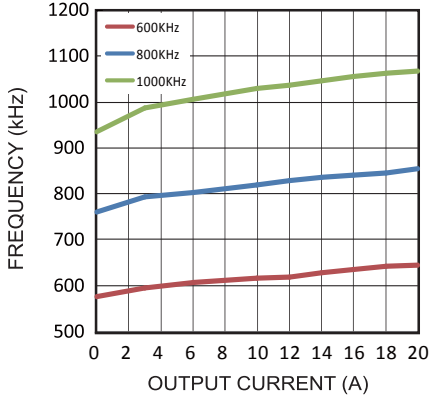

Output Voltage Load Regulation

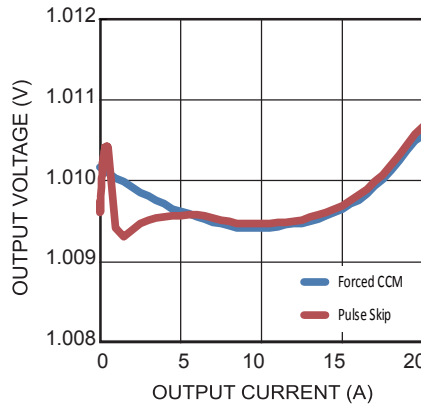

Switching Frequency vs. Input Voltage

$V_{OUT} = 1V$, 3A Load

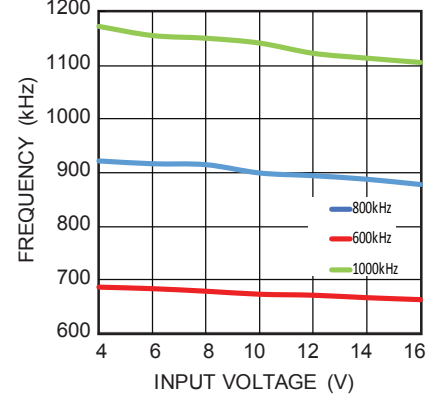

Switching Frequency vs. Output Voltage

$V_{OUT} = 12V$, 3A Load

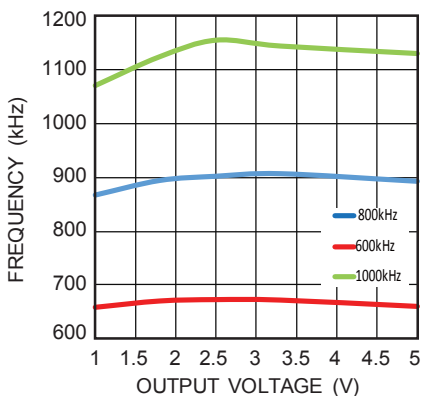

EVB TEST RESULTS (continued)

Performance waveforms are tested on the EVQ8634B-LE-00A evaluation board.

 $V_{IN} = 12V$, $V_{OUT} = 1V$, $L = 400nH$, $T_A = +25^{\circ}C$, unless otherwise noted.

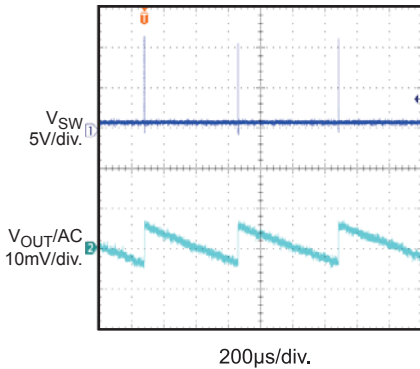
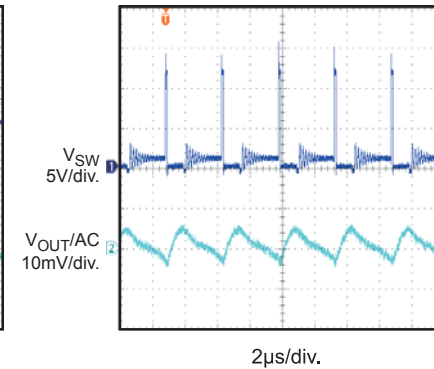
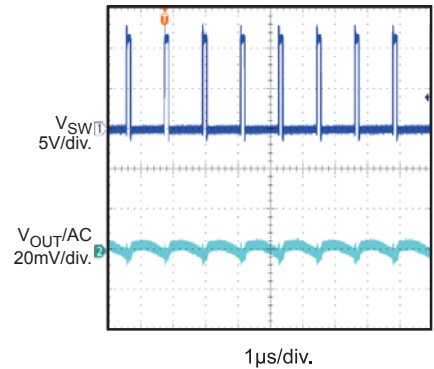
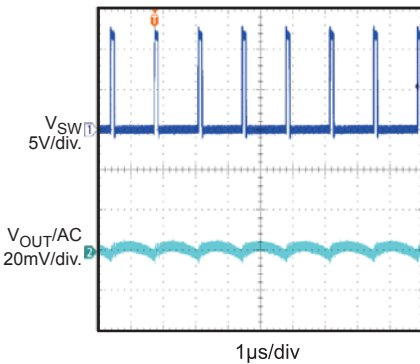
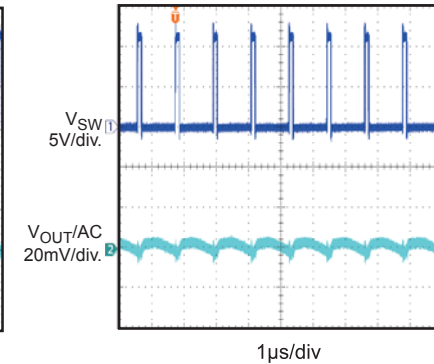
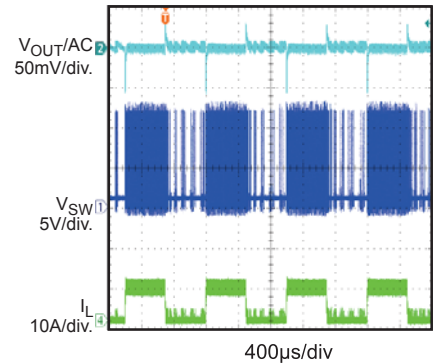
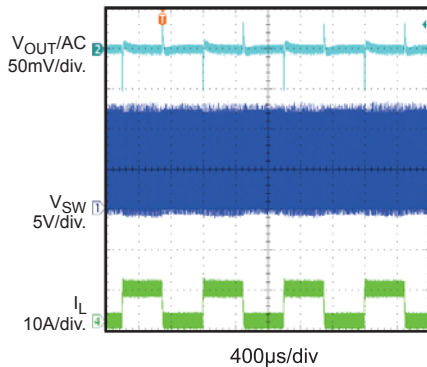
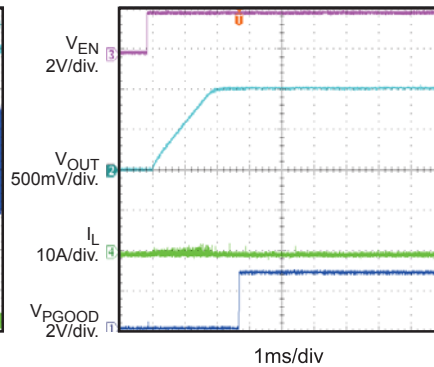
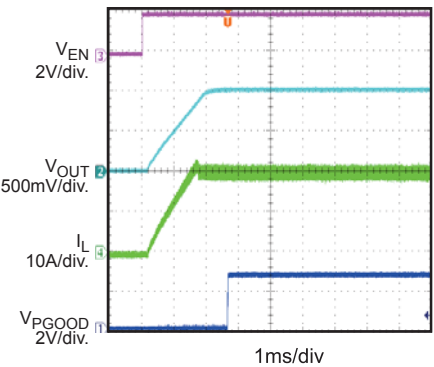
Steady State
 $I_{OUT} = 0A$, Pulse Skip

Steady State
 $I_{OUT} = 0.5A$, Pulse Skip

Steady State
 $I_{OUT} = 20A$, Pulse Skip

Steady State
 $I_{OUT} = 0A$, Forced CCM

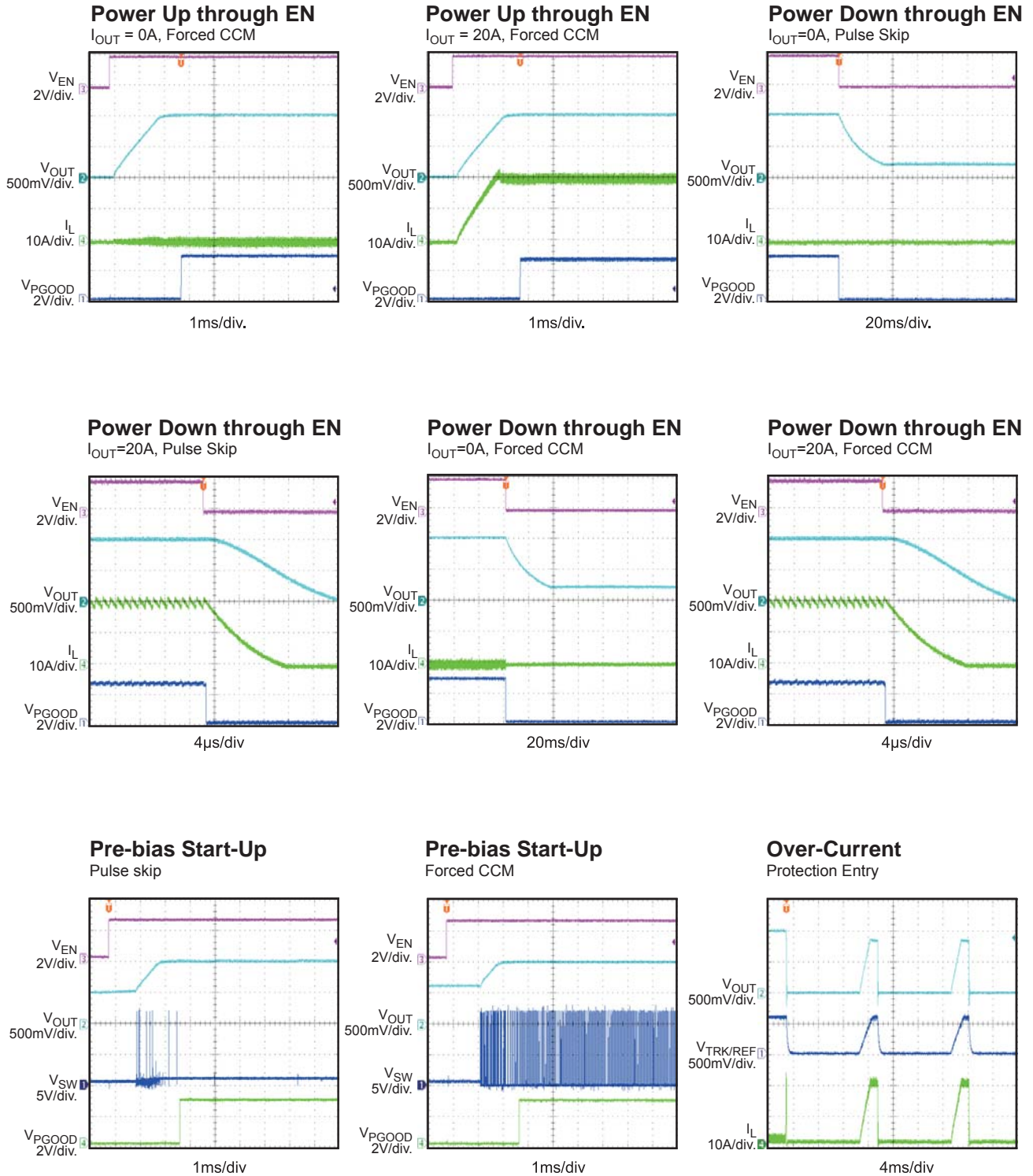
Steady State
 $I_{OUT} = 20A$, Forced CCM

Load Transient
 $I_{OUT} = 0A \sim 8A$, Pulse Skip

Load Transient
 $I_{OUT} = 0A \sim 8A$, Forced CCM

Power Up through EN
 $I_{OUT} = 0A$, Pulse Skip

Power Up through EN
 $I_{OUT} = 20A$, Pulse Skip

EVB TEST RESULTS (continued)

Performance waveforms are tested on the EVQ8634B-LE-00A evaluation board.

$V_{IN} = 12V$, $V_{OUT} = 1V$, $L = 400nH$, $T_A = +25^{\circ}C$, unless otherwise noted.



EVB TEST RESULTS *(continued)*

Performance waveforms are tested on the EVQ8634B-LE-00A evaluation board.

$V_{IN} = 12V$, $V_{OUT} = 1V$, $L = 400nH$, $T_A = +25^{\circ}C$, unless otherwise noted.

Over-Current
Protection Recovery

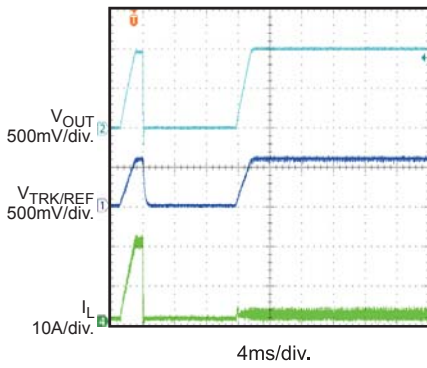

OSM Operation
Pulse Skip Mode

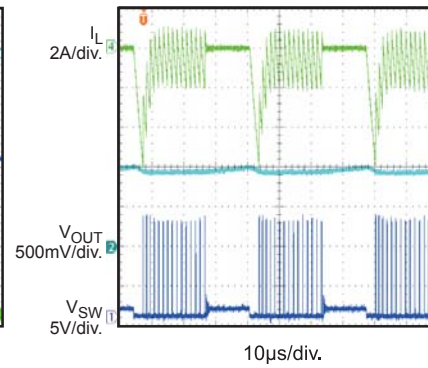

Over-voltage Protection
Pulse Skip Mode

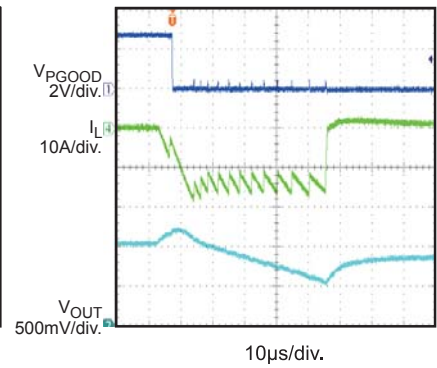

Over-voltage Protection
Forced CCM

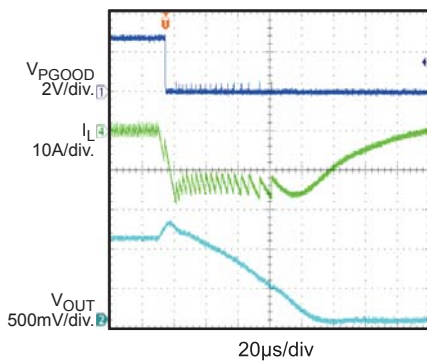

PRINTED CIRCUIT BOARD LAYOUT

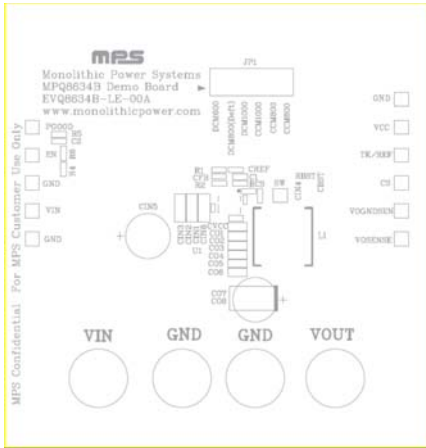

Figure 1—Top Silk Layer

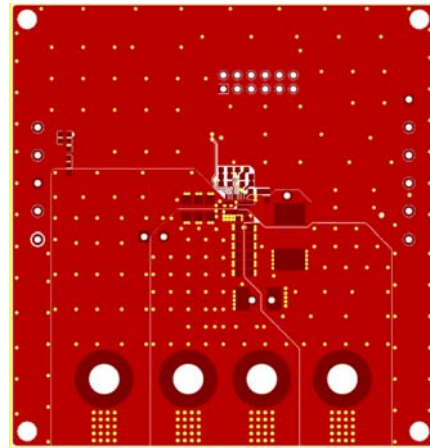

Figure 2—Top Layer

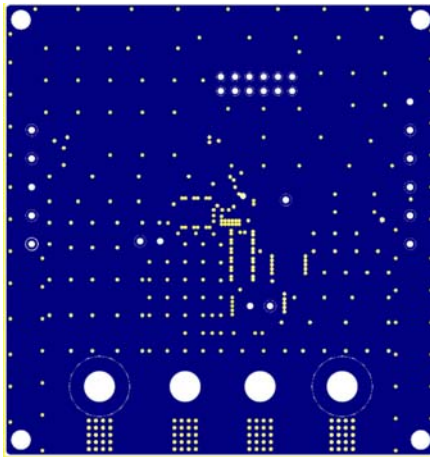

Figure 3—Inner Layer 1

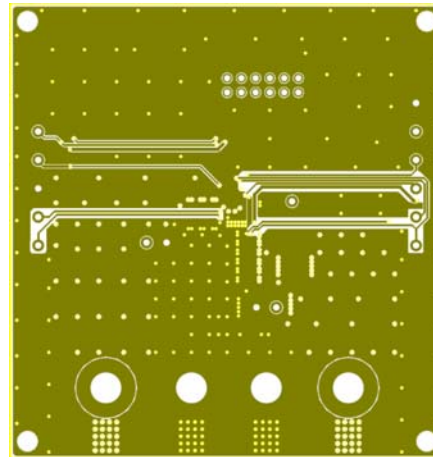

Figure 4— Inner Layer 2

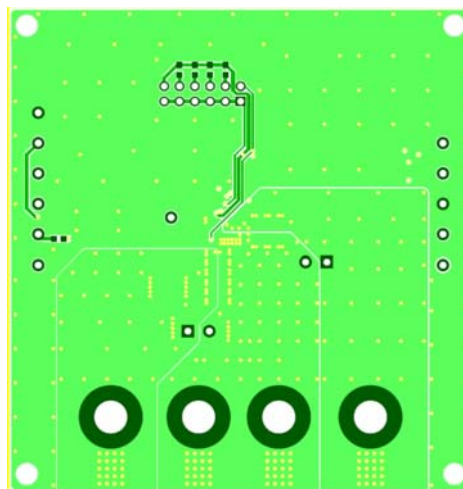

Figure 5—Bottom Layer

QUICK START GUIDE

The input voltage of the EV board can range from 8V to 16V. The minimum 8V input voltage is limited by the EN signal, which is derived from VIN through a resistor divider (R4 and R6). Lower input voltage (as low as 2.7V) can be set by fine tuning the resistor divider values, or by over-driving the EN with an external control signal. The following is the procedure to turn on the EV board.

1. Connect the positive and negative terminals of the load to the VOUT and GND pins, respectively.
2. Preset the power supply output voltage between 8V and 16V, and then turn off the power supply.
3. Connect the positive and negative terminals of the power supply output to the VIN and GND pins, respectively. Make sure the power supply has high enough current limit to supply the power.
4. Turn the power supply on. The EVQ8634B-LE-00A will automatically startup.
5. To use the Enable function, apply a digital input to the EN pin. Drive EN higher than 1.5V to turn on the regulator or less than 1V to turn it off.
6. Use R1 and R2 to set the output voltage with $V_{FB} = 0.9 \text{ V}$. Follow the Application Information section in the device datasheet to select the proper values of R1, R2, inductor and output capacitor values when output voltage is changed.
7. The JP1 jumper can be used to select the operating frequency (600KHz, 800KHz and 1000KHz) and light load operation mode (Pulse Skip/DCM and CCM).

NOTICE: The information in this document is subject to change without notice. Please contact MPS for current specifications. Users should warrant and guarantee that third party Intellectual Property rights are not infringed upon when integrating MPS products into any application. MPS will not assume any legal responsibility for any said applications.