



The Future of Analog IC Technology®

EVQ8616-L-6-00A

High Efficiency, 6A, 6V
Synchronous Step-down Converter
Evaluation Board

DESCRIPTION

The EVQ8616-L-6-00A is an evaluation board for the MPQ8616GL-6, a high efficiency monolithic synchronous step-down converter.

The Evaluation Board can deliver 6A continuous load current from a 3V to 6V input with excellent load and line regulation.

Constant-On-Time (COT) control mode provides fast transient response and eases loop stabilization.

The Evaluation Board can be turned on or shut down via a remote ON/OFF input that is reference to ground. This input is compatible with popular logic devices.

ELECTRICAL SPECIFICATION

Parameter	Symbol	Value	Units
Input Voltage	V_{IN}	3 – 6	V
Output Voltage	V_{OUT}	1.2	V
Output Current	I_{OUT}	6	A
Switching Frequency	f_{sw}	600	kHz

FEATURES

- Wide 3V to 6V Operating Input Range
- 6A Output Current
- 19.8m Ω /15.3m Ω Internal Power MOSFETs
- Proprietary Switching Loss Reduction Technique
- Adaptive COT for Ultrafast Transient Response
- 1% Reference Voltage Over -20 to +85 Junction Temperature Range
- Programmable Soft Start Time
- Pre-Bias Start up
- Programmable Switching Frequency from 300kHz to 1MHz.
- Non-Latch OCP, Non-Latch OVP Protection and Thermal Shutdown
- Available in a QFN3x4 package

APPLICATIONS

- Telecom System Base Station
- Networking System
- Server
- Personal Video Recorders
- Flat Panel Television and Monitors
- Distributed Power Systems

All MPS parts are lead-free, halogen free, and adhere to the RoHS directive. For MPS green status, please visit MPS website under Quality Assurance. "MPS" and "The Future of Analog IC Technology" are Registered Trademarks of Monolithic Power Systems, Inc.

EVQ8616-L-6-00A EVALUATION BOARD

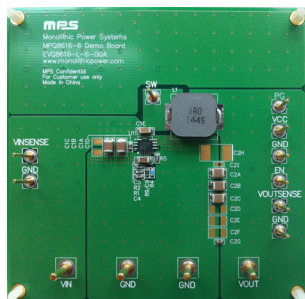

(L x W x H) 8.55cm x 8.55cm x 1.6cm

Board Number	MPS IC Number
EVQ8616-L-6-00A	MPQ8616GL-6

Efficiency

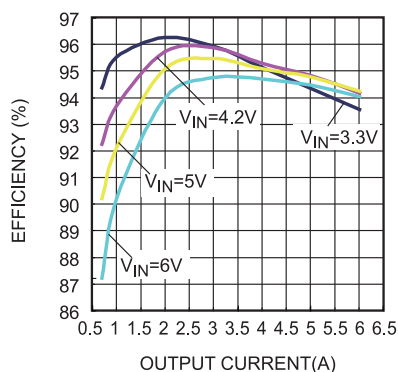

EVALUATION BOARD SCHEMATIC

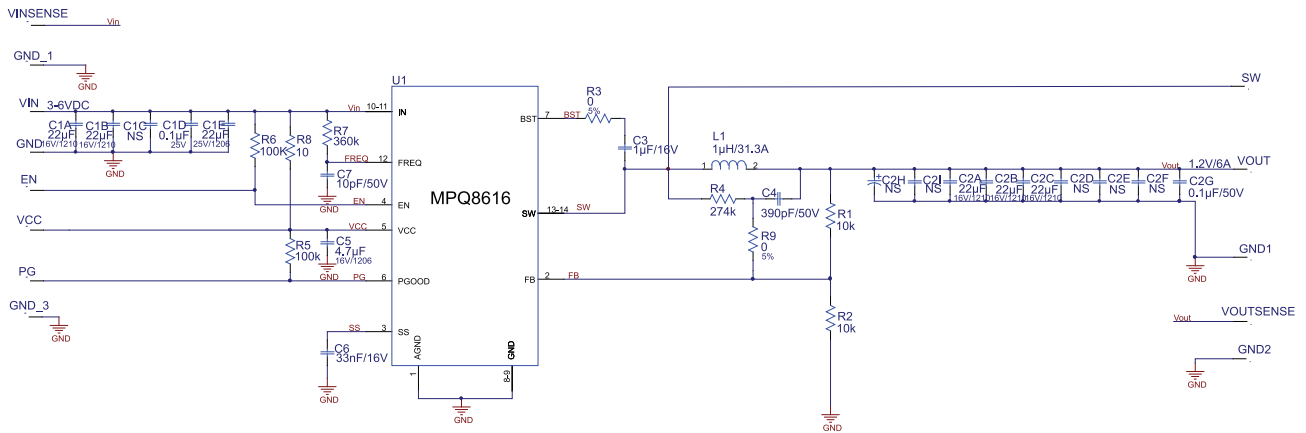

EVQ8616-L-6-00A BILL OF MATERIALS

Qty	Ref	Value	Description	Package	Manufacture	Part Number
7	C1A, C1B, C1C, C2A, C2B, C2C, C2D	22µF	Ceramic Capacitor; 16V;X7R;	1210	Murata	GRM32ER71C226KE18L
2	C1D, C2G	0.1µF	Ceramic Capacitor; 50V;X7R;0603;	0603	Murata	GRM188R71H104KA93D
1	C1E	22µF	Ceramic Capacitor; 25V;X5R	1206	Murata	GRM31CR61E226KE15
4	C2E, C2F, C2H,C2I	NS	Ceramic Capacitor; 16V;X7R;	1210	Murata	GRM32ER71C226KE18L
1	C3	1µF	Ceramic Capacitor; 16V;X7R;0603;	0603	Murata	GRM188R71C105KA12D
1	C4	390pF	Ceramic Capacitor; 50V;X7R;0603	0603	LION	0603B391K500T
1	C5	4.7µF	Ceramic Capacitor; 16V;X7R;1206	1206	Murata	GRM31CR71C475KA01
1	C6	33nF	Ceramic Capacitor; 16V;X7R;0603;	0603	Murata	GRM188R71C333KAO1D
1	C7	10pF	Ceramic Capacitor; 50V;X7R;0603;	0603	Murata	GRM1885C1H100JA01

EVQ8616-L-6-00A BILL OF MATERIALS *(continued)*

Qty	Ref	Value	Description	Package	Manufacture	Part Number
9	EN, GND2, GND_1, GND_3, PG, SW, VCC, VINSENSE, VOUTSENSE		Connector	CONN/1M M		
4	GND, GND1, VIN, VOUT		Connector	CONN/2M M		
1	L1	1 μ H	Inductor;1 μ H; 1.72mOhm;31.3A	SMD	TOKO	FDU1250C-1R0M
2	R1, R2	10k	Film Resistor;1%;	0603	Yageo	RC0603FR-0710KL
2	R3, R9	0	Film Resistor;5%;	0603	Yageo	RC0603JR-070RL
1	R4	274k	Film Resistor;1%;	0603	Yageo	RC0603FR-07274KL
2	R5, R6	100k	Film Resistor;1%;	0603	Yageo	RC0603FR-07100KL
1	R7	360k	Film Resistor;1%;	0603	Yageo	RC0603FR-07360KL
1	R8	10	Film Resistor;1%;	0603	Yageo	RC0603FR-0710RL
1	U1		Step Down Converter	QFN 3X4	MPS	MPQ8616GL-6

EVB TEST RESULTS

Performance waveforms are tested on the EVQ8616-L-6-00A.

$V_{IN} = 5V$, $V_{OUT} = 1.2V$, $L = 1.0\mu H$, $T_A = 25^\circ C$, unless otherwise noted.

Efficiency

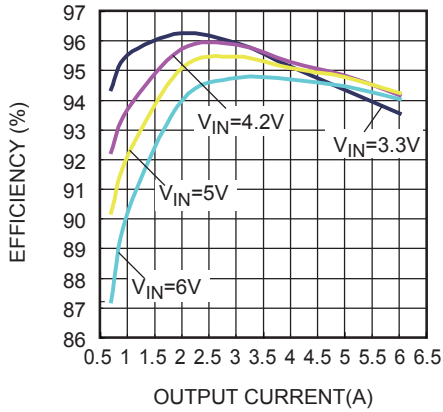

Power Loss

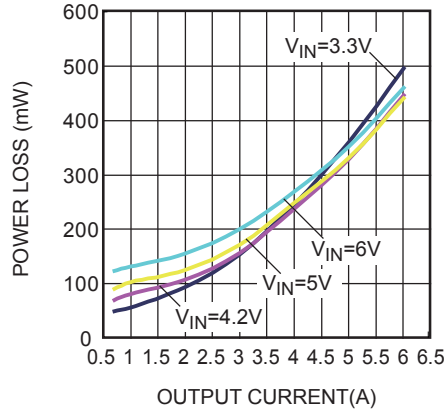

Load Regulation

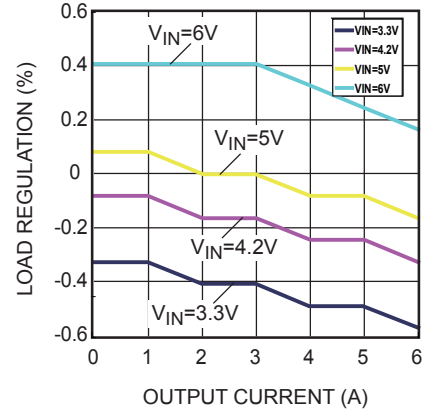

Line Regulation

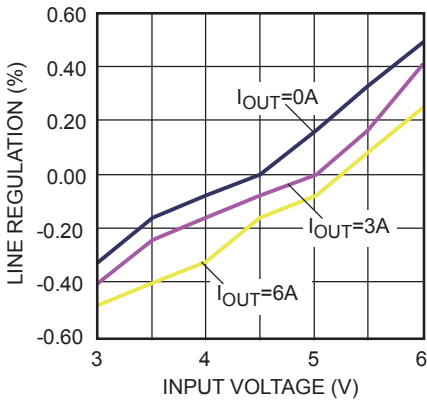

EVB TEST RESULTS (continued)

Performance waveforms are tested on the EVQ8616-L-6-00A.

$V_{IN} = 5.0V$, $V_{OUT} = 1.2V$, $L = 1.0\mu H$, $T_A = 25^\circ C$, unless otherwise noted.

Input/Output Voltage Ripple
 $I_{OUT} = 0A$

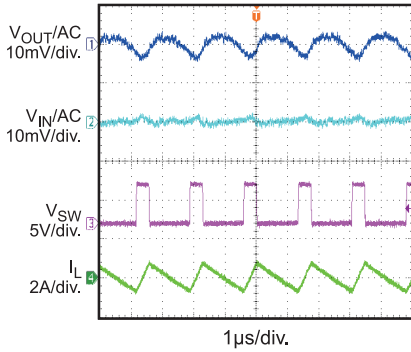

Input/Output Voltage Ripple
 $I_{OUT} = 0.3A$

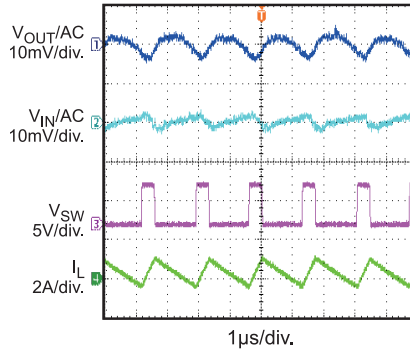

Input/Output Voltage Ripple
 $I_{OUT} = 6A$

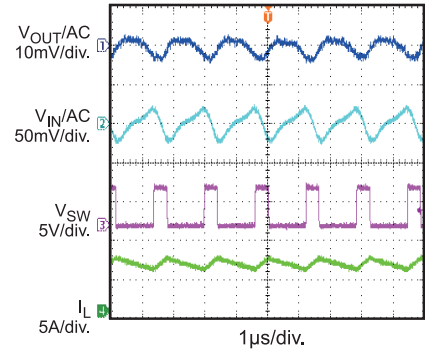

Power Good Through V_{IN} Start-Up
 $I_{OUT} = 6A$

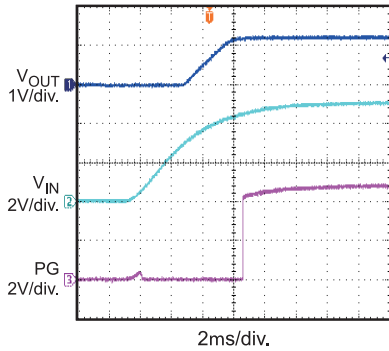

Power Good Through Shutdown
 $I_{OUT} = 6A$

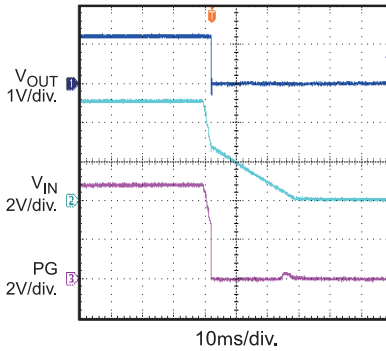

Power Good Through EN Start-Up
 $I_{OUT} = 6A$

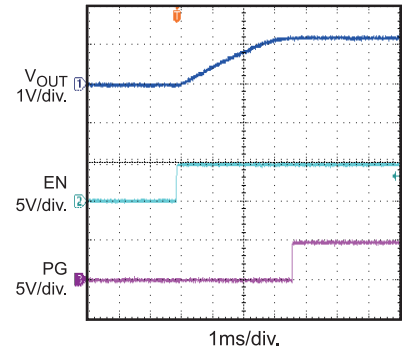

Power Good Through EN Shutdown
 $I_{OUT} = 6A$

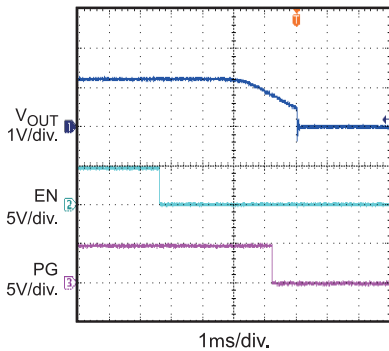

Start-Up Through V_{IN}
 $I_{OUT} = 0A$

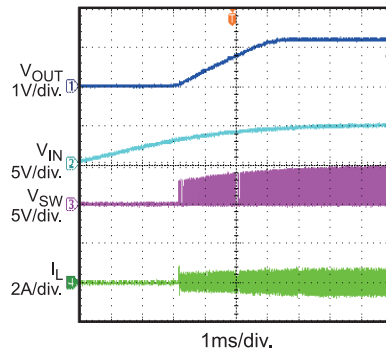

Start-Up Through V_{IN}
 $I_{OUT} = 6A$

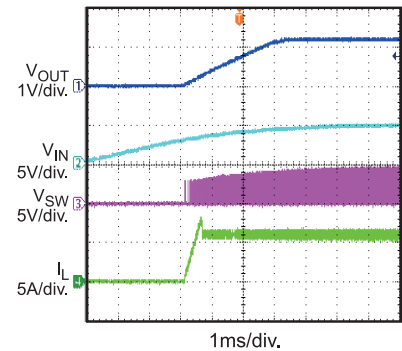

EVB TEST RESULTS (continued)

Performance waveforms are tested on the EVQ8616-L-6-00A.

$V_{IN} = 5.0V$, $V_{OUT} = 1.2V$, $L = 1.0\mu H$, $T_A = 25^\circ C$, unless otherwise noted.

Shutdown Through V_{IN}
 $I_{OUT} = 0A$

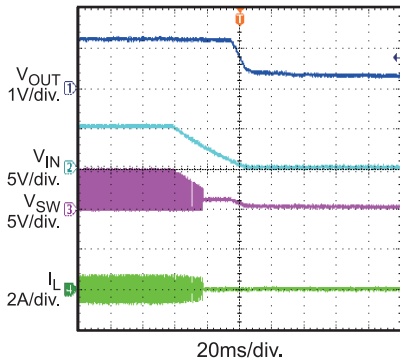

Shutdown Through V_{IN}
 $I_{OUT} = 6A$

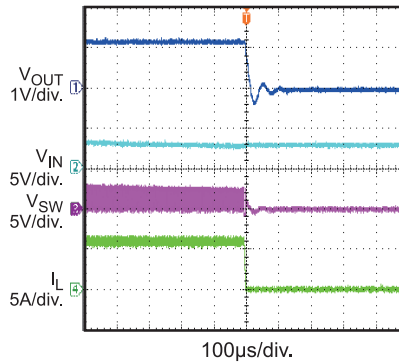

Start-Up Through EN
 $I_{OUT} = 0A$

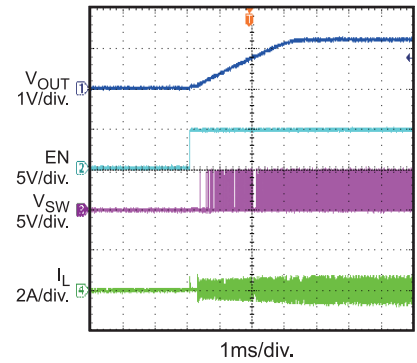

Start-Up Through EN
 $I_{OUT} = 6A$

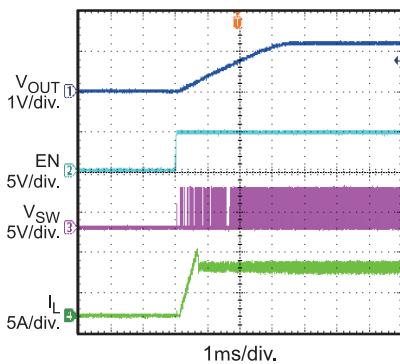

Shutdown Through EN
 $I_{OUT} = 0A$

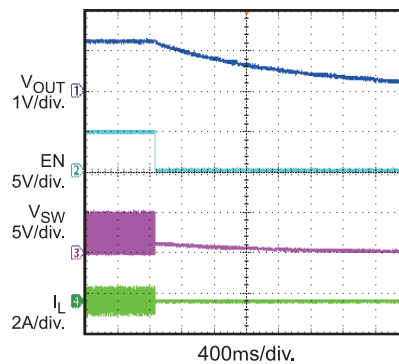

Shutdown Through EN
 $I_{OUT} = 6A$

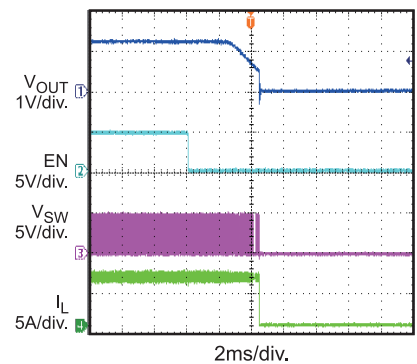

Transient

$I_{OUT} = 0.6A - 5.4A @ 2.5A/\mu s$,
 $f_{SW} = 600kHz$, $C_{OUT} = 4 \times 22\mu F$

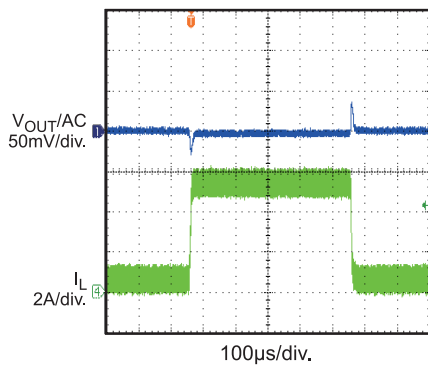

Short Circuit Protection

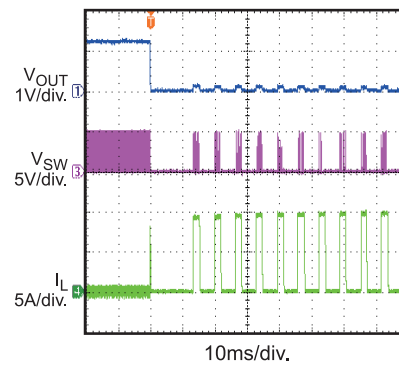

Thermal Shutdown

$I_{OUT} = 6A$

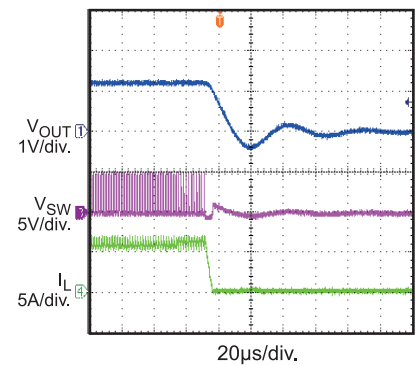

EVB TEST RESULTS *(continued)*

Performance waveforms are tested on the EVQ8616-L-6-00A.

$V_{IN} = 5.0V$, $V_{OUT} = 1.2V$, $L = 1.0\mu H$, $T_A = 25^\circ C$, unless otherwise noted.

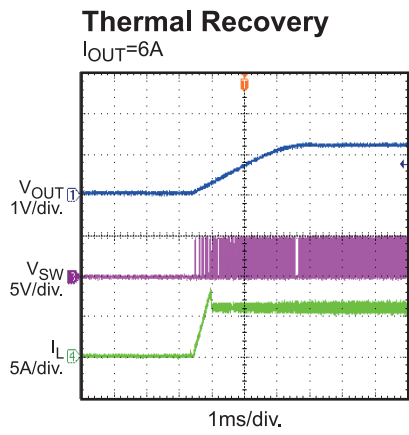

PRINTED CIRCUIT BOARD LAYOUT

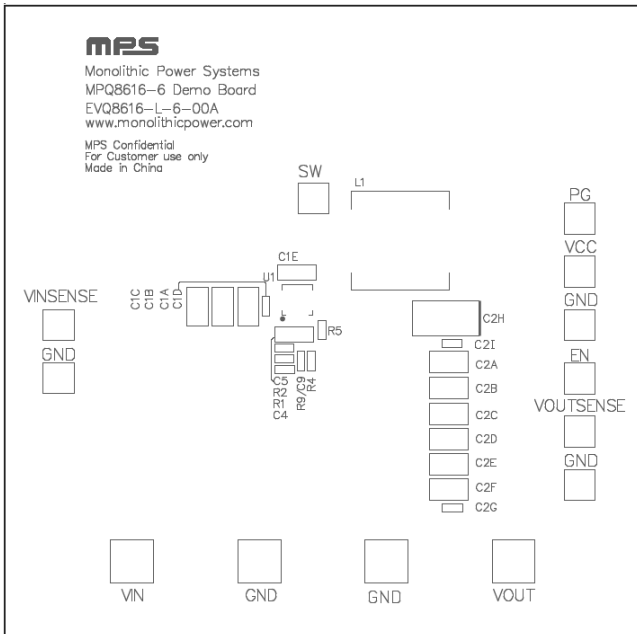

Figure 1: Top Silk Layer

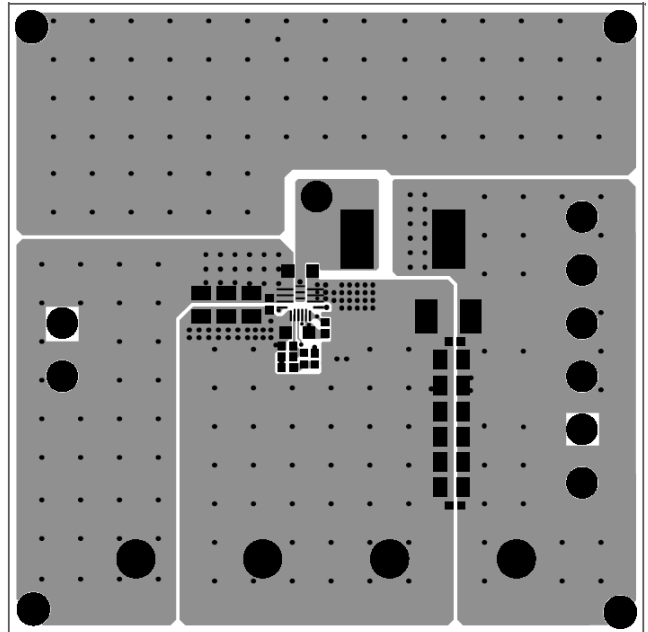

Figure 2: Top Layer

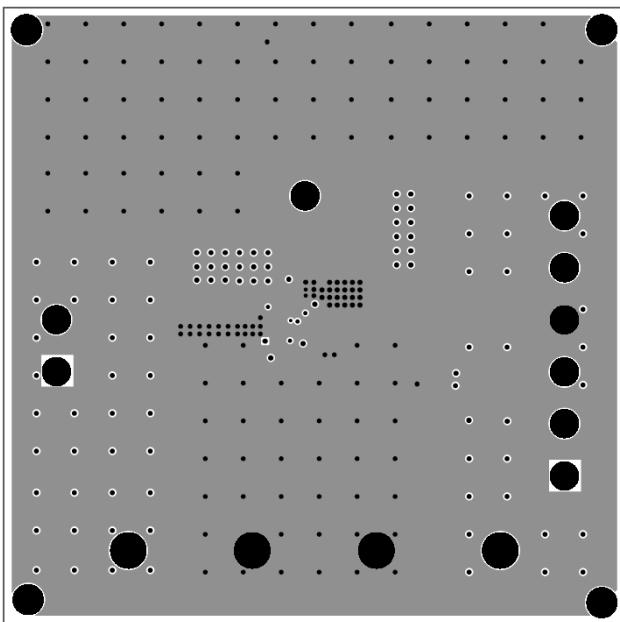

Figure 3: Inner Layer1

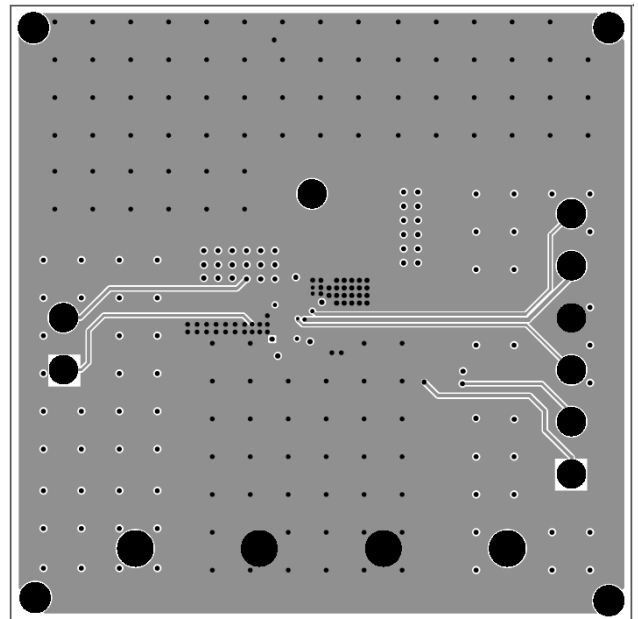

Figure 4: Inner Layer2

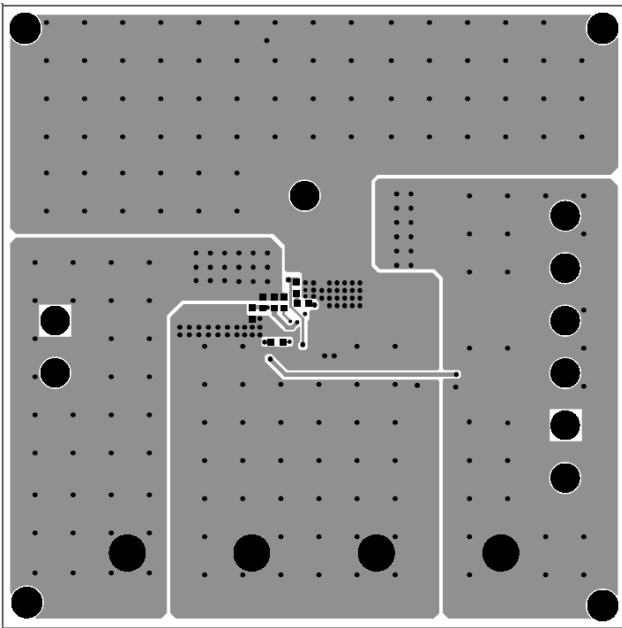

Figure 5: Bottom Layer

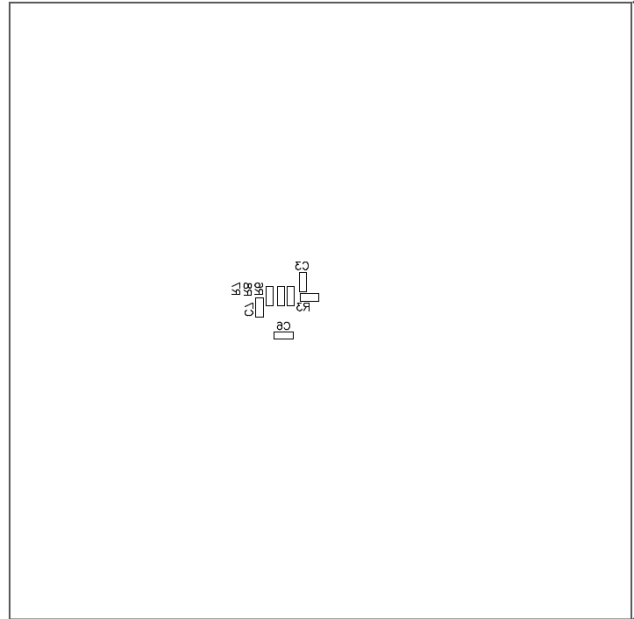

Figure 6: Bottom Silk Layer

QUICK START GUIDE

1. Connect the positive and negative terminals of the load to the VOUT and GND pins respectively. Be aware that electronic load represents negative impedance to the regulator and if set it to a too high current, the SCP protection may be triggered at startup.
2. Preset the output of power supply between 3V and 6V, and then turn off the power supply. If longer cables are used between the source and the EVB (>0.5m total), a damping capacitor should be installed at the input terminals.
3. Connect the positive and negative terminals of the power supply output to the VIN and GND pins respectively:
4. Turn the power supply on. The MPQ8616GL-6 will automatically start up.
5. To use the Enable function, apply a digital input to the EN pin. Drive EN higher than 2V to turn on the regulator or less than 0.4V to turn it off.
6. Use R1 and R2 to set the output voltage within $V_{FB}=0.6V$. Follow the Application information section in the device datasheet to select the proper value of R1, R2, inductor and output capacitor values when output voltage is changed.
7. If low ripple at light loads is needed, then use TOKO 1.2 μ H or 1.5 μ H L1. But with the larger L1, the transient response peak to peak value will become larger too.

NOTICE: The information in this document is subject to change without notice. Please contact MPS for current specifications. Users should warrant and guarantee that third party Intellectual Property rights are not infringed upon when integrating MPS products into any application. MPS will not assume any legal responsibility for any said applications.