



EVQ7920-R-00A

5V Power Management IC with 4 Buck Converters, 5 LDOs, I²C Interface, and MTP Evaluation Board

DESCRIPTION

The EVQ7920-R-00A is an evaluation board designed to demonstrate the capabilities of the MPQ7920, a power management IC (PMIC) solution with four integrated, high-efficiency, DC/DC step-down converters; five low-dropout (LDO) regulators; and a flexible I²C interface.

Constant-on-time (COT) control provides fast transient response for the step-down converters. During continuous conduction mode (CCM), the adjustable switching frequency (f_{sw}) (up to 2.75MHz) reduces the external inductance and capacitance.

The output voltage (V_{OUT}) can be adjusted via the I²C, or can be preset by the multiple-time programmable (MTP) memory.⁽¹⁾ The start-up and shutdown sequences can be configured via the MTP or the I²C.

Full protection features include under-voltage lockout (UVLO) protection, over-current protection (OCP), over-voltage protection (OVP), and thermal shutdown.

The MPQ7920 requires a minimal number of readily available, standard external components, and is available in a space-saving QFN-26 (3.5mmx4.5mm) package with wettable flanks.

Notes:

- 1) The two-time configurable MTP is only available for the standard version of the MPQ7920 (PN: MPQ7920GRM-0000-AEC1).
- 2) EN's input logic is $\leq 3.3V$.

FEATURES

- **High-Efficiency Step-Down Converters:**
 - Buck 1: 4.5A DC/DC Converter
 - Buck 2: 2.5A DC/DC Converter
 - Buck 3: 4.5A DC/DC Converter
 - Buck 4: 2A DC/DC Converter
 - Buck 1 and Buck 3 Can Operate in Parallel
 - Buck 2 and Buck 4 Can Operate in Parallel
 - 2.7V to 5.5V Input Voltage (V_{IN}) Range
 - Buck 1, Buck 2, and Buck 3 V_{OUT} :
 - 0.4V to 2.2V/7.4mV Step
 - 0.4V to 3.58V/12.5mV Step
 - Buck 4 V_{OUT} : 0.4V to 3.58V/12.5mV Step
 - Configurable f_{sw} , t_{SS} , and Phase Delay
 - Configurable Forced PWM (FPWM) Mode, Auto-PFM Mode, and Auto-PWM Mode
 - Output OCP and OVP
- **Low-Dropout (LDO) Regulators:**
 - One RTC Dedicated LDO
 - Four Low-Noise LDOs
 - Two Separate Input Power Supplies
 - 25mV Dropout Voltage at 150mA Load
- **System:**
 - I²C Interface and Configurable MTP ⁽¹⁾
 - Enable (EN) On/Off Control
 - Multi-Function Pin (LDO2/EN1) ⁽²⁾
 - Start-Up Reset Output (RSTO)
 - 0.5ms/2ms/8ms/16ms Flexible Start-Up Sequence via the MTP
 - Flexible DC/DC LDO On/Off Control via the MTP
 - ESD Ratings (All Pins): $\pm 4kV$ HBM and $\pm 2kV$ CDM

APPLICATIONS

- Automotive Infotainment Systems
- Automotive Video Recording Devices
- Automotive Display Electronics

All MPS parts are lead-free, halogen-free, and adhere to the RoHS directive. For MPS green status, please visit the MPS website under Quality Assurance. "MPS", the MPS logo, and "Simple, Easy Solutions" are trademarks of Monolithic Power Systems, Inc. or its subsidiaries.

EVQ7920-R-00A EVALUATION BOARD

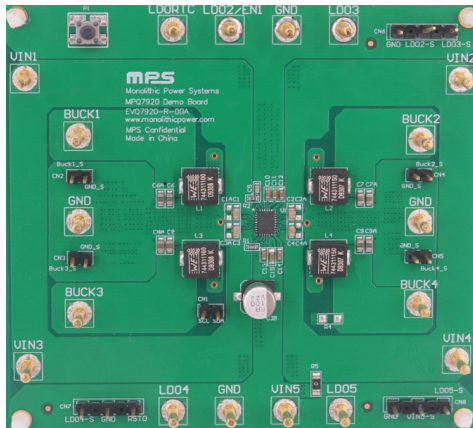

LxWxH (9.37cmx8.55cmx1.3cm)

Board Number	MPS IC Number
EVQ7920-R-00A	MPQ7920GRM-0003-AEC1

Efficiency vs. Output Current

V_{IN} = 5V; f_{sw} = 2.2MHz; buck 1, buck 2, buck 3, and buck 4 operate in PWM mode

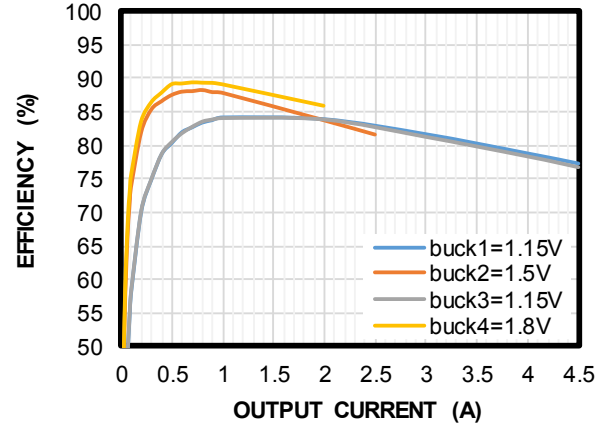



QUICK START GUIDE

1. Connect the load terminals to:
 - a. Positive (+): VOUT
 - b. Negative (-): GND
2. Preset the power supply to 5V, then turn off the power supply.
3. Connect the power supply terminals to:
 - a. Positive (+): VIN
 - b. Negative (-): GND
4. Turn on the power supply. The related parameters can be configured via the I²C. ⁽³⁾

Note:

- 3) For more information, refer to the MPQ7920 datasheet.

MTP-EFUSE SELECTED TABLE BY DEFAULT (MPQ7920GRM-0003):

MTP Items	Buck 1	Buck 2	Buck 3	Buck 4	LDO RTC	LDO 2	LDO 3	LDO 4	LDO 5
Output voltage (V _{OUT})	1.15V	1.5V	1.15V	1.8V	3.3V	1.8V	1.8V	1.1V	1.8V
Initial rail status	On	On	On	On	On	On	On	On	On
Mode	FPWM	FPWM	FPWM	FPWM	N/A				
Start-up delay	0ms	4.5ms	0ms	4.5ms	Always on	5.5ms	5.5ms	5.5ms	9.5ms
Soft-start time (t _{SS})	300μs	300μs	300μs	300μs	N/A				
Automatic start-up	Yes								
Switching frequency (f _{SW})	2.2MHz								
PWRON_MODE ⁽⁴⁾	0								
RSTO_DELAY	50ms								
Buck 1 peak current limit (I _{LIMIT_PEAK})	9.3A								
Buck 2 I _{LIMIT_PEAK}	6.1A								
Buck 3 I _{LIMIT_PEAK}	9.3A								
Buck 4 I _{LIMIT_PEAK}	6.1A								
I ² C_SLAVE_ADDRESS	0x69								
MTP configuration code	0003								

Note:

- 4) PWRON_MODE defines the trigger mode for start-up and shutdown events. If PWRON_MODE = 0, then start-up is triggered when VPWRON is high, and shutdown is triggered when VPWRON is low. If PWRON_MODE = 1, then a new start-up or shutdown event is triggered when VPWRON goes from high to low.

EVALUATION BOARD SCHEMATIC

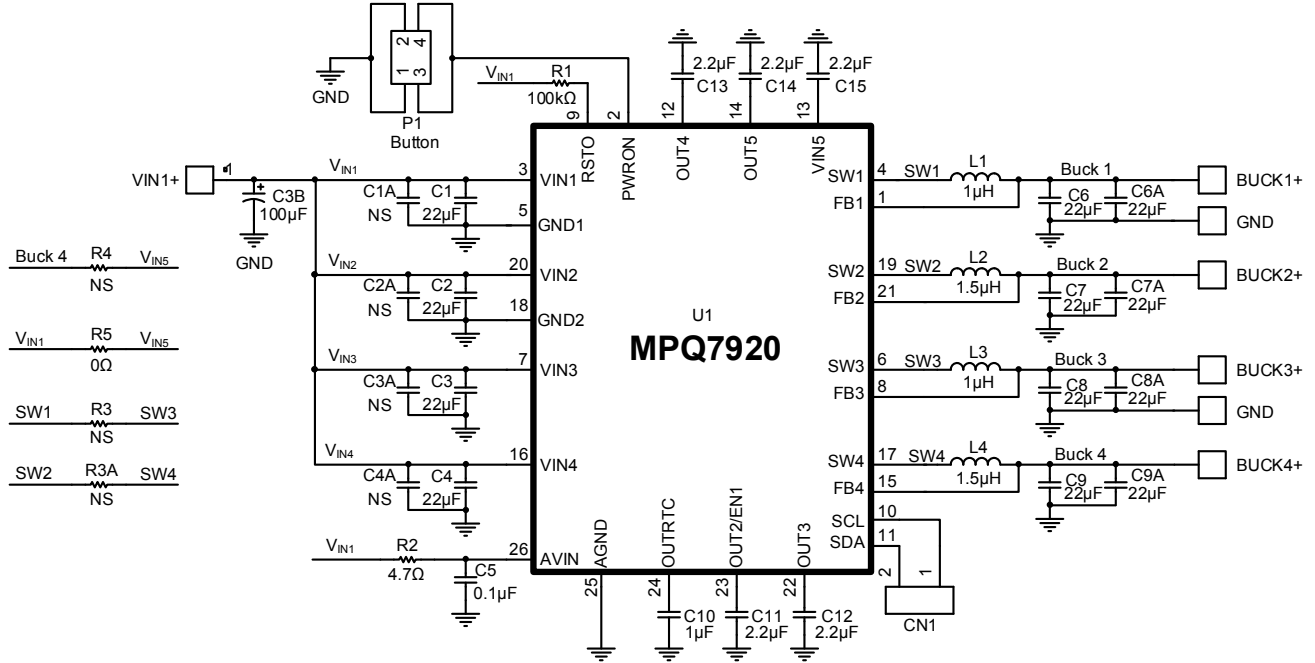

Figure 1: Evaluation Board Schematic

EVQ7920-R-00A BILL OF MATERIALS

Qty	Ref	Value	Description	Package	Manufacturer	Manufacturer PN
1	U1	MPQ7920	Power management IC, 5V	QFN-26 (3.5mmx 4.5mm)	MPS	MPQ7920GRM-0003- AEC1
4	C1, C2, C3, C4	22 μ F	Ceramic capacitor, 10V, X5R	0805	Murata	GRM21BR61A226ME51L
8	C6, C6A, C8, C8A, C7, C7A C9, C9A	22 μ F	Ceramic capacitor, 6.3V, X5R	0805	Murata	GRM21BR60J226ME39L
1	C3B	100 μ F	Electrolytic capacitor, 35V	SMD	Chemi-Con	EMZJ350ADA101MF80G
1	C10	1 μ F	Ceramic capacitor, 10V, X5R	0603	Murata	GRM188R61A105KA61D
1	C5	0.1 μ F	Ceramic capacitor, 16V, X7R	0603	Würth	885012206046
5	C11, C12, C13, C14, C15	2.2 μ F	Ceramic capacitor, 10V, X7R	0603	Murata	GRM188R71A225KE15D
1	R1	100k Ω	Film resistor, 1%	0603	Yageo	RC0603FR-07100KL
1	R2	4.7 Ω	Film resistor, 1%	0603	Yageo	RC0603FR-074R7L
1	R5	0 Ω	Film resistor, 5%	1206	Yageo	RC1206JR-070RL
2	L1, L3 (option 1)	1 μ H	Inductor, R _{DC} = 4.6m Ω , I _{SAT} = 19A	7040	Würth	744311100
	L1, L3 (option 2)	1 μ H	Inductor, R _{DC} = 5.6m Ω , I _{SAT} = 16A	7050	Superworld	PIAQ0605S1R0MN
2	L2, L4 (option 1)	1.5 μ H	Inductor, R _{DC} = 6.6m Ω , I _{SAT} = 14A	7040	Würth	744311150
	L2, L4 (option 2)	1.5 μ H	Inductor, R _{DC} = 6.6m Ω , I _{SAT} = 13A	7050	Superworld	PIAQ0605S1R5MN
1	P1	12V/0.05A	Tact switch	SMD	Würth	430181038816

EVB TEST RESULTS

Performance curves and waveforms are tested on the evaluation board with MPQ7920-0003 spec parts, $V_{IN} = 5V$, $T_A = 25^{\circ}C$, unless otherwise noted.

Steady State

All buck rails, no load

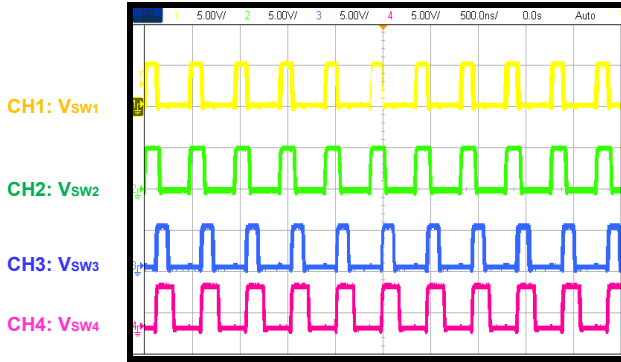

Steady State

All buck rails, full load

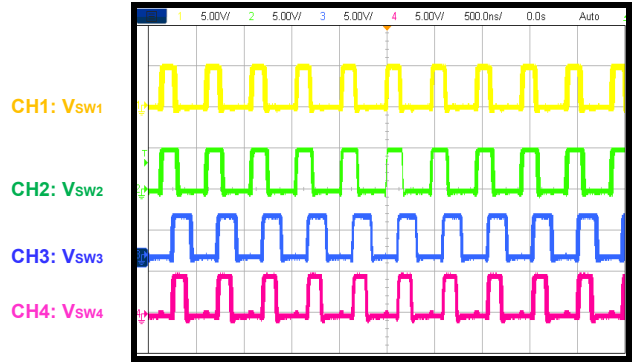

Start-Up through PWRON

All buck rails, no load

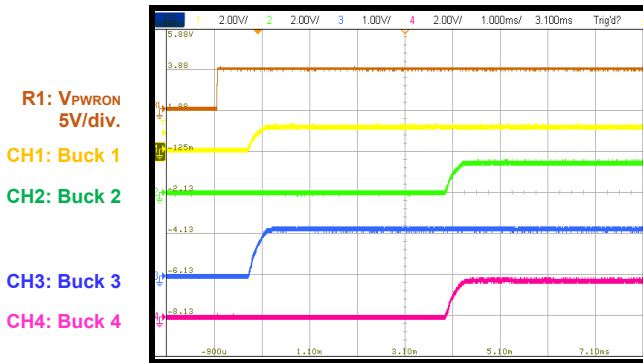

Start-Up through PWRON

All LDO rails, no load

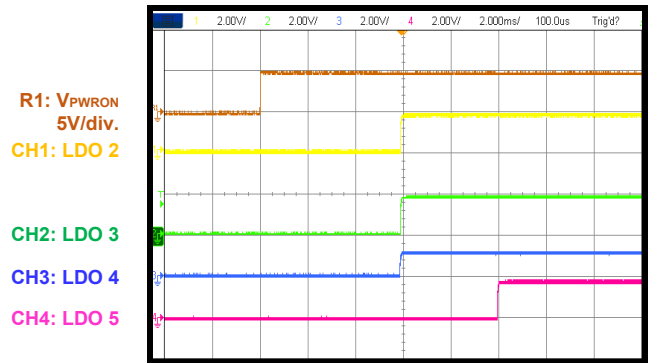

Shutdown through PWRON

All buck rails, no load

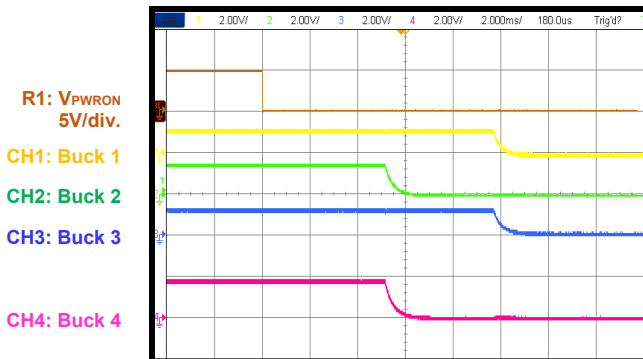

Shutdown through PWRON

All LDO rails, no load, all buck rails are disabled

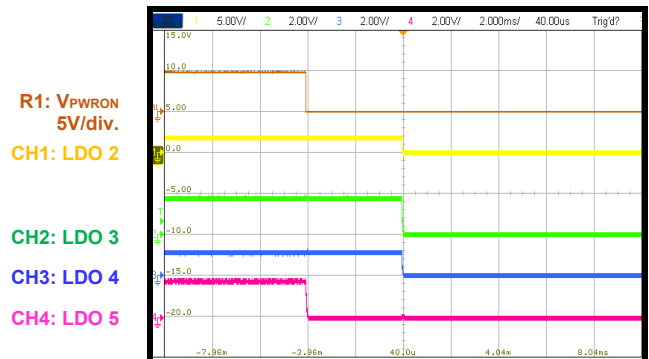

EVB TEST RESULTS (continued)

Performance curves and waveforms are tested on the evaluation board with MPQ7920-0003 spec parts, $V_{IN} = 5V$, $T_A = 25^\circ C$, unless otherwise noted.

Start-Up through VIN

All buck rails, no load

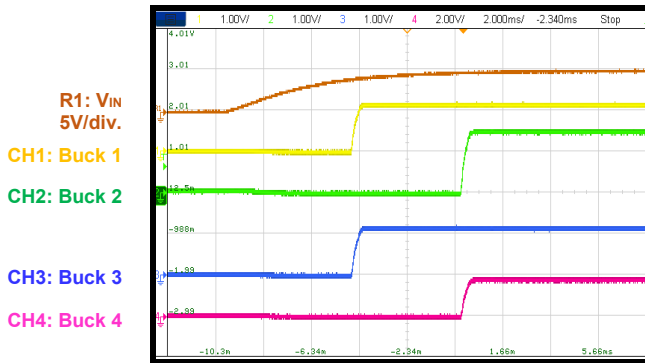

Shutdown through VIN

All buck rails, no load

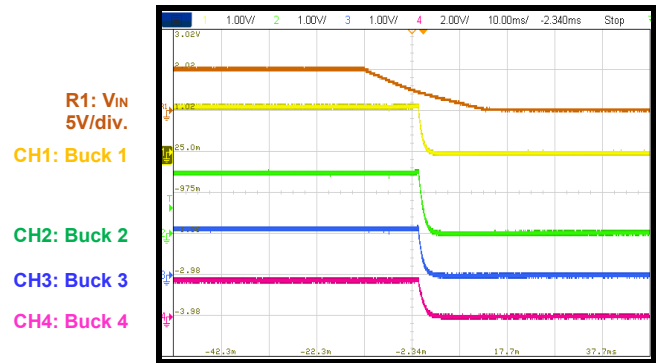

SCP Entry

Buck 4 $V_{OUT} = 1.8V$

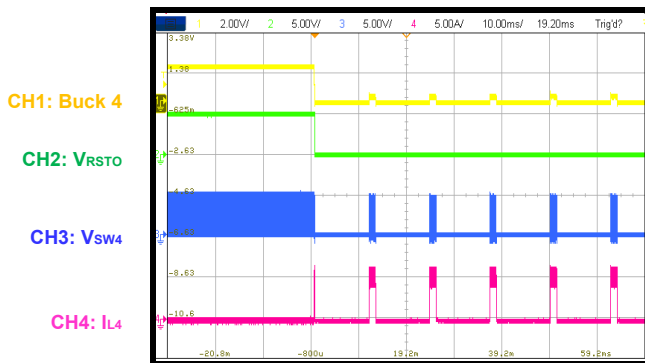

SCP Steady State

Buck 4 $V_{OUT} = 1.8V$

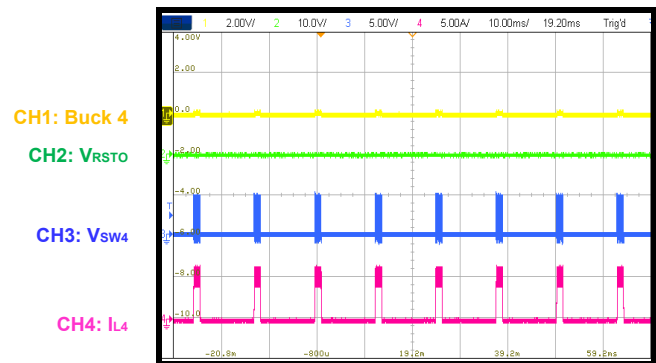

SCP Recovery

Buck 4 $V_{OUT} = 1.8V$

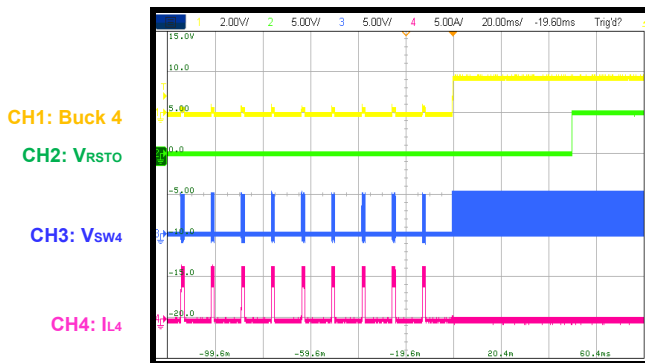

Load Transient

I_{OUT} transient from 2.25A to 4.5A,
2.5A/ μs slew rate

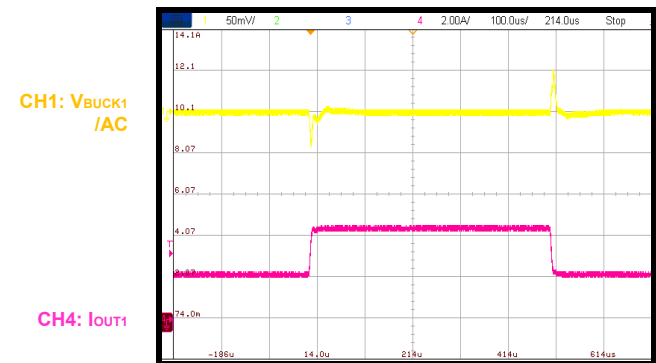

EVB TEST RESULTS (continued)

Performance curves and waveforms are tested on the evaluation board with MPQ7920-0003 spec parts, $V_{IN} = 5V$, $T_A = 25^{\circ}C$, unless otherwise noted.

Load Transient

I_{OUT} transient from 1.25A to 2.5A,
2.5A/ μs slew rate

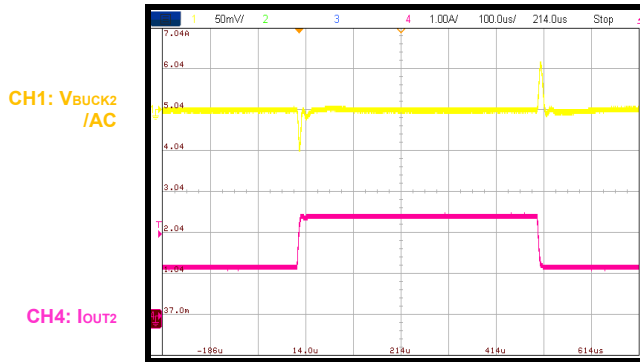

Load Transient

I_{OUT} transient from 2.25A to 4.5A,
2.5A/ μs slew rate

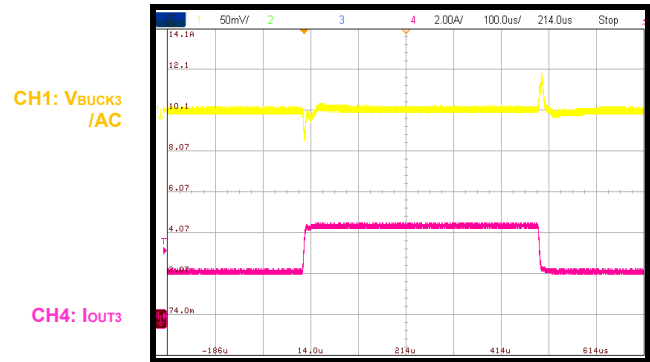

Load Transient

I_{OUT} transient from 1A to 2A, 2.5A/ μs slew rate

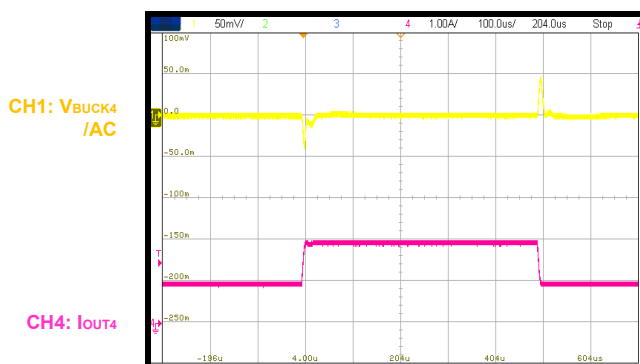

PCB LAYOUT

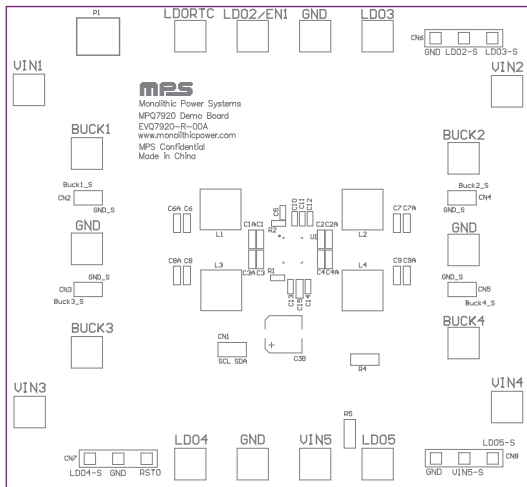

Figure 2: Top Silk

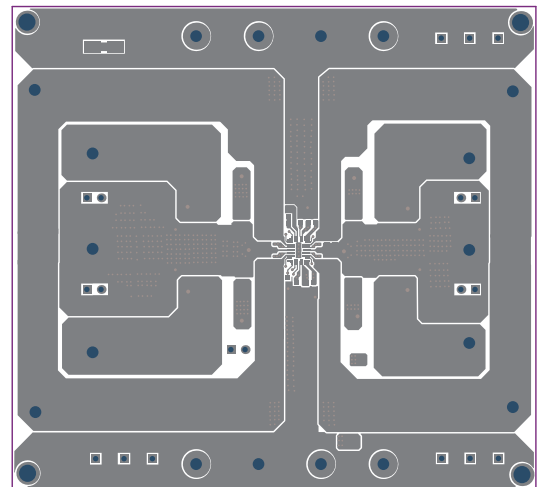

Figure 3: Top Layer

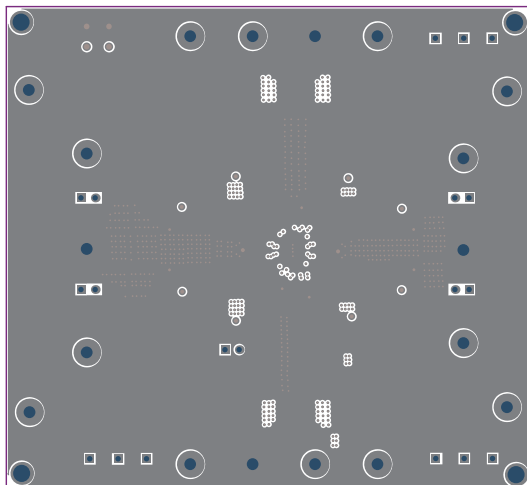

Figure 4: Mid-Layer 1

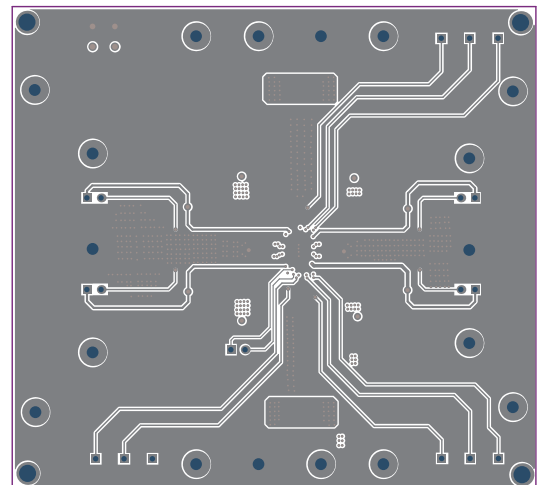

Figure 5: Mid-Layer 2

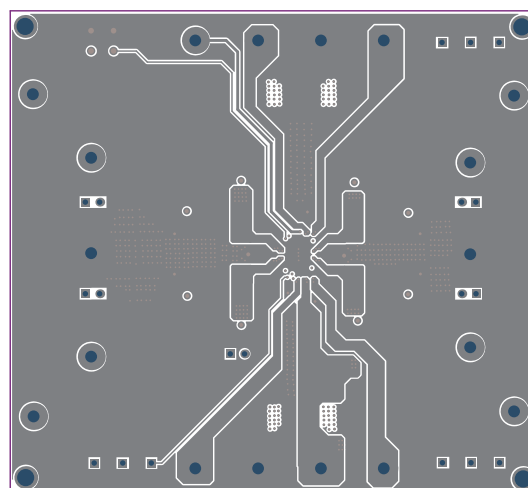

Figure 6: Bottom Layer

**REVISION HISTORY**

Revision #	Revision Date	Description	Pages Updated
1.0	10/29/2019	Initial Release	-
1.1	9/8/2021	Updated the Notes section	1
		Updated the EVQ7920-R-00A product image and the efficiency curve title in the EVQ7920-R-00A Evaluation Board section	2
		Added Note 3 and Note 4	3–4
		Updated Figure 1	5
		Updated the EVQ7920-R-00A Bill of Materials (BOM) section; added two inductor options to the BOM	6
		Updated EVB Test Results section	7–9
		Grammatical, formatting, and clerical updates; updated figure titles; updated pagination	All

Notice: The information in this document is subject to change without notice. Please contact MPS for current specifications. Users should warrant and guarantee that third-party Intellectual Property rights are not infringed upon when integrating MPS products into any application. MPS will not assume any legal responsibility for any said applications.