



EVQ7200-L-00A

42V, 3A Synchronous, Buck Mode LED Driver Evaluation Board

DESCRIPTION

The EVQ7200-L-00A is an evaluation board for the MPQ7200-AEC1, a high-frequency, constant-current LED driver with integrated power MOSFETs. It offers a compact solution to achieve 3A of continuous output current, with excellent load and line regulation over a wide input supply range.

Constant frequency hysteretic control mode provides fast transient response without loop compensation. In buck mode, the MPQ7200-AEC1's switching frequency (up to 2.3MHz) reduces ripple current and electromagnetic interference (EMI).

The MPQ7200-AEC1 is available in a QFN-19 (3mmx4mm) wettable flank package and is AEC-Q100 Grade 1 qualified.

The EVQ7200-L-00A is a fully assembled and tested buck mode LED driver evaluation board. It generates an LED current up to 3A from a 6V to 42V input range.

ELECTRICAL SPECIFICATIONS

Parameter	Symbol	Value	Units
Input voltage	V_{EMI}	6 to 42	V
Output current	I_{OUT}	3	A

FEATURES

- Wide 6V to 42V Operating Input Range
- Configurable 3A Maximum Continuous Output Current in Buck Mode
- 44mΩ/40mΩ Internal Power MOSFETs
- Default 2.3MHz Switching Frequency for Buck Mode with Spread Spectrum
- 100Hz to 2kHz Dimming Frequency for Pulse-Width Modulation (PWM) Dimming
- 500Hz Internal 2-Step Dimming with Programmable Duty Cycle
- Fault Indication for LED Short, LED Open, Output Over-Voltage, and Thermal Shutdown
- Over-Current Protection (OCP) with Latch-Off
- Programmable Thermal Derating via Negative Temperature Coefficient (NTC) Remote Temperature Sensing
- EMI Reduction Technique
- Available in a QFN-19 (3mmx4mm) Wettable Flank Package
- Available in AEC-Q100 Grade 1

APPLICATIONS

- Automotive LED Lighting

All MPS parts are lead-free, halogen-free, and adhere to the RoHS directive. For MPS green status, please visit the MPS website under Quality Assurance. "MPS", the MPS logo, and "Simple, Easy Solutions" are trademarks of Monolithic Power Systems, Inc. or its subsidiaries.

EVQ7200-L-00A EVALUATION BOARD



LxWxH (9cmx9cmx1.3cm)

Board Number	MPS IC Number
EVQ7200-L-00A	MPQ7200GLE-AEC1

Efficiency vs input voltage

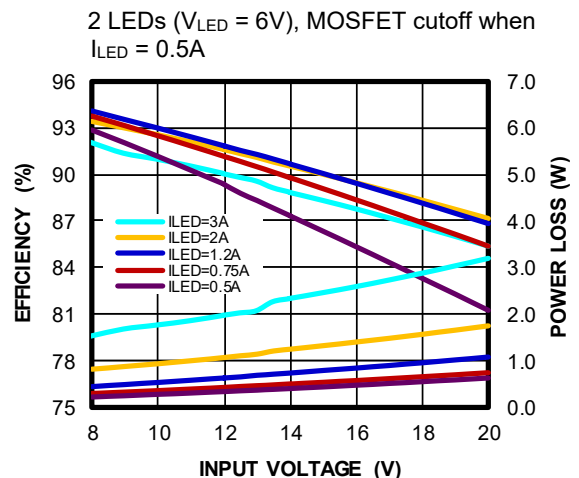

QUICK START GUIDE

1. Preset the power supply between 6V and 42V, then turn off the power supply.
2. If longer cables (>0.5m total) are being used between the source and the evaluation board, install a damping capacitor at the input terminals. This is critical when V_{EMI} exceeds 24V.
3. Connect the power supply terminals to:
 - a. Positive (+): VEMI
 - b. Negative (-): GND
4. Connect the load terminals to:
 - a. Positive (+): VLED+
 - b. Negative (-): VLED-
5. After making the connections, turn on the power supply.
6. To use the enable (EN) function, apply a digital input to the EN/DIM pin. Drive EN above 2.5V to turn on the regulator on; drive EN below 1V to turn it off.
7. When 2-step dimming is off ($R_{DUTY} = 4.87k\Omega$), an external 100Hz to 2kHz pulse-width modulation (PWM) waveform can be applied to the EN/DIM pin.
8. Use the EN/DIM pin to start the 2-step dimming function. When EN/DIM is high, the dimming duty cycle is 100%. When EN/DIM is low, the dimming duty cycle percentage varies (see Table 1).

Table 1 shows the proposed resistor (R3) in E96 series for different dimming duty cycles.

Table 1: 2-Step Dimming Duty vs. R3

2-Step Dimming Duty	R3 (Ω)
15%	61900
14%	41200
13%	27400
12%	18200
11%	12100
10%	7870
2-step dimming off	4870
9%	3090
8%	2050
7%	1370
6%	887
5%	576

9. Set the LED current with the external resistor connected to the ISET pin. The value of the external resistor can be calculated with Equation (1):

$$R5 = \frac{16}{I_{LED}(A)} (k\Omega) \quad (1)$$

EVALUATION BOARD SCHEMATIC

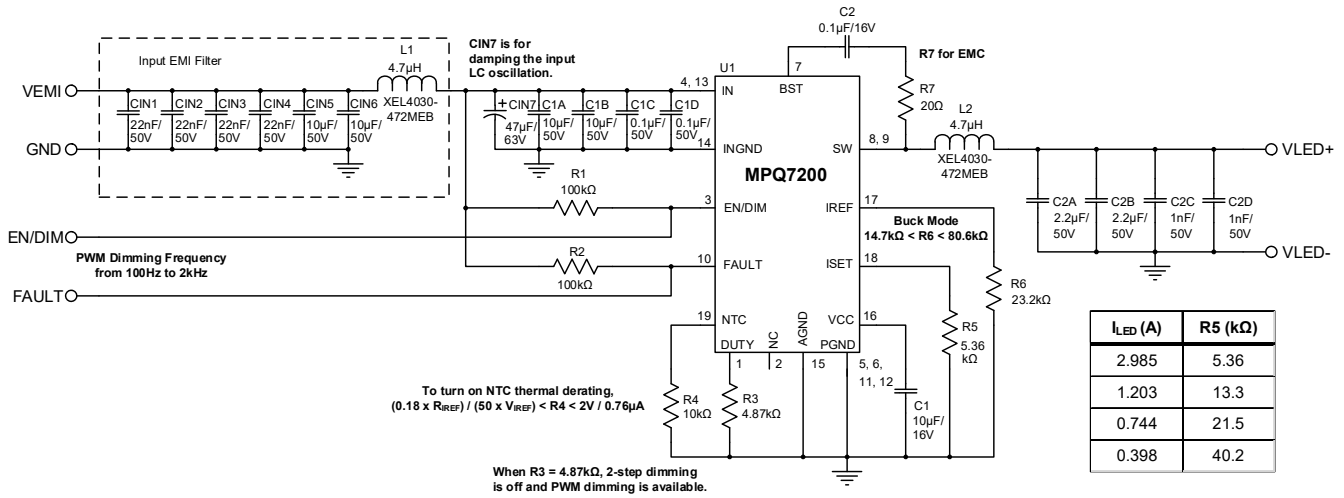
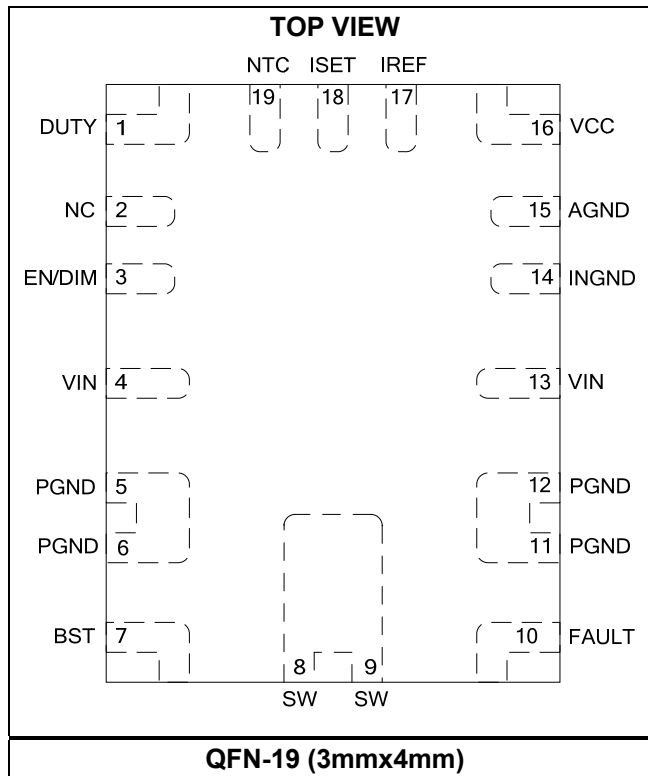

Figure 1: Evaluation Board Schematic

PACKAGE REFERENCE



EVQ7200-L-00A BILL OF MATERIALS

Qty	Ref	Value	Description	Package	Manufacturer	Manufacturer PN
4	C1A, C1B, CIN5, CIN6	10 μ F	Ceramic capacitor, 50V, X7R	1210	Murata	GRM32ER71H106KA8
2	C1C, C1D	0.1 μ F	Ceramic capacitor, 50V, X7R	0603	Murata	GRM188R71H104KA93D
2	C2A, C2B	2.2 μ F	Ceramic capacitor, 50V, X7R	1210	TDK	C3225X7R1H225K
2	C2C, C2D	1nF	Ceramic capacitor, 50V, C0G	0603	Murata	GRM1885C1H02JAC
1	C1	10 μ F	Ceramic capacitor, 16V, X5R	0603	Murata	GRM188R61C106KAA
1	C2	0.1 μ F	Ceramic capacitor, 16V, X7R	0603	Murata	GRM188R71C104KA01D
1	CIN7	47 μ F	Electrolytic capacitor, 63V	SMD	Panasonic	EEHZC1J470P
4	CIN1, CIN2, CIN3, CIN4	22nF	Ceramic capacitor, 50V, X7R	0603	TDK	C1608X7R1H223K
1	L1, L2	4.7 μ H	Inductor, 44.1m Ω DCR, 5.1A	SMD	Coilcraft	XEL4030-472MEB
2	R1, R2	100k Ω	Film resistor, 5%	0603	Yageo	RC0603JR-07100KL
1	R3	4.87k Ω	Film resistor, 1%	0603	Yageo	RC0603FR-074K87L
2	R4	10k Ω	Film resistor, 1%	0603	Yageo	RC0603FR-0710KL
1	R5	5.36k Ω	Film resistor, 1%	0603	Yageo	RC0603FR-075K36L
1	R6	23.2k Ω	Film resistor, 1%	0603	Yageo	RC0603FR-0723K2L
1	R7	20 Ω	Film resistor, 1%	0603	Yageo	RC0603FR-0720RL
1	U1		Step-up/down LED driver	QFN-19 (3mmx4mm)	MPS	MPQ7200GLE-AEC1
5	VEMI, GND, VLED+, VLED-		2 golden pin		Custom ⁽¹⁾	
3	EN/DIM, GND, FAULT		1 golden pin		Custom ⁽¹⁾	

Note:

1) MPS custom-produces these pins. Visit the Contact page on our website for more information.

EVB TEST RESULTS

Performance curves and waveforms are tested on the evaluation board. $V_{IN} = 13.5V$, $V_{LED} = 6V$, $L = 4.7\mu H$, $f_{SW} = 2.3MHz$, $T_A = 25^\circ C$, in buck mode, unless otherwise noted.

CISPR25 Class 5 Peak Conducted Emissions

150kHz to 108MHz

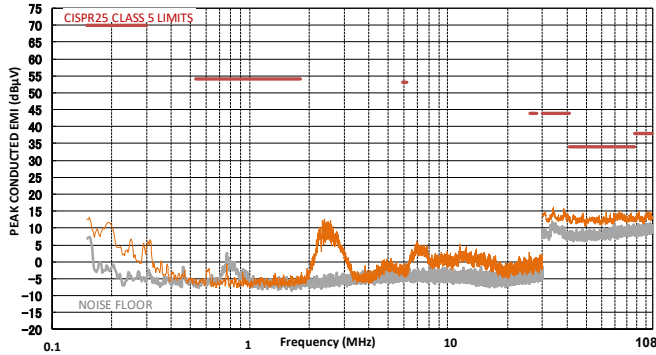

CISPR25 Class 5 Average Conducted Emissions

150kHz to 108MHz

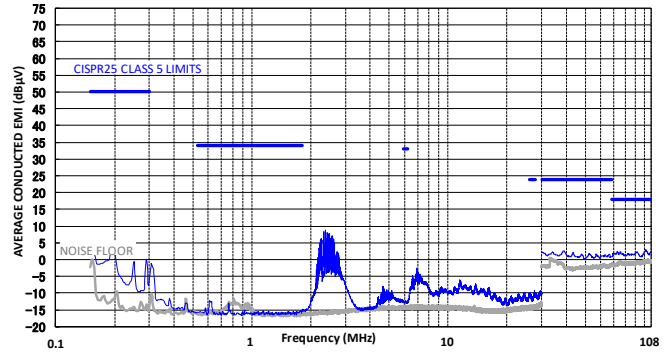

CISPR25 Class 5 Peak Radiated Emissions

150kHz to 30MHz

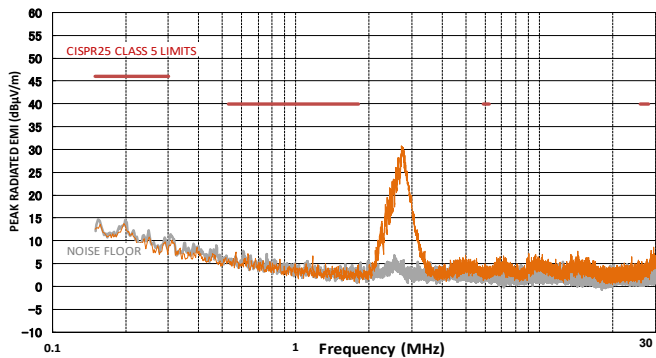

CISPR25 Class 5 Average Radiated Emissions

150kHz to 30MHz

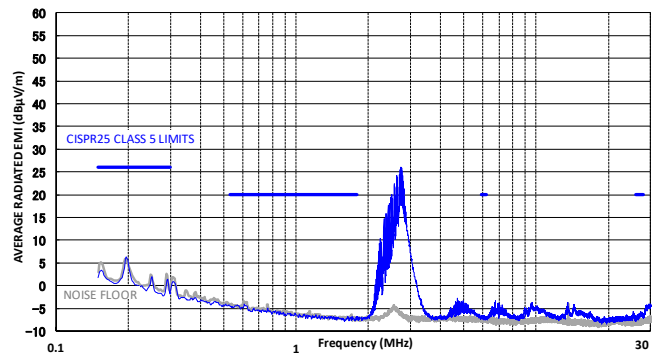

CISPR25 Class 5 Peak Radiated Emissions

Horizontal, 30MHz to 200MHz

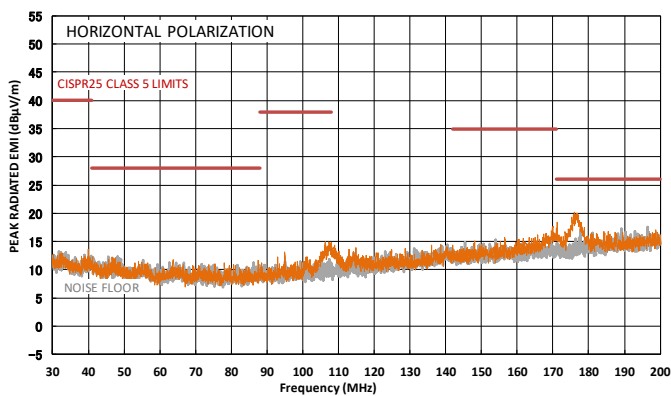

CISPR25 Class 5 Average Radiated Emissions

Horizontal, 30MHz to 200MHz

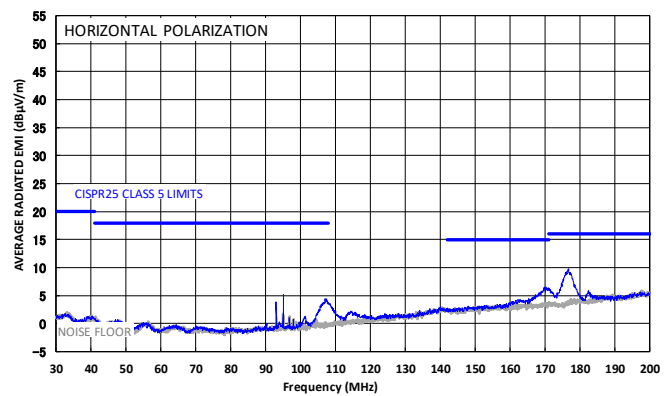

EVB TEST RESULTS *(continued)*

Performance curves and waveforms are tested on the evaluation board. $V_{IN} = 13.5V$, $V_{LED} = 6V$, $L = 4.7\mu H$, $f_{SW} = 2.3MHz$, $T_A = 25^\circ C$, in buck mode, unless otherwise noted.

CISPR25 Class 5 Peak Radiated Emissions

Vertical, 30MHz to 200MHz

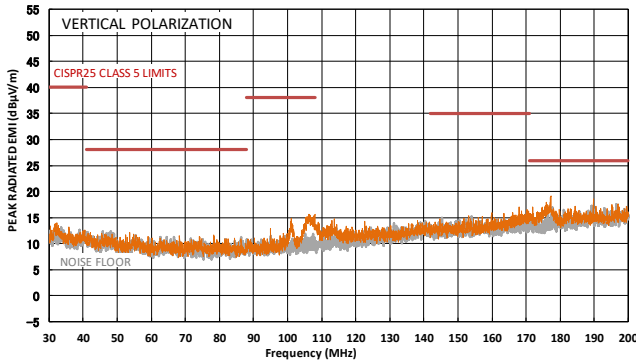

CISPR25 Class 5 Average Radiated Emissions

Vertical, 30MHz to 200MHz

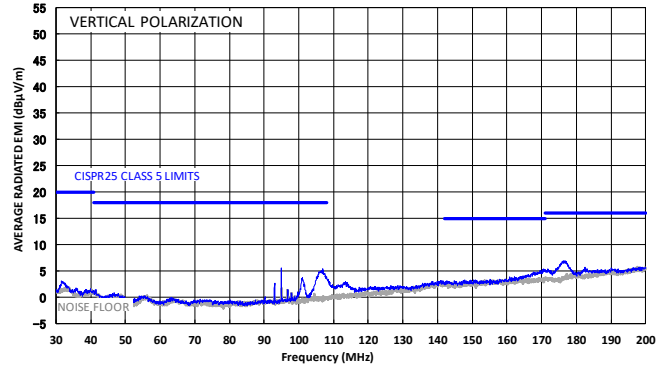

CISPR25 Class 5 Peak Radiated Emissions

Horizontal, 200MHz to 1GHz

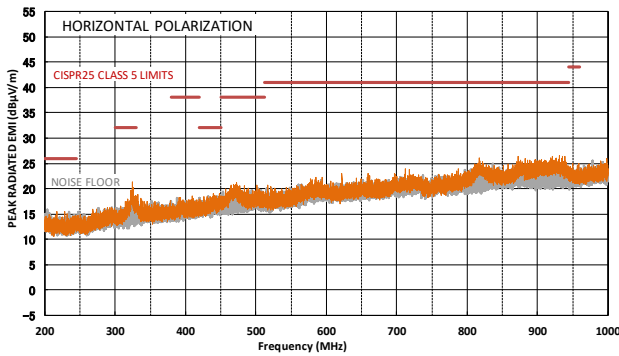

CISPR25 Class 5 Average Radiated Emissions

Horizontal, 200MHz to 1GHz

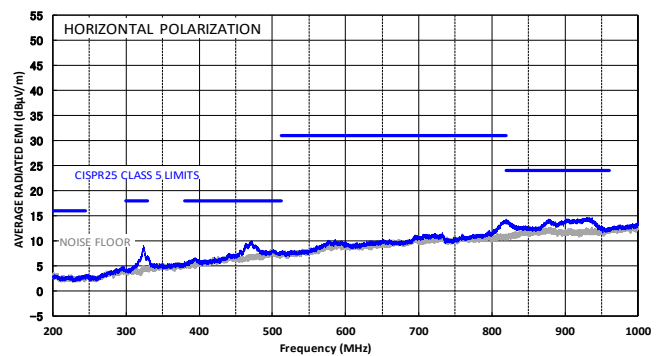

CISPR25 Class 5 Peak Radiated Emissions

Vertical, 200MHz to 1GHz

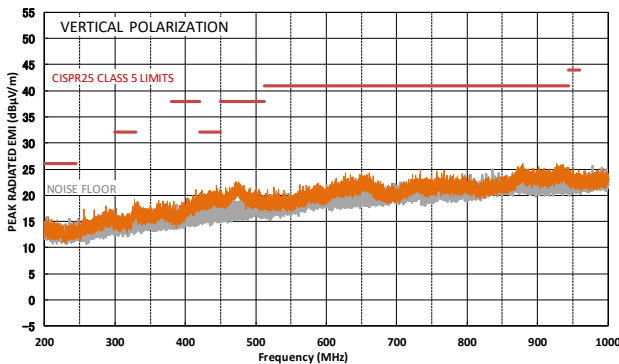

CISPR25 Class 5 Average Radiated Emissions

Vertical, 200MHz to 1GHz

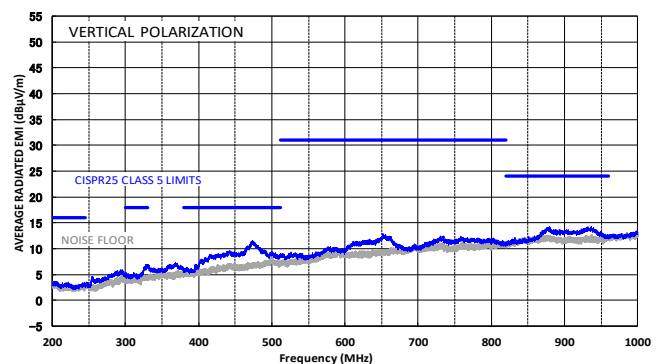

EVB TEST RESULTS (continued)

Performance curves and waveforms are tested on the evaluation board. $V_{IN} = 13.5V$, $V_{LED} = 6V$, $L = 4.7\mu H$, $f_{SW} = 2.3MHz$, $T_A = 25^\circ C$, in buck mode, unless otherwise noted.

Efficiency vs. Input Voltage

2 LEDs ($V_{LED} = 6V$), MOSFET cutoff when $I_{LED} = 0.5A$

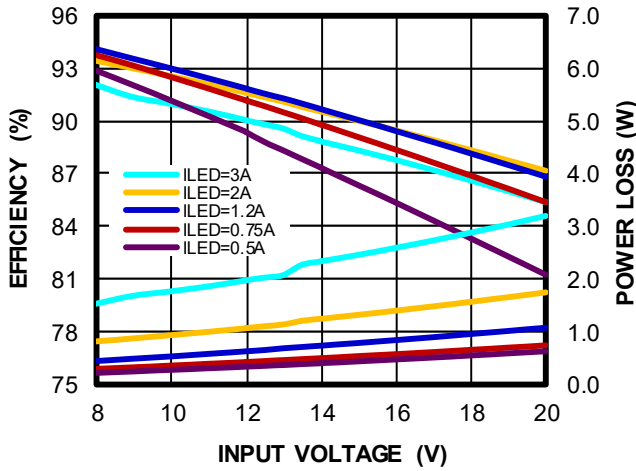

Efficiency vs. Input Voltage

1 LED ($V_{LED} = 3V$), MOSFET cutoff when $I_{LED} = 0.5A$

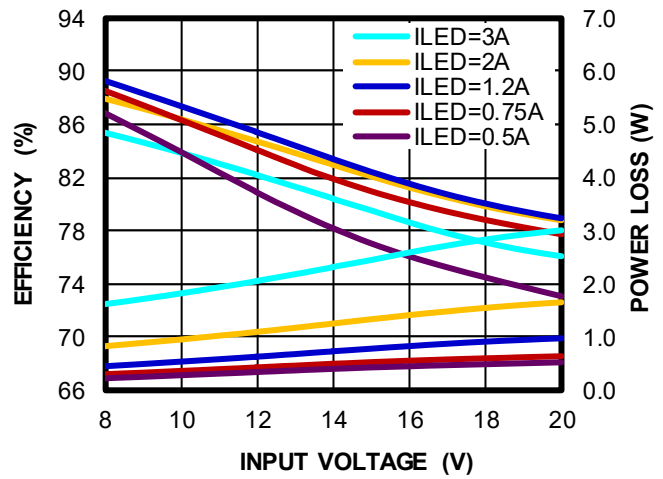

Case Temperature Rise vs. Input Voltage

2 LEDs ($V_{LED} = 6V$)

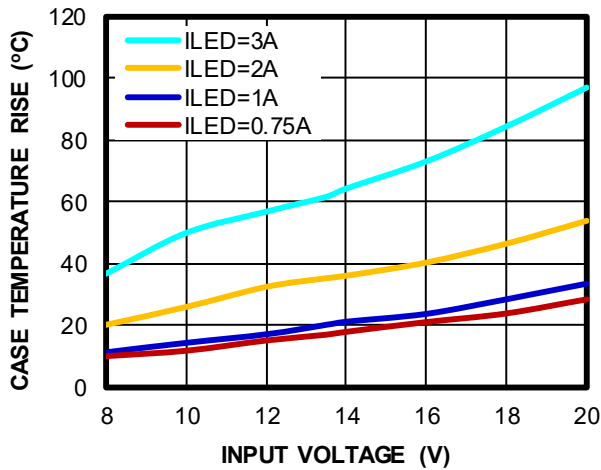

Case Temperature Rise vs. Input Voltage

1 LED ($V_{LED} = 3V$)

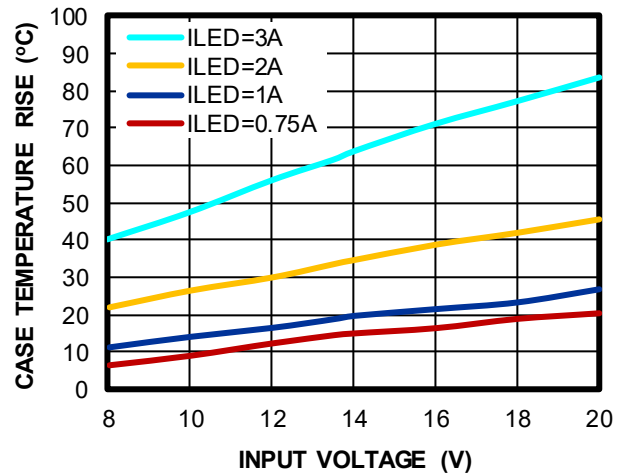

EVB TEST RESULTS (continued)

Performance curves and waveforms are tested on the evaluation board. $V_{IN} = 13.5V$, $V_{LED} = 6V$, $L = 4.7\mu H$, $f_{sw} = 2.3MHz$, $T_A = 25^\circ C$, in buck mode, unless otherwise noted.

Steady State

$I_{LED} = 3A$

CH2: $V_{LED+} - V_{LED-}$
5V/div.
CH3: I_{LED}
1A/div.
CH4: I_L
1A/div.
CH1: V_{sw}
5V/div.

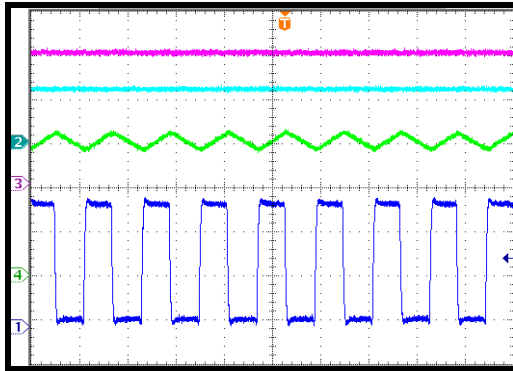

400ns/div.

Start-Up through VIN

$I_{LED} = 3A$

V_{IN}
10V/div.
CH2: $V_{LED+} - V_{LED-}$
5V/div.
CH3: I_{LED}
2A/div.
CH4: I_L
2A/div.
CH1: V_{sw}
5V/div.

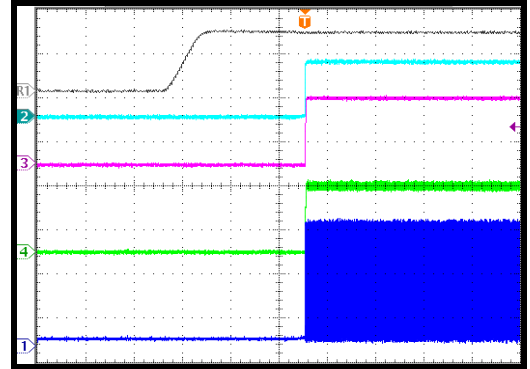

2ms/div.

Shutdown through VIN

$I_{LED} = 3A$

V_{IN}
10V/div.
CH2: $V_{LED+} - V_{LED-}$
10V/div.
CH3: I_{LED}
2A/div.
CH4: I_L
2A/div.
CH1: V_{sw}
5V/div.

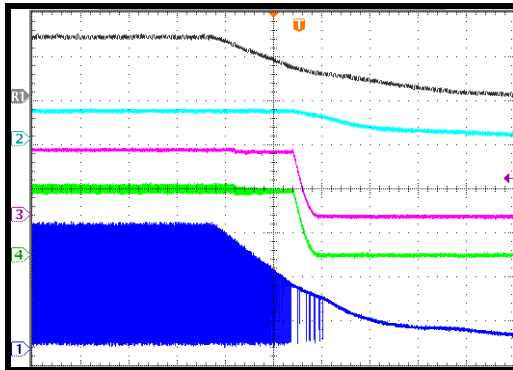

4ms/div.

Start-Up through EN

$I_{LED} = 3A$

V_{EN}
2V/div.
CH2: $V_{LED+} - V_{LED-}$
5V/div.
CH3: I_{LED}
2A/div.
CH4: I_L
2A/div.
CH1: V_{sw}
5V/div.

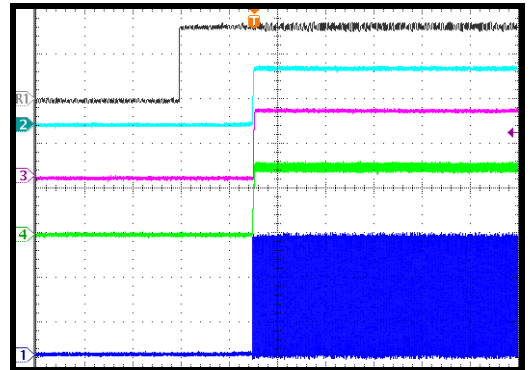

1ms/div.

Shutdown through EN

$I_{LED} = 3A$

V_{EN}
2V/div.
CH2: $V_{LED+} - V_{LED-}$
5V/div.
CH3: I_{LED}
2A/div.
CH4: I_L
2A/div.
CH1: V_{sw}
5V/div.

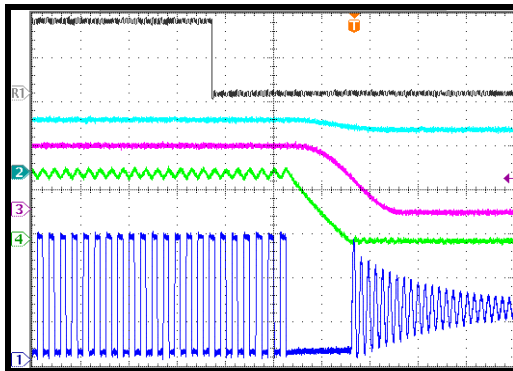

2μs/div.

PWM Dimming Steady State

Dimming frequency = 100Hz

V_{FAULT}
10V/div.
CH2: $V_{LED+} - V_{LED-}$
5V/div.
CH3: I_{LED}
2A/div.
CH4: I_L
2A/div.
CH1: V_{sw}
5V/div.

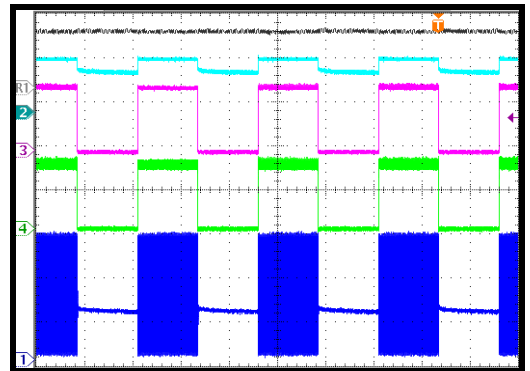

4ms/div.

EVB TEST RESULTS (continued)

Performance curves and waveforms are tested on the evaluation board. $V_{IN} = 13.5V$, $V_{LED} = 6V$, $L = 4.7\mu H$, $f_{sw} = 2.3MHz$, $T_A = 25^\circ C$, in buck mode, unless otherwise noted.

PWM Dimming Steady State
Dimming frequency = 500Hz

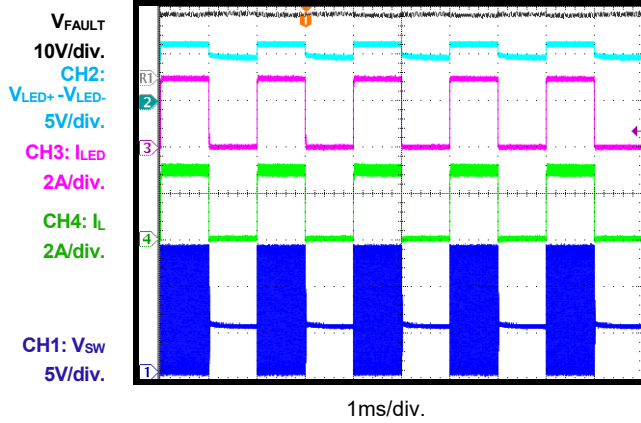

PWM Dimming
Start-up through VIN

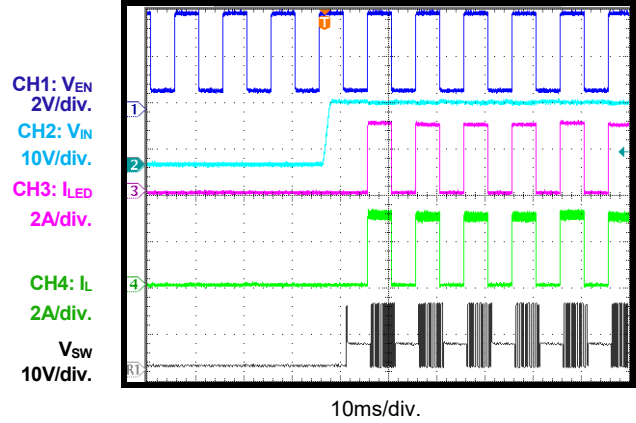

PWM Dimming
Shutdown through VIN

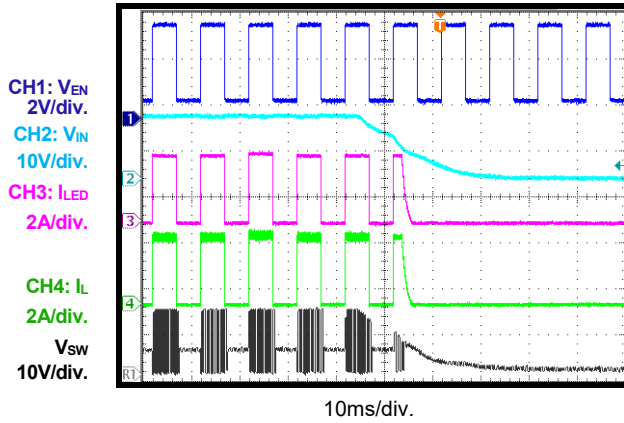

2-Step Dimming
Steady state

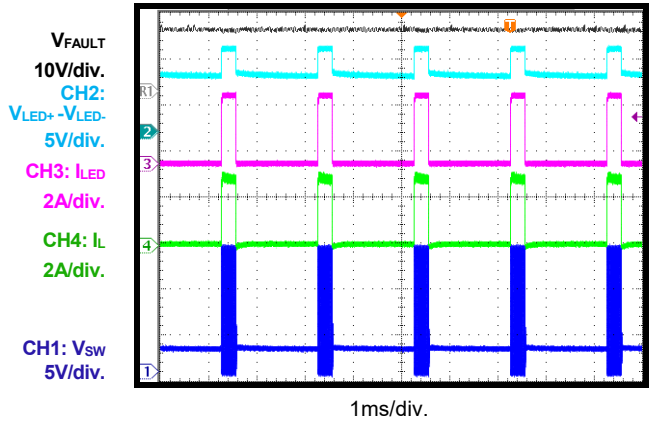

2-Step Dimming
Start-up through VIN

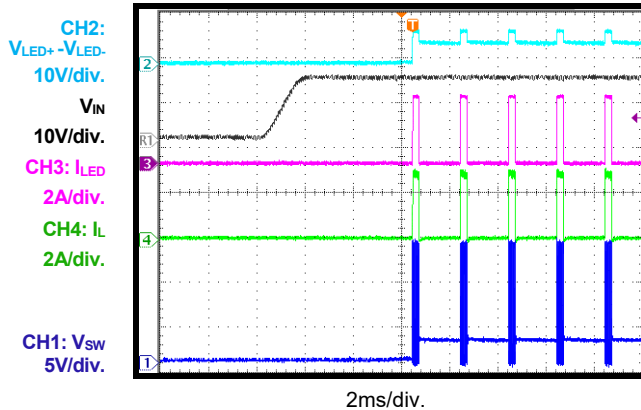

2-Step Dimming
Shutdown through VIN

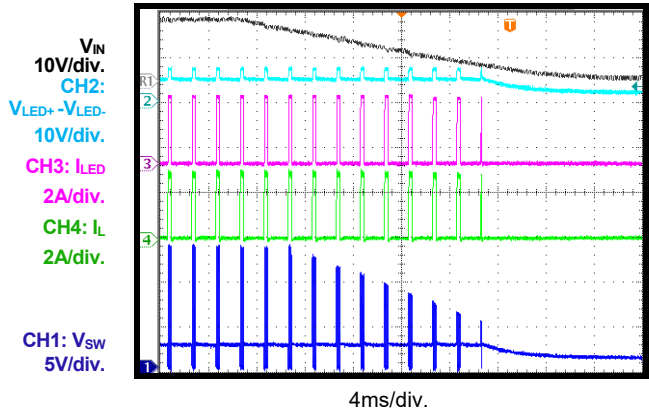

EVB TEST RESULTS (continued)

Performance curves and waveforms are tested on the evaluation board. $V_{IN} = 13.5V$, $V_{LED} = 6V$, $L = 4.7\mu H$, $f_{sw} = 2.3MHz$, $T_A = 25^\circ C$, in buck mode, unless otherwise noted.

No Dimming
LED open power on

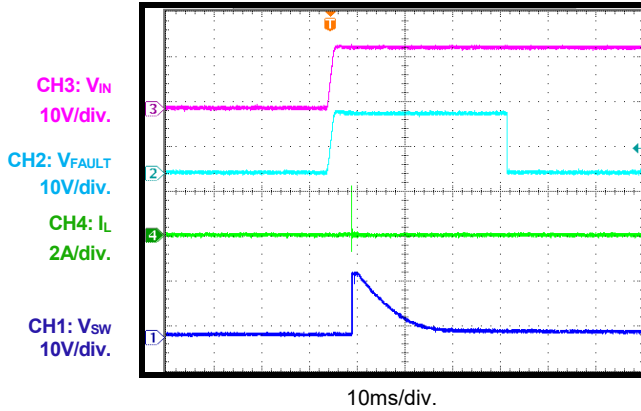

No Dimming
LED open entry

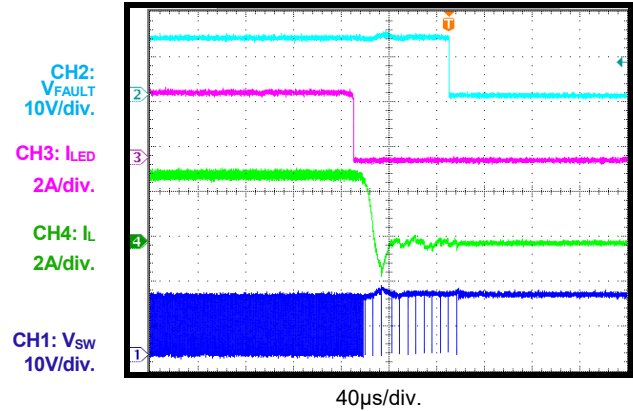

PWM Dimming
LED open power on

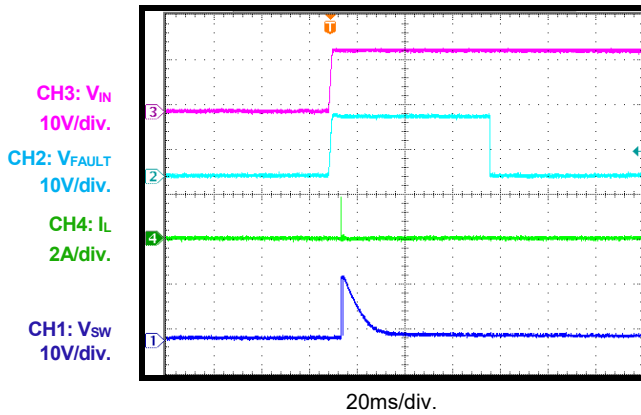

PWM Dimming
LED open entry

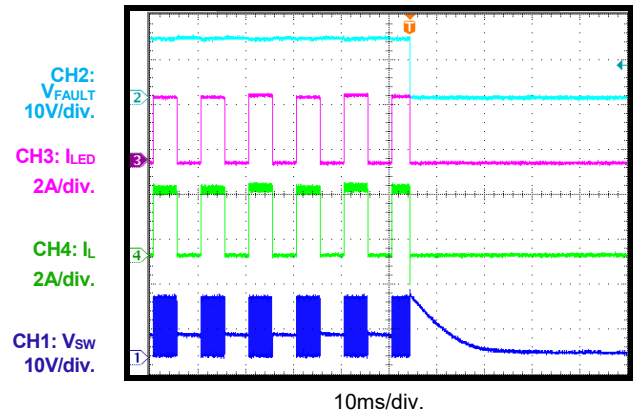

2-Step Dimming
LED open power on

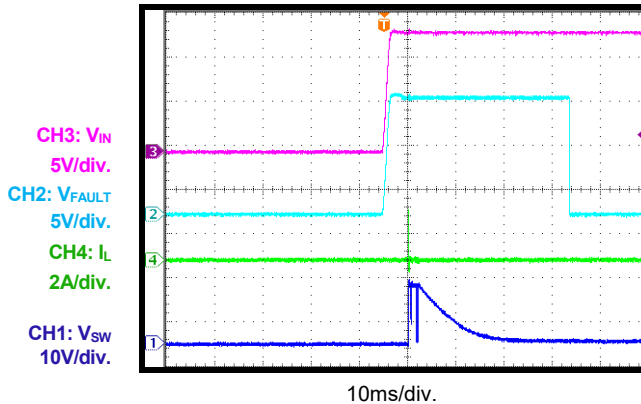

2-Step Dimming
LED open entry

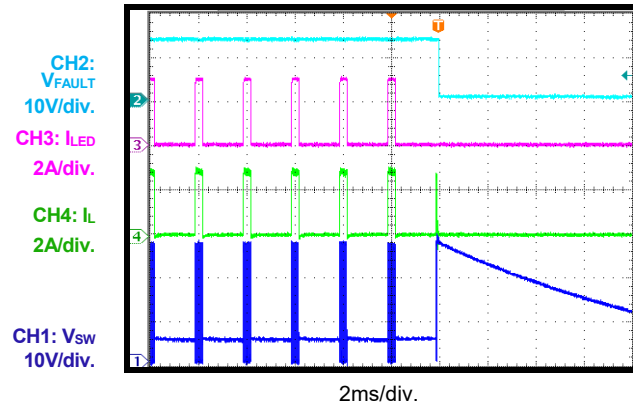

EVB TEST RESULTS (continued)

Performance curves and waveforms are tested on the evaluation board. $V_{IN} = 13.5V$, $V_{LED} = 6V$, $L = 4.7\mu H$, $f_{sw} = 2.3MHz$, $T_A = 25^\circ C$, in buck mode, unless otherwise noted.

No Dimming

LED+ short to LED- power on

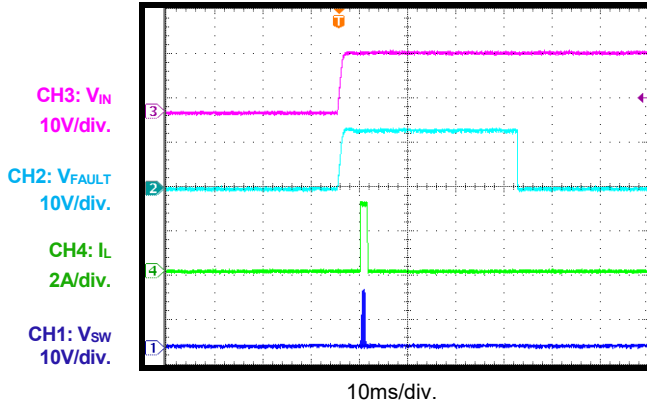

No Dimming

LED+ short to LED- entry

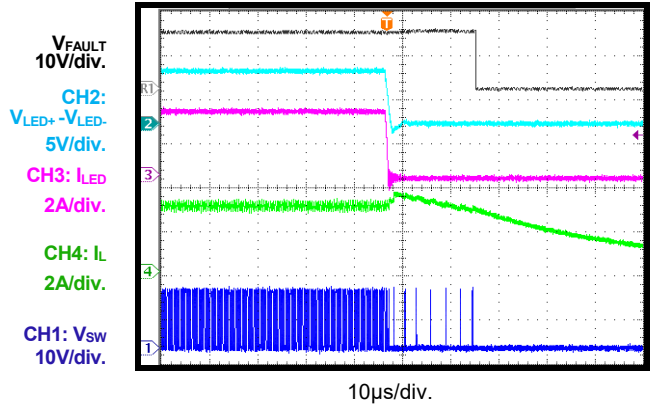

PWM Dimming

LED+ short to LED- power on

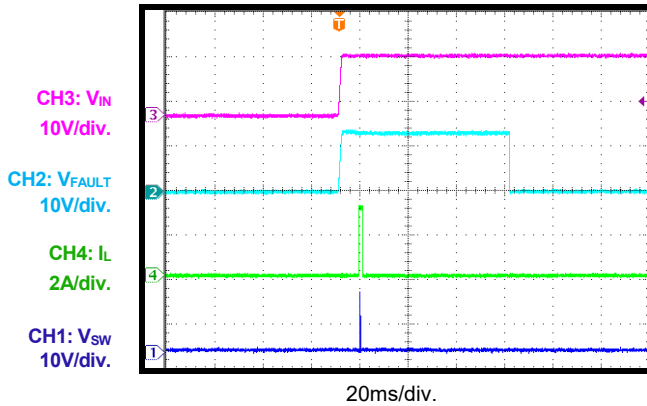

PWM Dimming

LED+ short to LED- entry

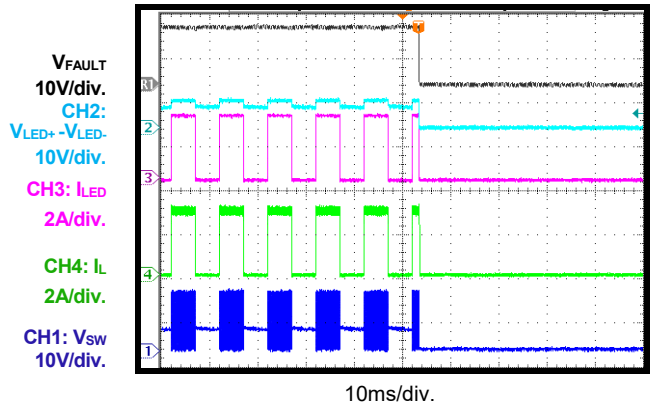

2-Step Dimming

LED+ short to LED- power on

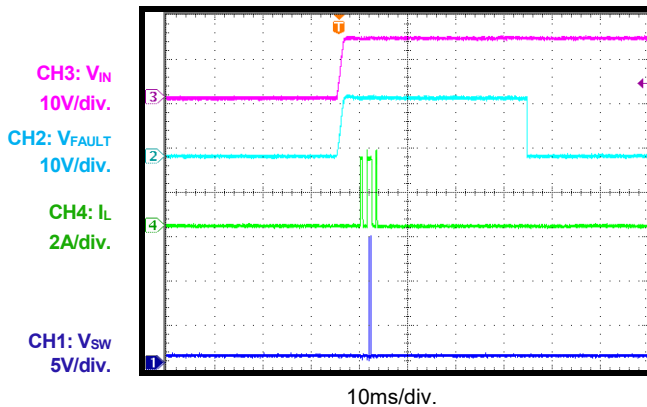

2-Step Dimming

LED+ short to LED- entry

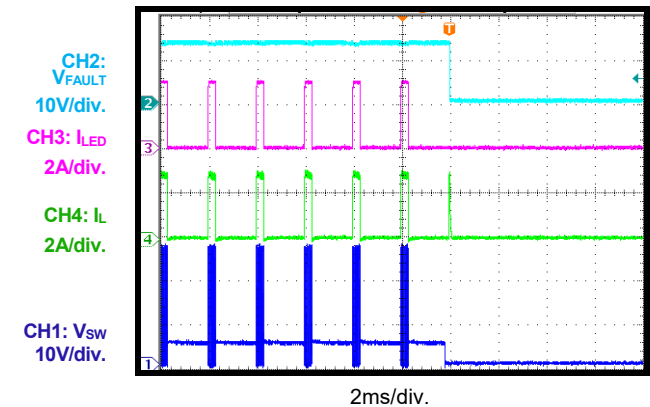

EVB TEST RESULTS (continued)

Performance curves and waveforms are tested on the evaluation board. $V_{IN} = 13.5V$, $V_{LED} = 6V$, $L = 4.7\mu H$, $f_{SW} = 2.3MHz$, $T_A = 25^\circ C$, in buck mode, unless otherwise noted.

IREF Short before Start-Up

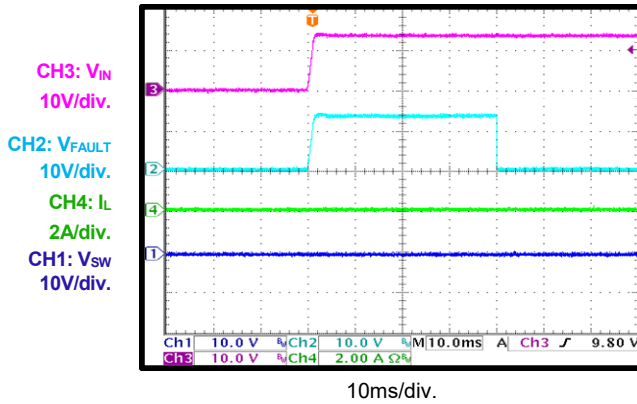

IREF Open before Start-Up

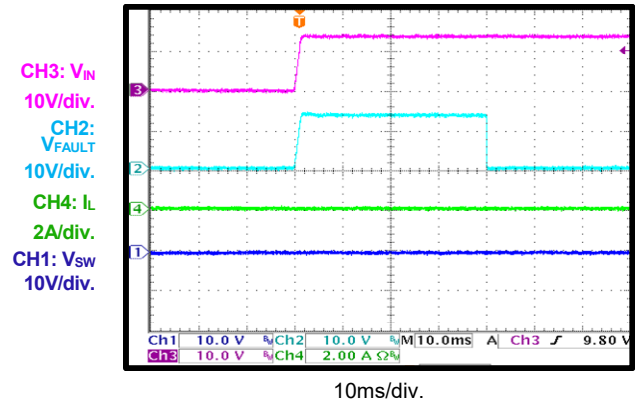

IREF Short after Start-Up

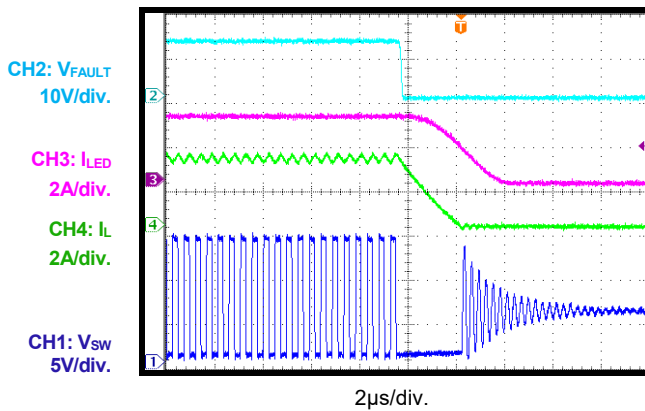

IREF Open after Start-Up

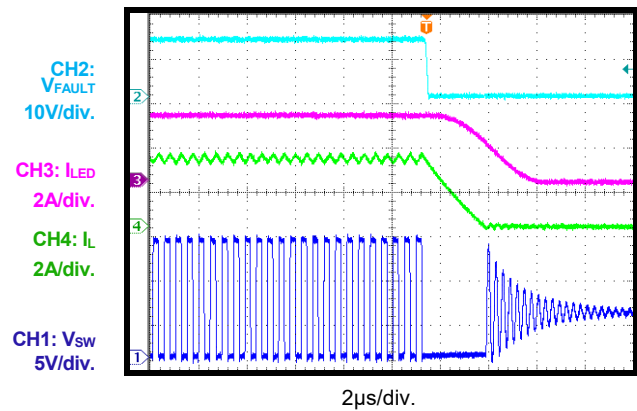

IREF Short after Start-Up

PWM dimming

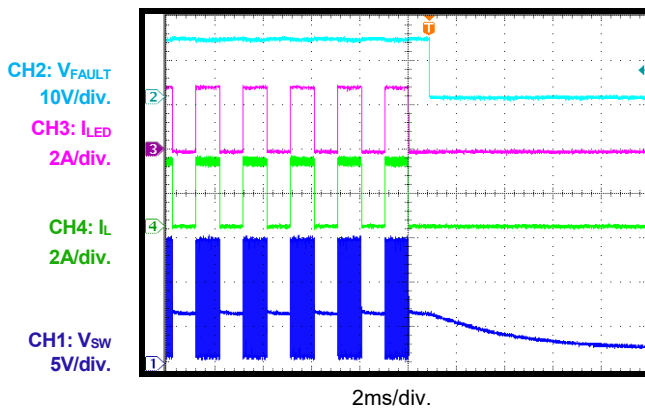

IREF Open after Start-Up

PWM dimming

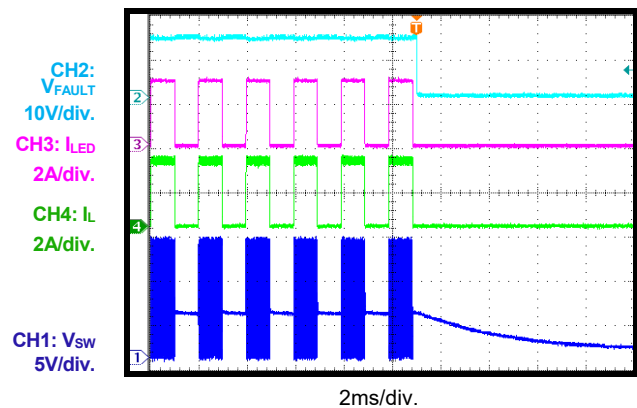

EVB TEST RESULTS (continued)

Performance curves and waveforms are tested on the evaluation board. $V_{IN} = 13.5V$, $V_{LED} = 6V$, $L = 4.7\mu H$, $f_{sw} = 2.3MHz$, $T_A = 25^\circ C$, in buck mode, unless otherwise noted.

ISET Short before Start-Up
PWM dimming

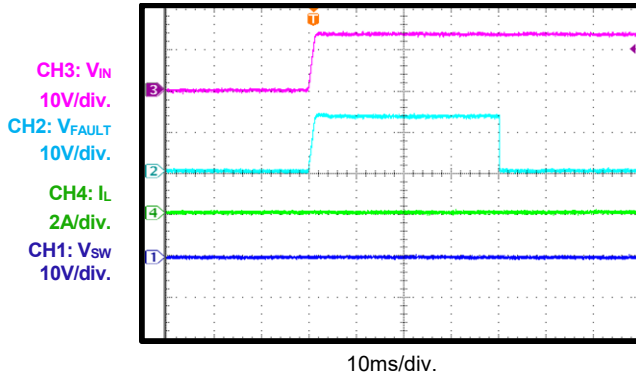

ISET Open before Start-Up
PWM dimming

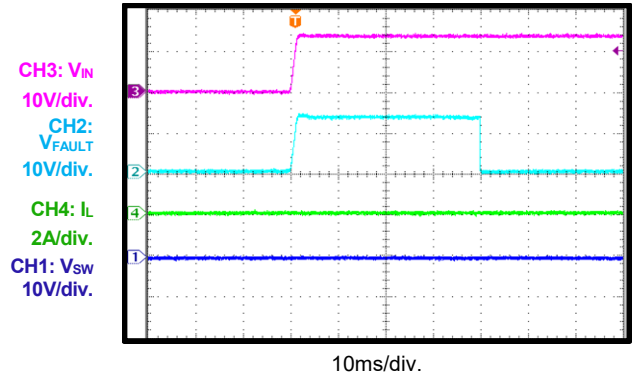

ISET Short after Start-Up

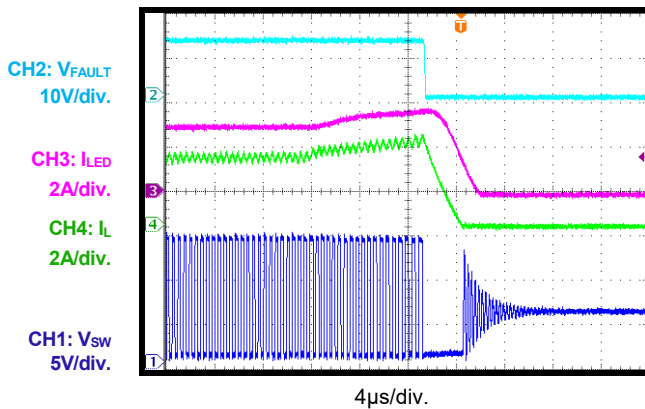

ISET Open after Start-Up

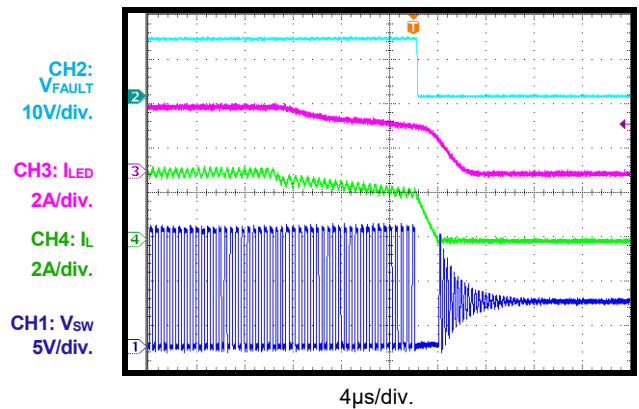

ISET Short after Start-Up
PWM dimming

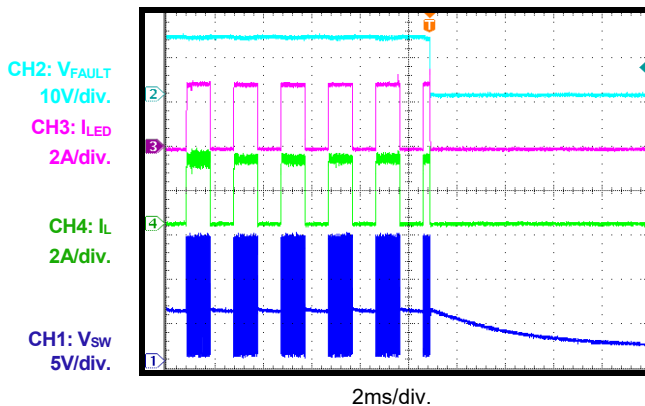

ISET Open after Start-Up
PWM dimming

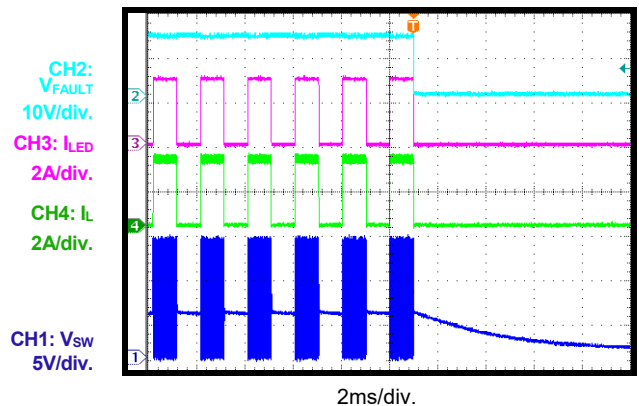

EVB TEST RESULTS *(continued)*

Performance curves and waveforms are tested on the evaluation board. $V_{IN} = 13.5V$, $V_{LED} = 6V$, $L = 4.7\mu H$, $f_{SW} = 2.3MHz$, $T_A = 25^\circ C$, in buck mode, unless otherwise noted.

DUTY Short before Start-Up

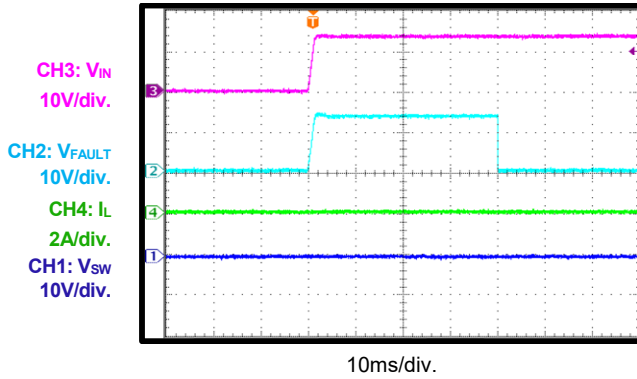

DUTY Open before Start-Up

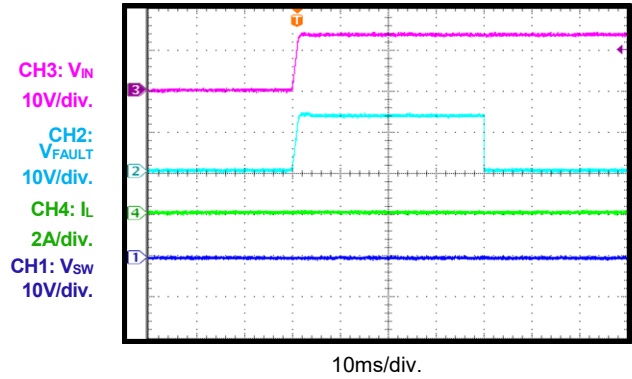

Mode Detect with Incorrect Configuration at VIN Start-Up

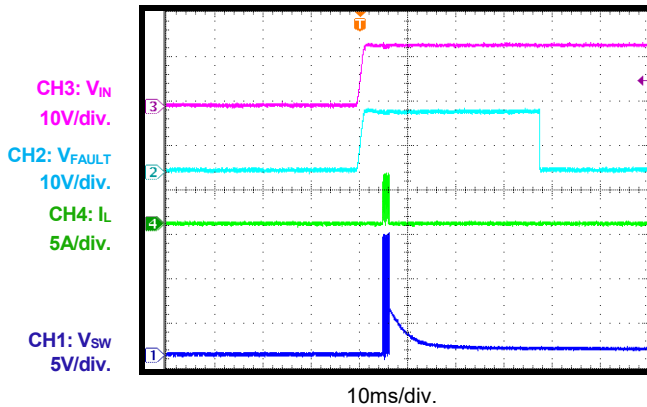

PCB LAYOUT

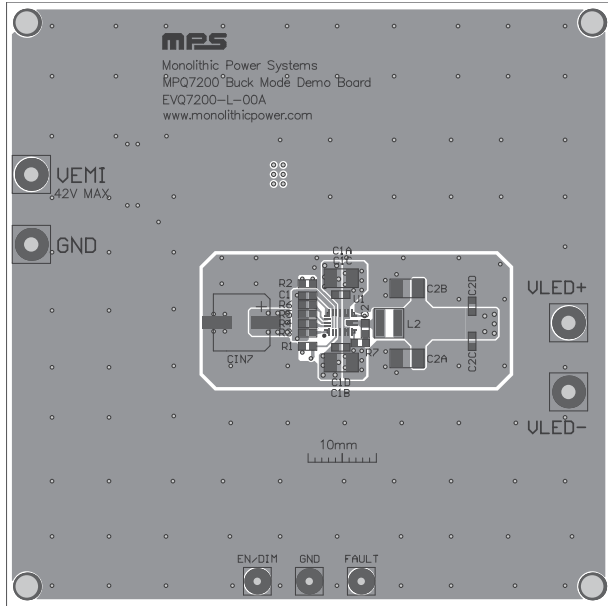

Figure 2: Top Silk and Top Layer

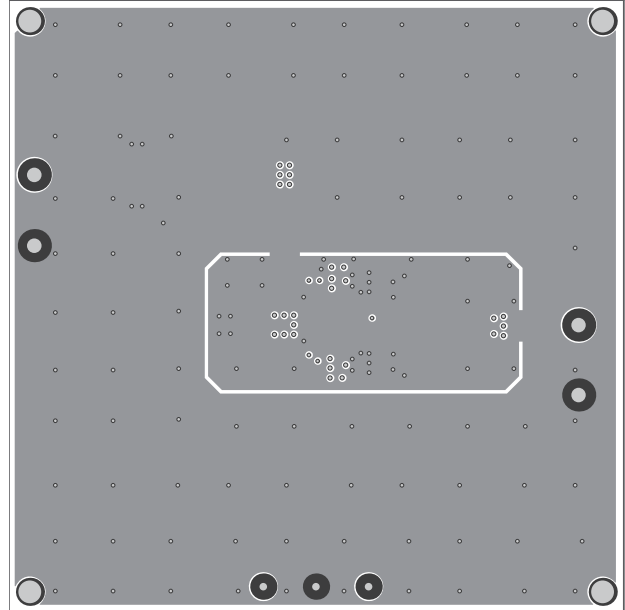

Figure 3: Mid-Layer 1

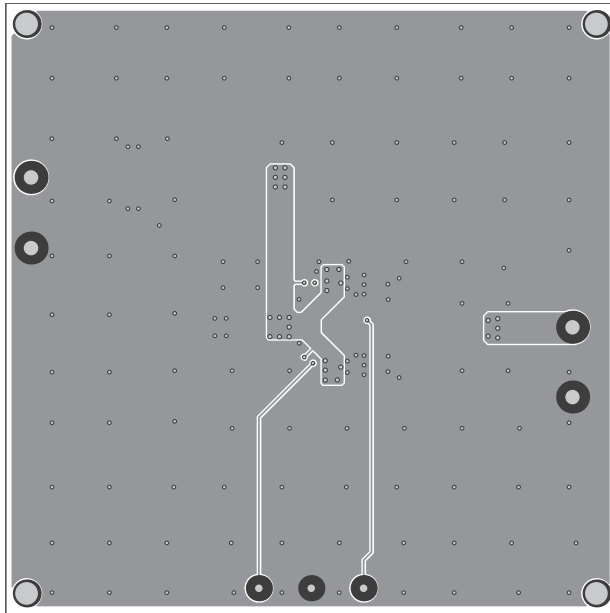

Figure 4: Mid-Layer 2

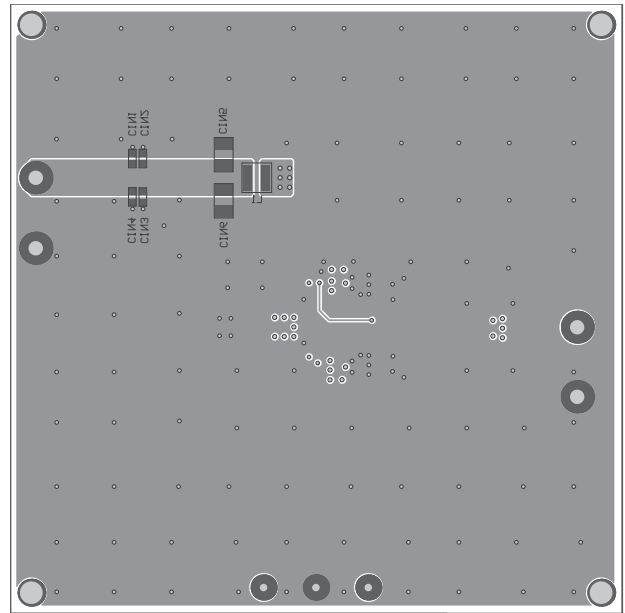

Figure 5: Bottom Layer and Bottom Silk

REVISION HISTORY

Revision #	Revision Date	Description	Pages Updated
1.0	1/4/2021	Initial Release	-

Notice: The information in this document is subject to change without notice. Please contact MPS for current specifications. Users should warrant and guarantee that third-party Intellectual Property rights are not infringed upon when integrating MPS products into any application. MPS will not assume any legal responsibility for any said applications.