



EVQ5872-RP-00A

42V Load Dump Test, 60mΩ, Single-Channel, Smart High-Side Load Switch Evaluation Board, AEC-Q100 Qualified

DESCRIPTION

The EVQ5872-RP-00A evaluation board is designed to demonstrate the capabilities of the MPQ5872, a smart high-side power switch for a nominal 2A load. It can support a wide 3.5V to 28V input voltage (V_{IN}) range.

The device supports both an internal current limit and a configurable, highly accurate external current limit. These limits clamp the inrush current under short-circuit conditions, which improves system reliability. An adjustable start-up slew rate also helps to reduce inrush current during start-up.

The FT/CS pin provides highly accurate current sensing, which achieves accurate diagnostics in real time without additional calibration. The voltage on the FT/CS pin represents $1 / K_{CS}$ of

the load current, where K_{CS} is a constant value across the temperature and supply voltage ranges. The FT/CS pin can report faults by pulling up its voltage.

The MPQ5872 provides full diagnostic capabilities when it is in both on and off states. By pulling the DIAG_EN pin up or down, users can enable or disable off-state open load or battery short detection. If the system does not require off-state diagnostics, turn off this function and reduce the standby current by connecting the DIAG_EN pin to the GND pin.

The MPQ5872 is available in a QFN-8 (2mmx2.5mm) package, and is available in AEC-Q100 Grade 1 and AEC-Q100-012 Test Grade A.

PERFORMANCE SUMMARY

Specifications are at $T_A = 25^\circ\text{C}$, unless otherwise noted.

Parameters	Conditions	Value
Recommended continuous supply voltage		5V to 28V
Maximum input voltage (V_{IN}) range for short circuit protection		24V
Maximum load dump voltage		42V
Maximum output current (I_{OUT})		2A

EVQ5872-RP-00A EVALUATION BOARD

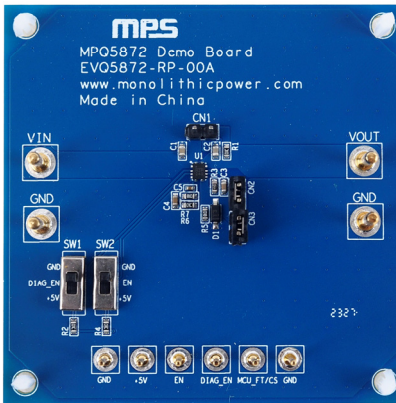

LxWxH (6.3cmx6.3cmx1cm)

Board Number	MPS IC Number
EVQ5872-RP-00A	MPQ5872GRPE-AEC1

QUICK START GUIDE

1. Preset the power supply (V_{IN}) between 5V and 28V, then turn the power supply off.
2. Electronic loads represent a negative impedance to the regulator, and setting a current too high may trigger over-current protection (OCP).

Do not use constant-current load mode for the electronic load. This may result in excessive heat on the integrated MOSFET, which can damage the IC.

3. Select a proper current limit that can support the load current during start-up. For detailed information on setting up the current limit, refer to the Electrical Characteristics section and the Internal Current Limit and Configurable External Current Limit section in the MPQ5872's datasheet.

The current-limit resistor (R_{CL}) can be calculated with Equation (1):

$$R_{CL} = \frac{K_{CL} \times V_{TH_LIM}}{I_{CL}} \quad (1)$$

Where R_{CL} is in Ω , V_{TH_LIM} is 0.7V, $K_{CL} = 1000$, and I_{CL} is the expected current limit (in A).

If using the internal current, short ILIM to the IC's GND via CN2.

4. To use the configurable soft-start (SS) function, select a proper SS capacitor (C_{SS}). An internal $10\mu A$ constant-current source (I_{SS}) charges the SS capacitor and ramps up the voltage on the SS pin (V_{SS}). V_{OUT} follows ($V_{SS} \times K_{SS}$) during the SS time. Typically, K_{SS} is about 16.7.

The V_{OUT} rising time (t_{VO_RISING}) can be estimated with Equation (2):

$$t_{VO_RISING} = \frac{1}{K_{SS}} \times \frac{V_{OUT}(V) \times C_{SS}(nF)}{I_{SS}(\mu A)} \quad (2)$$

5. For information on standby mode, diagnostic mode, and normal mode, refer to the MPQ5872's datasheet. Figure 1 shows the operation mode state machine.

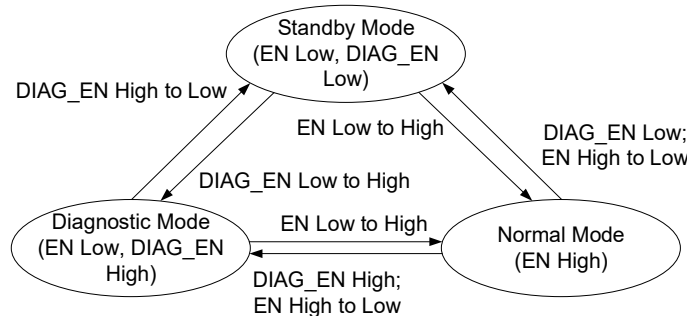

Figure 1: Operation Mode State Machine

6. To use the current-sense (CS) function, select a proper current-sense resistor and ensure the CS voltage is within a linear range (3V) during normal operation. Remove the CS resistor if the current-sense function is not used.
7. To use off-state open-load detection, short CN1. For detailed information, refer to the Open-Load Detection section in the MPQ5872's datasheet.

8. To use the enable function, apply a digital input to the EN pin. Pull EN above the specified threshold (1.2V) to enable the chip. Pull EN below the threshold (1V) to shut down the chip. The EN and DIAG_EN pins can be controlled by SW1 and SW2 if +5V is sourced by a power supply.
 9. CN3 is in parallel with a ground network (D1 and R5), which can protect the IC from reverse polarity connections or switch off the inductive load. Short CN3 if the ground network is not needed.
 10. Connect the power supply terminals to:
 - a. Positive (+): VIN
 - b. Negative (-): GND
 11. Connect the load terminals to:
 - a. Positive (+): VOUT
 - b. Negative (-): GND
 12. After making the connections, turn the power supply on. Use EN to control the device's on/off state.
- Figure 2 shows the measurement equipment set-up.

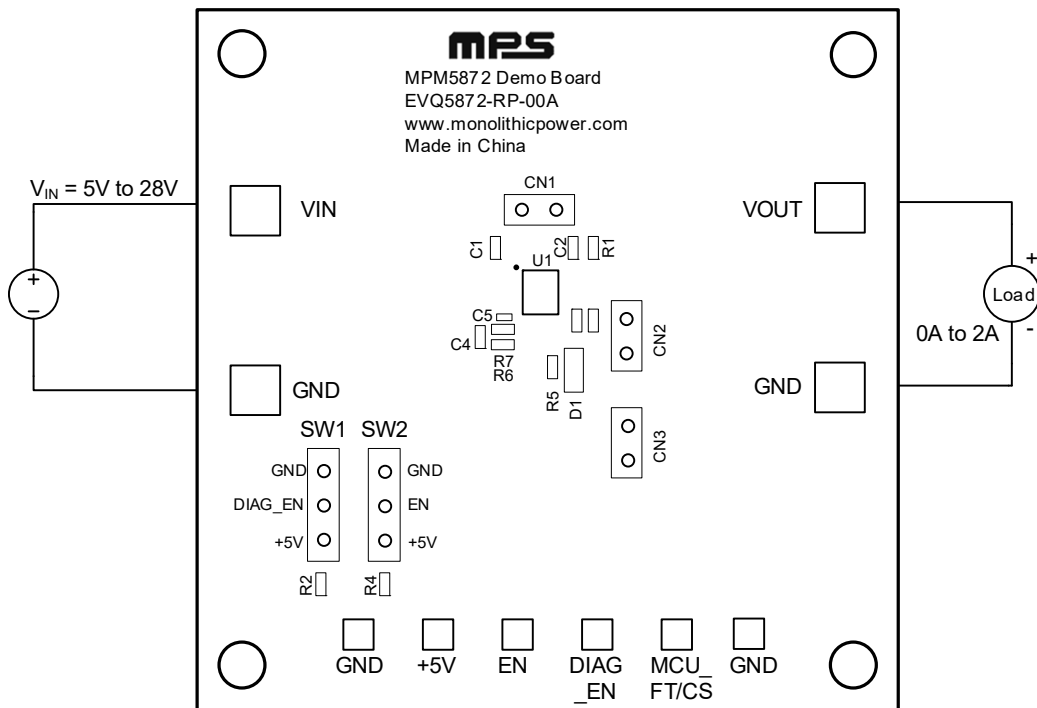

Figure 2: Measurement Equipment Set-Up

EVALUATION BOARD SCHEMATIC

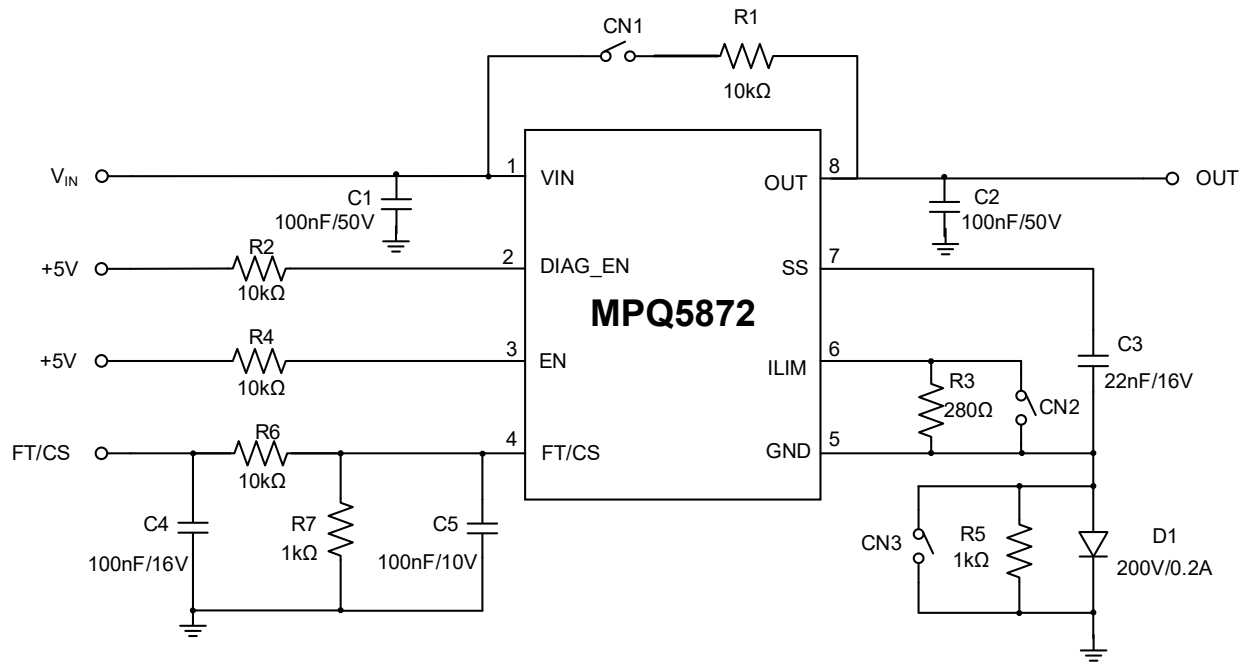
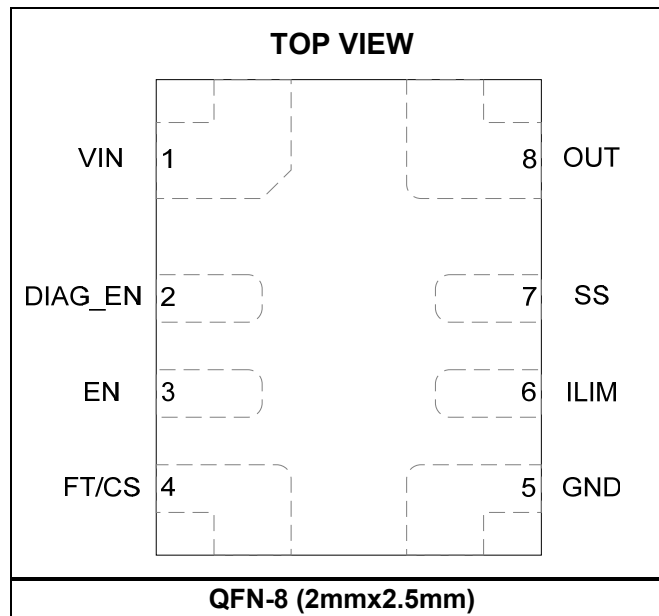

Figure 3: Evaluation Board Schematic

PACKAGE REFERENCE



EVQ5872-RP-00A BILL OF MATERIALS

Qty	Ref	Value	Description	Package	Manufacturer	Manufacturer PN
2	C1, C2	100nF	Ceramic capacitor, 50V, X7R	0603	Murata	GRM188R71H104KA93D
1	C3	22nF	Ceramic capacitor, 16V, X7R	0603	Murata	GRM188R71C223KA01D
1	C4	100nF	Ceramic capacitor, 16V, X7R	0603	Murata	GRM188R71C104KA01D
1	C5	100nF	Ceramic capacitor, 10V, X7R	0402	Murata	GRM155R71C104KA88D
4	R1, R2, R4, R6	10kΩ	Film resistor, 1%	0603	Yageo	RC0603FR-0710KL
1	R3	280Ω	Film resistor, 1%	0603	Yageo	RC0603FR-07280RL
2	R5, R7	1kΩ	Film resistor, 1%	0603	Yageo	RC0603FR-071KL
1	D1	200V/0.2A	Diode	SOD-123	Diodes, Inc.	BAV21W
1	U1	MPQ5872	42V load dump, 60mΩ, smart high-side switch	QFN-8 (2mmx2.5mm)	MPS	MPQ5872GRPE-AEC1

EVB TEST RESULTS

Performance curves and waveforms are tested on the evaluation board. $V_{IN} = 12V$, $V_{OUT} = 12V$, $C_{LOAD} = 47\mu F$, $T_A = 25^\circ C$, unless otherwise noted.

Start-Up through VIN

$I_{OUT} = 0A$

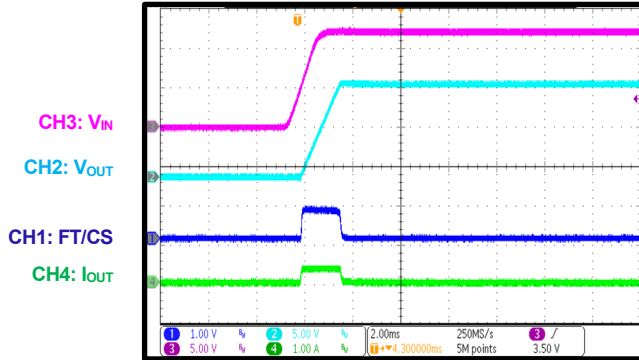

Start-Up through VIN

$I_{OUT} = 2A$

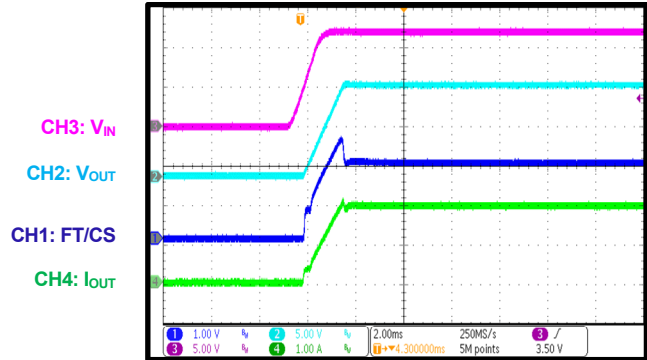

Shutdown through VIN

$I_{OUT} = 0A$

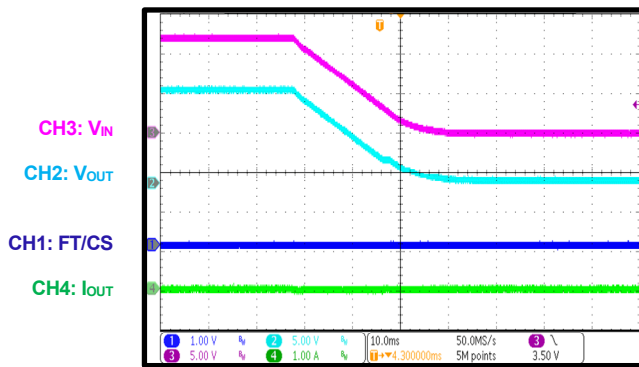

Shutdown through VIN

$I_{OUT} = 2A$

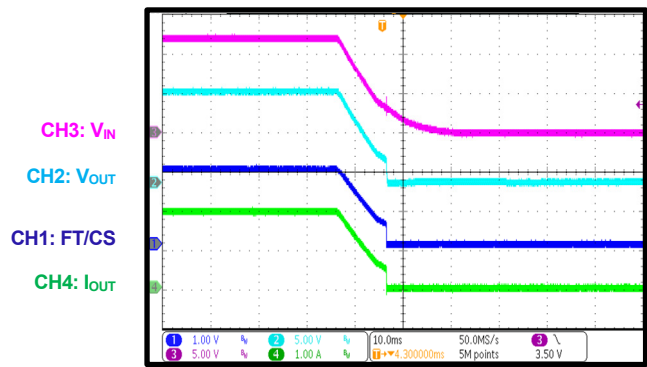

Start-Up through EN

$I_{OUT} = 0A$

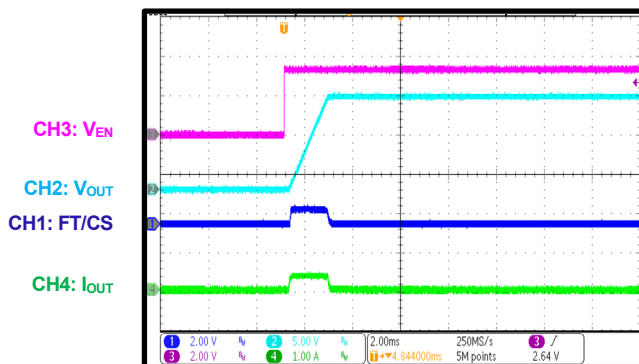

Start-Up through EN

$I_{OUT} = 2A$

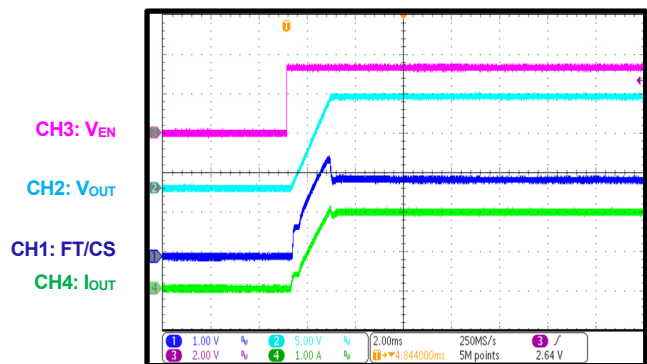

EVB TEST RESULTS (continued)

Performance curves and waveforms are tested on the evaluation board. $V_{IN} = 12V$, $V_{OUT} = 12V$, $C_{LOAD} = 47\mu F$, $T_A = 25^\circ C$, unless otherwise noted.

Shutdown through EN

$I_{OUT} = 0A$

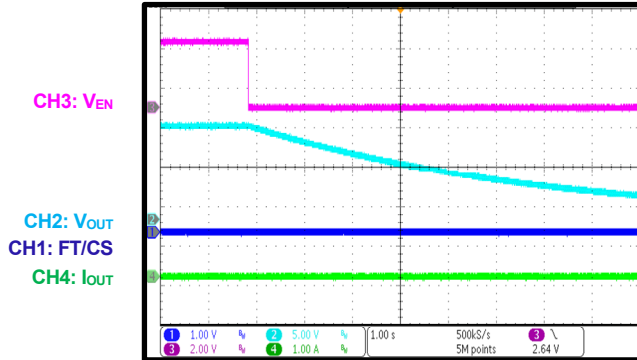

Shutdown through EN

$I_{OUT} = 2A$

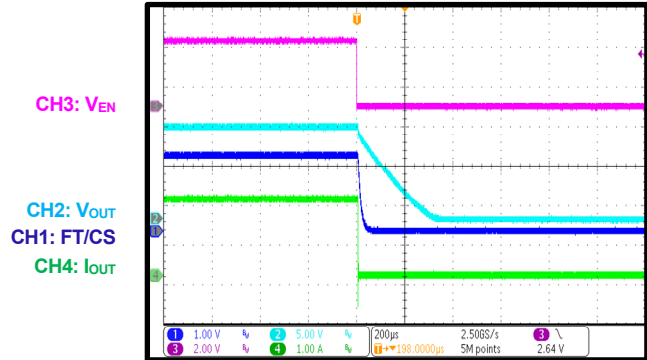

SCP Entry

$I_{OUT} = 0A$

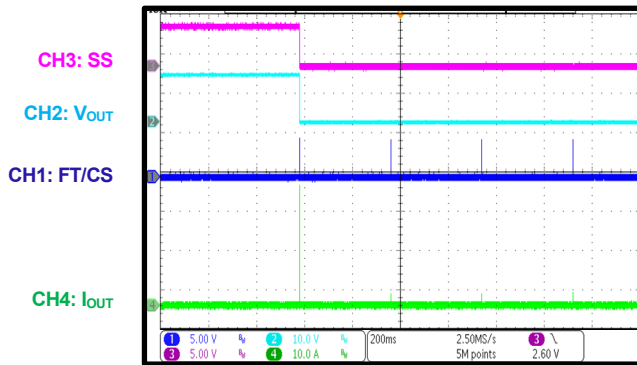

SCP Entry

$I_{OUT} = 0A$

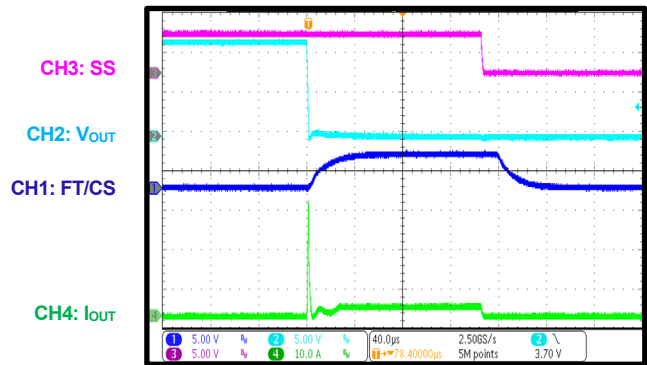

SCP Entry

$I_{OUT} = 2A$

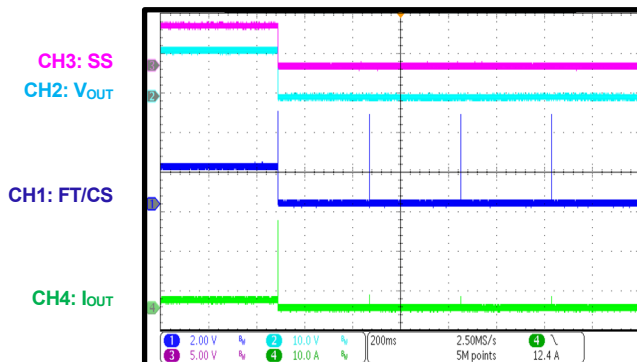

SCP Entry

$I_{OUT} = 2A$

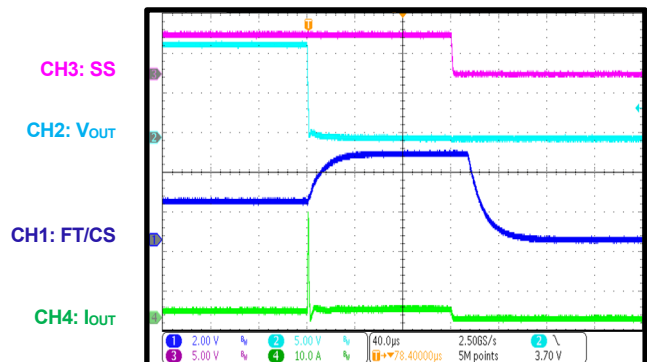

EVB TEST RESULTS (continued)

Performance curves and waveforms are tested on the evaluation board. $V_{IN} = 12V$, $V_{OUT} = 12V$, $C_{LOAD} = 47\mu F$, $T_A = 25^\circ C$, unless otherwise noted.

SCP Steady State

$I_{OUT} = 0A$

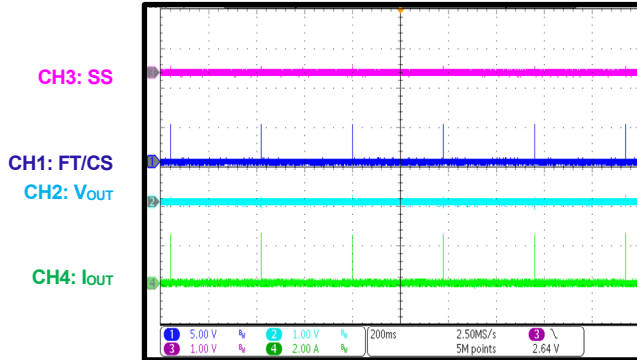

SCP Recovery

$I_{OUT} = 0A$

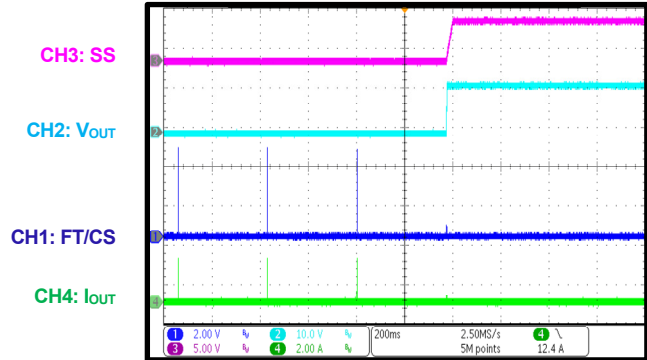

SCP Recovery

$I_{OUT} = 2A$

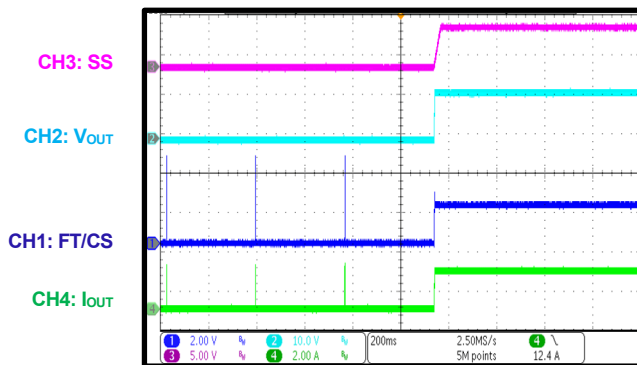

SCP Start-Up

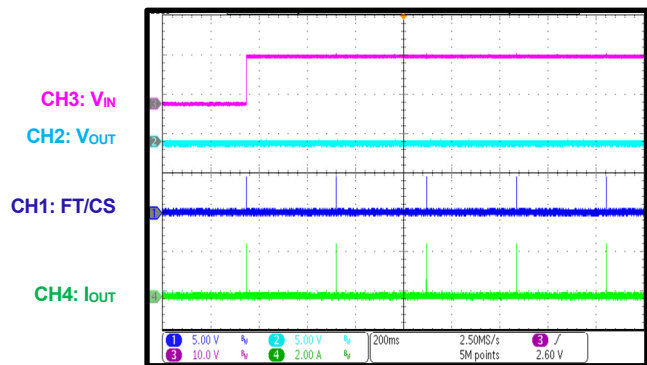

SCP Shutdown

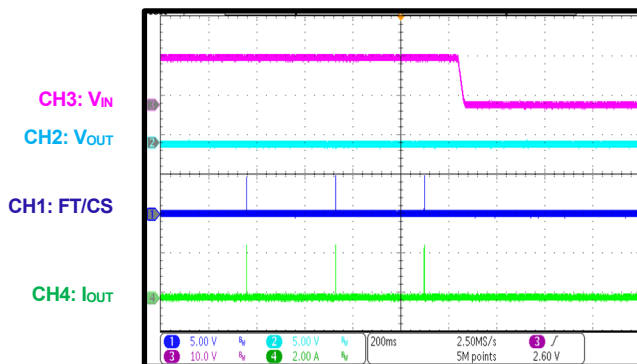

SCP (EN On)

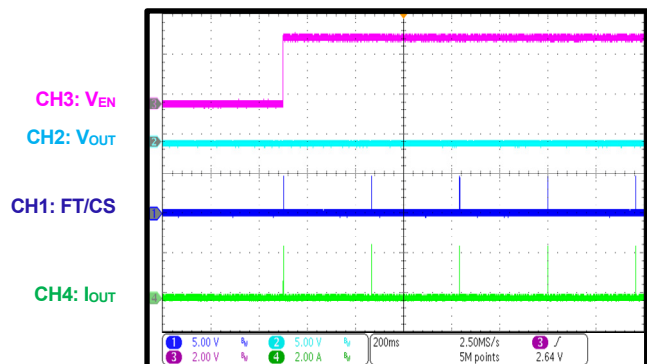

EVB TEST RESULTS (continued)

Performance curves and waveforms are tested on the evaluation board. $V_{IN} = 12V$, $V_{OUT} = 12V$, $C_{LOAD} = 47\mu F$, $T_A = 25^\circ C$, unless otherwise noted.

SCP (EN Off)

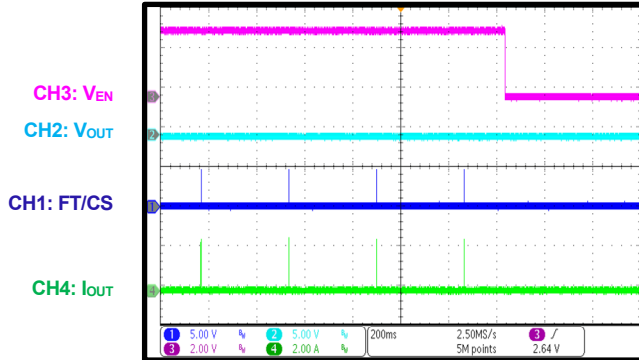

OCP

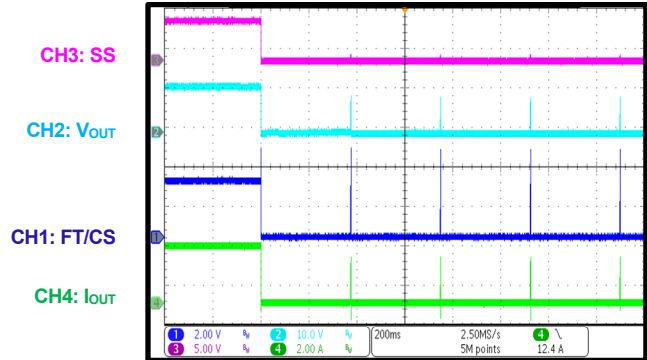

Open-Load Detection

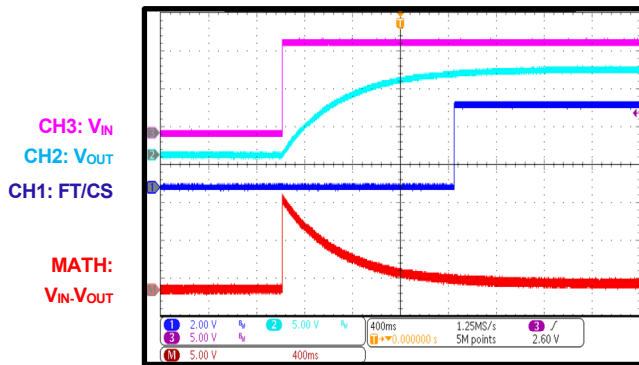

Load Dump

$I_{OUT} = 0A$

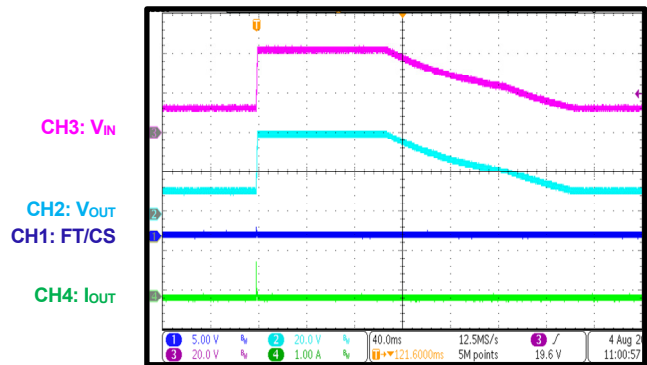

Load Dump

$I_{OUT} = 2A$

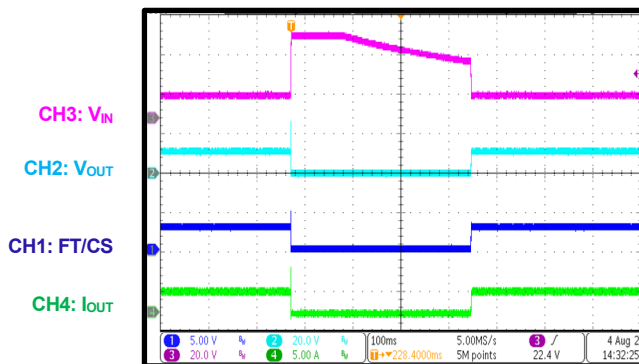

Cold Crank

$I_{OUT} = 0A$

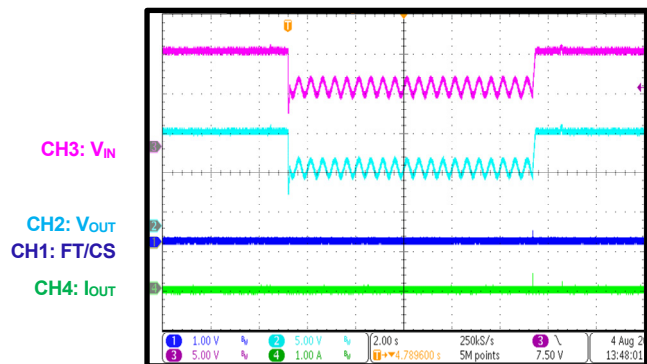

EVB TEST RESULTS *(continued)*

Performance curves and waveforms are tested on the evaluation board. $V_{IN} = 12V$, $V_{OUT} = 12V$, $C_{LOAD} = 47\mu F$, $T_A = 25^\circ C$, unless otherwise noted.

Cold Crank

$I_{OUT} = 2A$

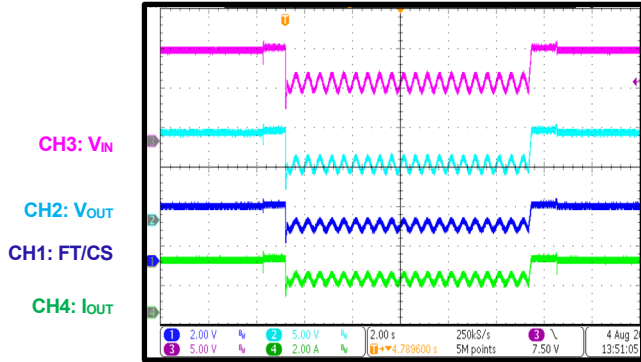

PCB LAYOUT (1)

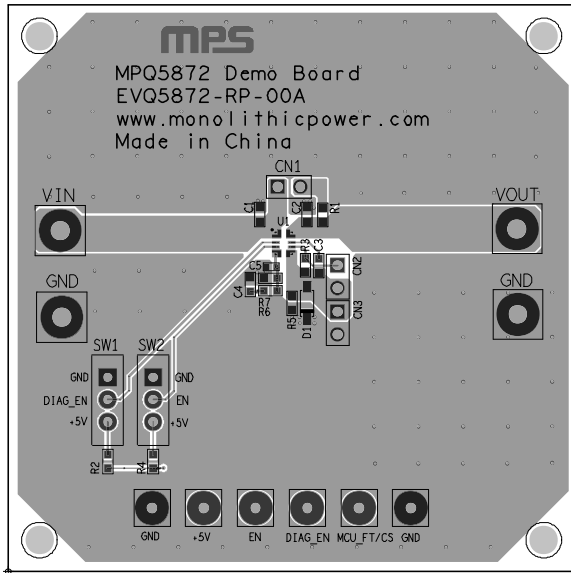

Figure 4: Top Silk and Top Layer

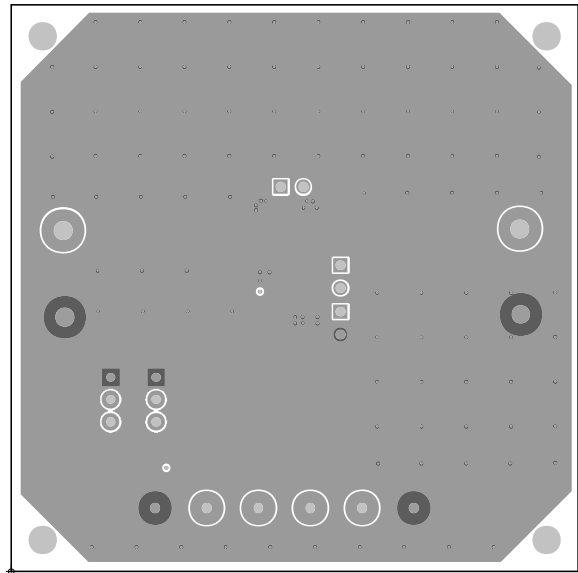

Figure 5: Mid-Layer 1

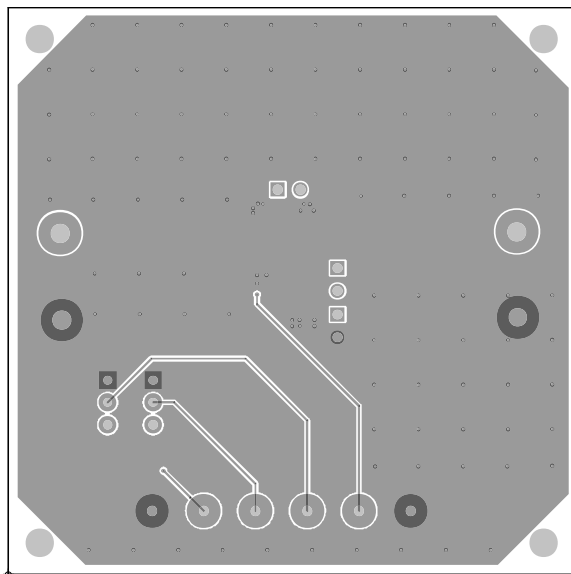

Figure 6: Mid-Layer 2

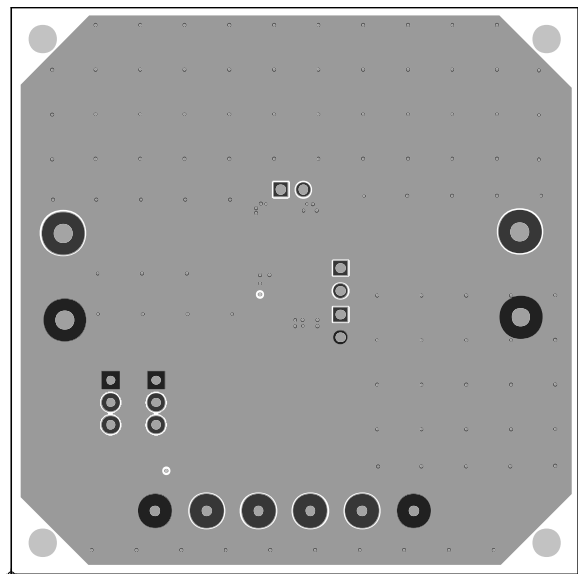

Figure 7: Bottom Layer and Bottom Silk

Note:

- 1) The copper thickness of all layers is 2oz.



REVISION HISTORY

Revision #	Revision Date	Description	Pages Updated
1.0	10/30/2023	Initial Release	-

Notice: The information in this document is subject to change without notice. Please contact MPS for current specifications. Users should warrant and guarantee that third-party Intellectual Property rights are not infringed upon when integrating MPS products into any application. MPS will not assume any legal responsibility for any said applications.