



The Future of Analog IC Technology®

EVQ4456-QT-00A

1A, 36V, 4MHz

Step-Down Converter Evaluation Board

DESCRIPTION

The EVQ4456-QT-00A is an evaluation board for the MPQ4456, a high frequency step-down regulator with an integrated power MOSFET.

The MPQ4456 integrates a 300mΩ MOSFET that provides 1A load current over a wide operating input voltage of 3.8V to 36V.

Current mode control provides fast transient response and eases loop stabilization. An internal soft-start prevents inrush current at turn-on.

The EVQ4456-QT-00A is a fully assembled and tested PCB. It generates a +3.3V output voltage at load current up to 1A from an 8V to 36V input range. Switching frequency is set at 500kHz.

ELECTRICAL SPECIFICATIONS

Parameter	Symbol	Value	Units
Input Voltage	V_{IN}	8 – 36	V
Output Voltage	V_{OUT}	3.3	V
Output Current	I_{OUT}	1	A

FEATURES

- 1A Output Current
- Programmable Switching Frequency up to 4MHz
- Wide 8V to 36V Operating Input Range
- Adjustable Output from 0.8V
- Fully Assembled and Tested

APPLICATIONS

- High Voltage Power Conversion
- Game Machines
- Automotive Systems
- Industrial Power Systems
- Distributed Power Systems
- Printer Systems
- Battery Powered Systems

All MPS parts are lead-free and adhere to the RoHS directive. For MPS green status, please visit MPS website under Quality Assurance. "MPS" and "The Future of Analog IC Technology" are Registered Trademarks of Monolithic Power Systems, Inc.

EVQ4456-QT-00A EVALUATION BOARD

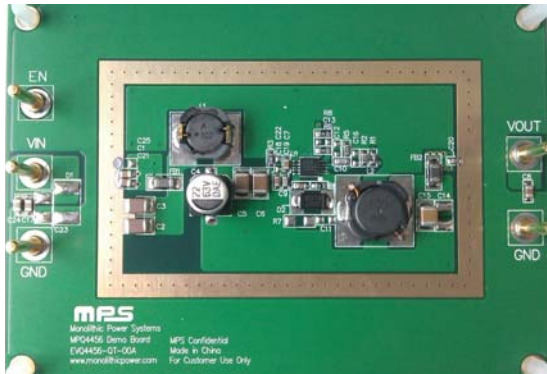

(L x W x H) 3.5" x 2.5" x 0.4"
(8.8cm x 6.4cm x 1.0cm)

Board Number	MPS IC Number
EVQ4456-QT-00A	MPQ4456GQT

Efficiency vs. Output Current

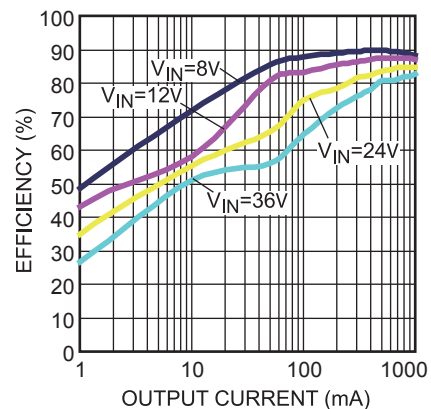

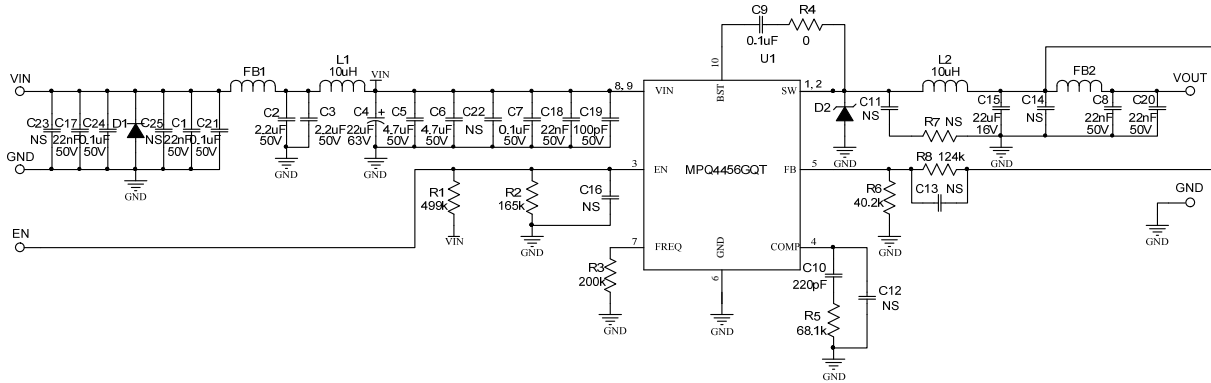
EVALUATION BOARD SCHEMATIC

EVQ4456-QT-00A BILL OF MATERIALS

Qty	Ref	Value	Description	Package	Manufacture	Part Name
3	C1, C8, C17	22nF	Ceramic Capacitor; 50V; X7R; 0805	0805	TDK	C2012X7R1H223K
2	C2, C3	2.2µF	Ceramic Capacitor; 50V; X7R; 1210	1210	TDK	C3225X7R1H225K
1	C4	22µF	Electrolytic Capacitor; 63V; Φ6.3mmx7.7mm(H)	SMD	Jianghai	VTD-63V22
2	C5, C6	4.7µF	Ceramic Capacitor; 50V; X7R; 1210	1210	TDK	C3225X7R1H475K
2	C7, C9	0.1µF	Ceramic Capacitor; 50V; X7R; 0603	0603	TDK	C1608X7R1H104K
1	C10	220pF	Ceramic Capacitor; 50V; X7R; 0603	0603	TDK	C1608X7R1H221K
1	C15	22µF	Ceramic Capacitor; 16V; X7R; 1210	1210	TDK	C3235X7R1C226M
1	C18	22nF	Ceramic Capacitor; 50V; X7R; 0603	0603	TDK	C1608X7R1H223K
1	C19	100pF	Ceramic Capacitor; 50V; C0G; 0603	0603	TDK	C1608C0G1H101J
1	C20	22nF	Ceramic Capacitor; 50V; X7R; 0603	0603	TDK	C1608X7R1H223K
2	C21, C24	0.1µF	Ceramic Capacitor; 50V; X7R; 0805	0805	TDK	C2012X7R1H104K
2	C11, C25	NS		0805		
4	C12, C13, C16, C22	NS		0603		
2	C14, C23	NS		1210		
1	D1	NS		SMB		

EVQ4456-QT-00A BILL OF MATERIALS (continued)

Qty	Ref	Value	Description	Package	Manufacture	Part Name
1	D2	B240A	Diode Schottky; 40V; 2A	SMA	Diodes	B240A
5	EN, GND1, GND2, VIN, VOUT		2.0 Golden Pin		HZ	
2	FB1, FB2		Magnetic Bead; 6A	1206	muRata	BLM31PG330SH1L
1	L1	10uH	Inductor; 2.7A; 38mohm	SMD	TDK	CLF7045T-100M-H
			Inductor; 2.4A; 45mohm	SMD	TOKO	DS85LCB-B1135AS-100M
1	L2	10uH	Inductor; 4A; 26mohm	SMD	TDK	CLF10040T-100M-H
			Inductor; 4.3A; 26.5mohm	SMD	TOKO	D104C-919AQ-100M
1	R1	499k	Film Resistor; 1%	0603	Yageo	RC0603FR-07499KL
1	R2	165k	Film Resistor; 1%	0603	Yageo	RC0603FR-07165KL
1	R3	200k	Film Resistor; 1%	0603	Yageo	RC0603FR-07200KL
1	R4	0	Film Resistor; 5%	0603	Yageo	RC0603JR-070RL
1	R5	68.1k	Film Resistor; 1%	0603	Yageo	RC0603FR-0768K1L
1	R6	40.2k	Film Resistor; 1%	0603	Yageo	RC0603FR-0740K2L
1	R7	NS		1206		
1	R8	124k	Film Resistor; 1%	0603	Yageo	RC0603FR-07124KL
1	U1	MPQ4456 GQT	Step-Down Regulator	QFN3*3	MPS	MPQ4456GQT

EVB TEST RESULTS

Performance waveforms are tested on the evaluation board.

$V_{IN} = 12V$, $V_{OUT} = 3.3V$, $T_A = 25^\circ C$, unless otherwise noted.

Output Voltage Ripple

$I_{OUT} = 0.1A$

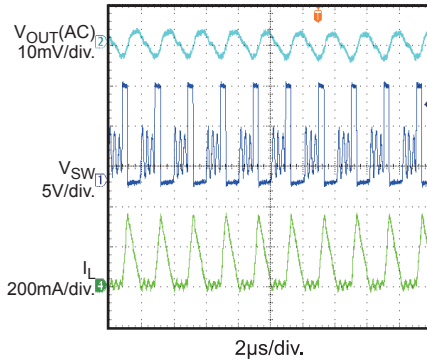

Output Voltage Ripple

$I_{OUT} = 1A$

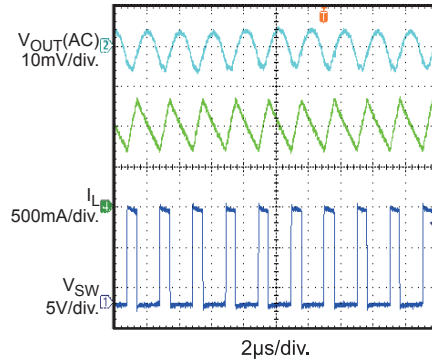

Power On

$I_{OUT} = 0A$

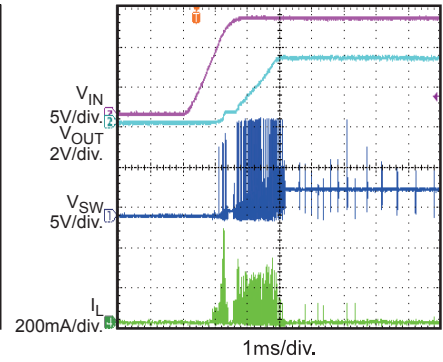

Power On

$I_{OUT} = 1A$

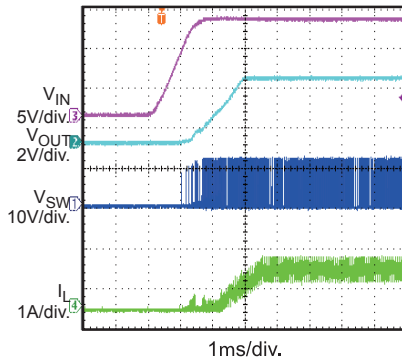

Power Off

$I_{OUT} = 0A$

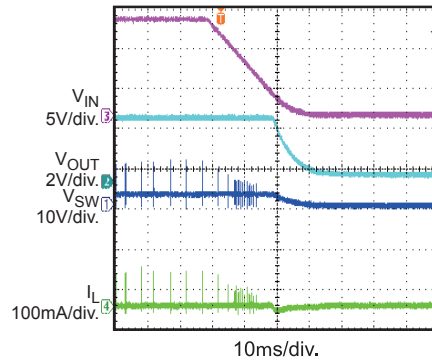

Power Off

$I_{OUT} = 1A$

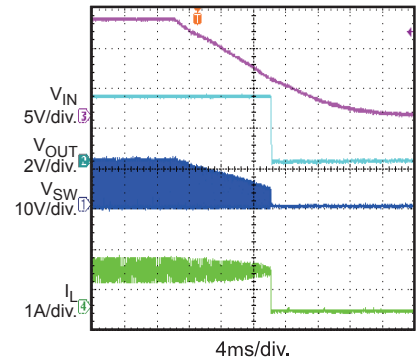

En On

$I_{OUT} = 0A$

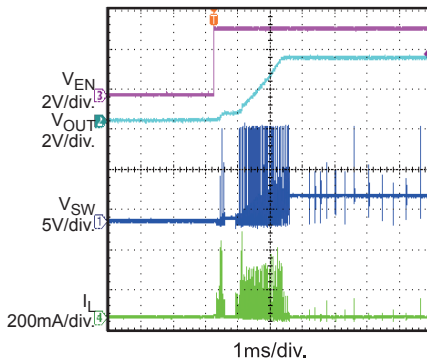

En On

$I_{OUT} = 1A$

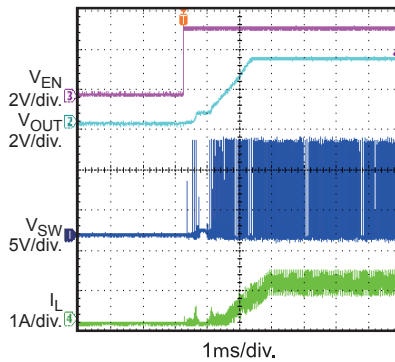

En Off

$I_{OUT} = 0A$

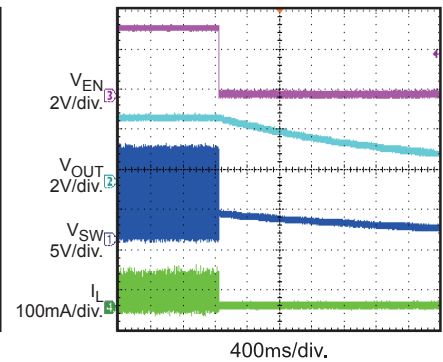

EVB TEST RESULTS *(continued)*

Performance waveforms are tested on the evaluation board.

$V_{IN} = 12V$, $V_{OUT} = 3.3V$, $T_A = 25^\circ C$, unless otherwise noted.

En Off
 $I_{OUT} = 1A$

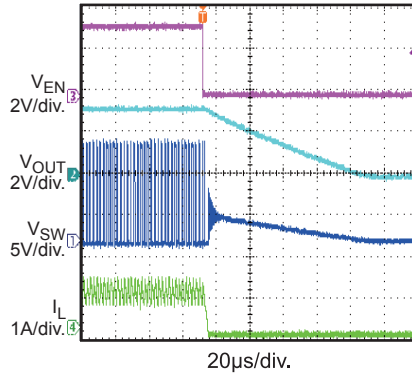

Load Transient Response
 $I_{OUT} = 0A$ to $1A$, $1.6A/\mu s$

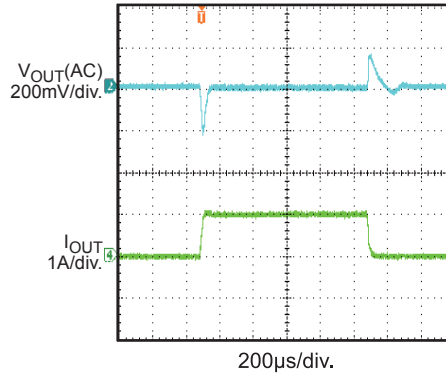

Short Circuit Protection
 $I_{OUT} = 1A$

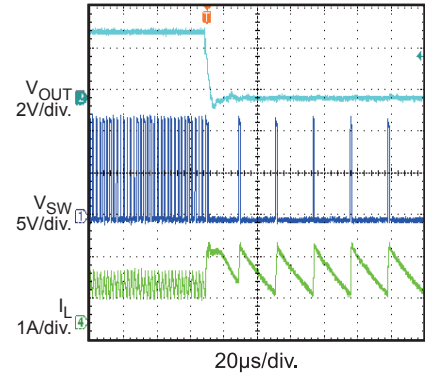

PRINTED CIRCUIT BOARD LAYOUT

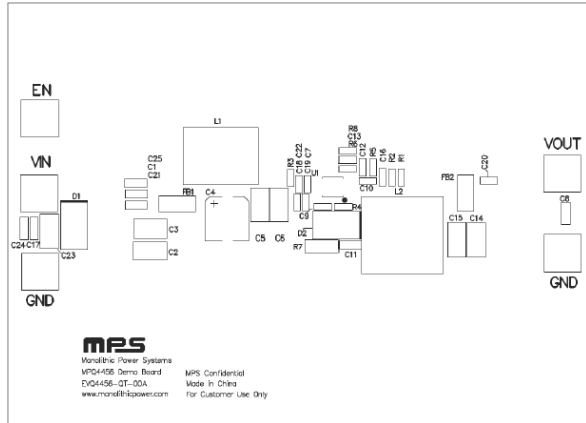

Figure 1—Top Silk Layer

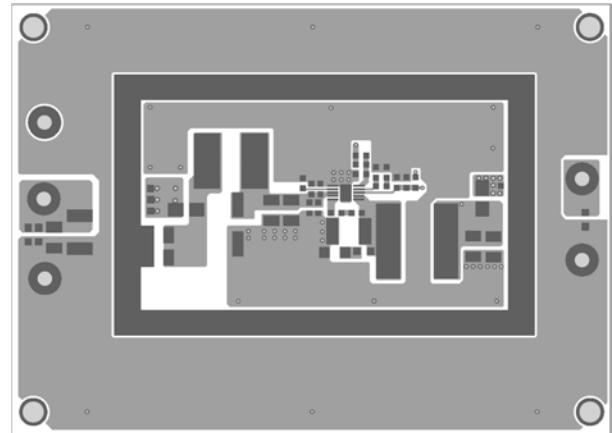

Figure 2—Top Layer

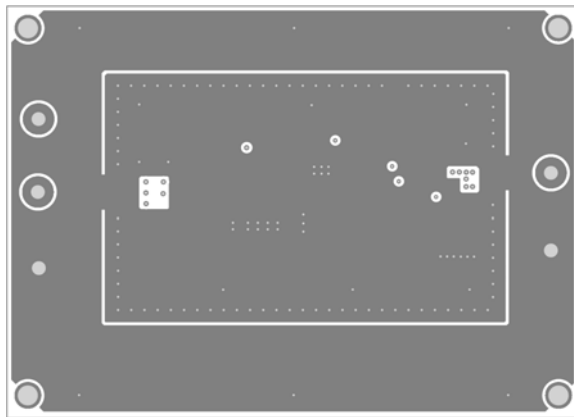

Figure 3—Inner1 Layer

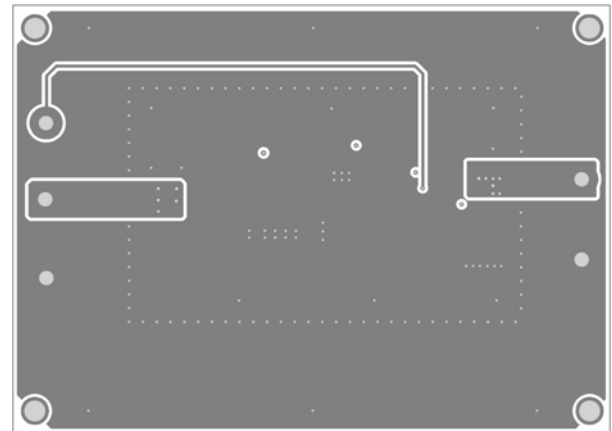

Figure 4—Inner2 Layer

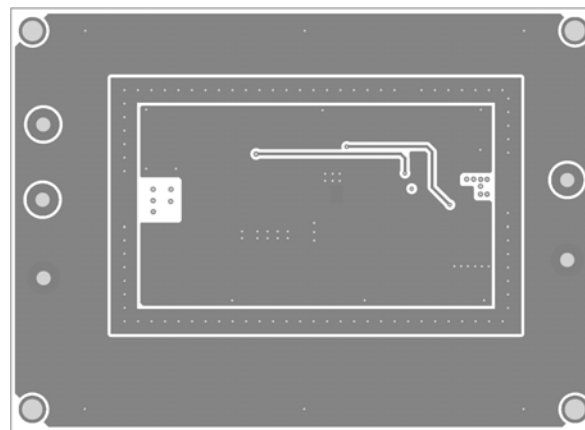

Figure 5—Bottom Layer

QUICK START GUIDE

1. Connect the positive and negative terminals of the load to the VOUT and GND pins, respectively.
2. Preset the power supply output to between 8 and 36V, and then turn it off.
3. Connect the positive and negative terminals of the power supply output to the VIN and GND pins, respectively.
4. Turn the power supply on. The MPQ4456GQT will automatically startup.
5. To use the Enable function, apply a digital input to the EN pin. Drive EN higher than 1.55V to turn on the regulator, drive EN less than 1.23V to turn it off.
6. An input under voltage lockout (UVLO) function is implemented by the addition of a resistor divider R1 and R2. The EN threshold is 1.23V (falling edge), so V_{IN} UVLO threshold is $1.23V \times \left(1 + \frac{R1}{R2}\right)$. It is preset to around 3.8V on this board.
7. Use R6 and R8 to set the output voltage with $V_{FB} = 0.8V$. For $R6 = 23.7k\Omega$, R8 can be determined by: $R8 = 29.625 \times (V_{OUT} - 0.8) (k\Omega)$. Follow the Application Information section in the device datasheet to recalculate the compensation, inductor and output capacitor values when output voltage is changed.

NOTICE: The information in this document is subject to change without notice. Users should warrant and guarantee that third party Intellectual Property rights are not infringed upon when integrating MPS products into any application. MPS will not assume any legal responsibility for any said applications.