



EVQ4436-R-00A

45V, 6A, Low I_Q, Synchronous, Step-Down Converter Evaluation Board

DESCRIPTION

The EVQ4436-R-00A evaluation board is designed to demonstrate the capabilities of MPS's MP/MPQ4436.

The MP/MPQ4436 is a frequency-configurable, synchronous, step-down, switching regulator with integrated internal high-side and low-side power MOSFETs. It provides up to 6A of highly efficient output, with current mode control for fast loop response.

The wide 3.3V to 45V input range accommodates a variety of step-down applications in an automotive input environment. A 1.7 μ A shutdown mode quiescent current allows the part to be used in battery-powered applications.

High power conversion efficiency over a wide load range is achieved by scaling down the switching frequency in light-load conditions to reduce the switching and gate-driving losses.

Frequency foldback prevents inductor current runaway during start-up. Thermal shutdown provides reliable, fault-tolerant operation.

High duty cycle and low dropout mode are provided for automotive cold crank condition.

ELECTRICAL SPECIFICATION

Parameter	Symbol	Value	Units
Input voltage	V _{IN}	3.3 to 45	V
Output voltage	V _{OUT}	3.3	V
Output current	I _{OUT}	6	A

FEATURES

- Wide 3.3V to 45V Operating Voltage Range
- 6A Continuous Output Current
- 1.7 μ A Low Shutdown Supply Current
- 18 μ A Sleep Mode Quiescent Current
- Internal 48m Ω High-Side and 20m Ω Low-Side MOSFET
- 350kHz to 530kHz Programmable Switching Frequency for Car Battery Applications
- Synchronize to External Clock
- Multi-Phase Capability
- Out-of-Phase Synchronized Clock Output
- Symmetric V_{IN} for Low EMI
- Power Good Output
- External Soft Start
- 100ns Minimum On Time
- Selectable AAM (Advanced Asynchronous Mode) or FCCM (Continuous Conduction Mode)
- Low Dropout Mode
- Hiccup Over-Current Protection
- Available in a QFN-20 (4mmx4mm) Wettable Flank Package
- AEC-Q100 Grade-1

APPLICATIONS

- Infotainment
- Clusters
- Advanced Driver Assistance Systems
- Industrial Power Systems

All MPS parts are lead-free, halogen-free, and adhere to the RoHS directive. For MPS green status, please visit the MPS website under Quality Assurance. "MPS", the MPS logo, and "Simple, Easy Solutions" are trademarks of Monolithic Power Systems, Inc. or its subsidiaries.

QUICK START GUIDE

1. Connect the positive and negative terminals of the load to the VOUT and GND pins, respectively. Set the load current between 0A and 6A. Electronic loads represent a negative impedance to the regulator. If they are set to an exceedingly high current, it will trigger over-current or short current protection.
2. Preset the power supply output between 3.3V and 45V, then turn it off. If longer cables are used between the source and the EVB (>0.5m total), install a damping capacitor at the input terminals. This is highly recommended when $V_{EMI} \geq 24V$.
3. Connect the positive and negative terminals of the power supply output to the VEMI and GND pins, respectively.
4. Turn the power supply on. The board will automatically start up. The default V_{OUT} is 3.3V.
5. To use the enable function, apply a digital input to the EN pin. Drive EN above 1V to turn on the regulator; drive EN below 0.85V to turn it off.
6. To use the sync function, apply a 350kHz to 530kHz external clock to the SYNCIN pin to synchronize the internal clock's rising edge.
7. JP1 selects forced CCM mode or AAM mode. Connecting pin 2 (mode) to pin 3 (VCC) of JP1 forces the MPQ4436 into forced CCM mode. Connecting pin 1 (GND) to pin 2 (mode) of JP1 forces the MPQ4436 into AAM mode.

EVQ4436-R-00A EVALUATION BOARD



(LxWxH) 9cmx9cmx1.3cm

Board Number	MPS IC Number
EVQ4436-R-00A	MP/MPQ4436GR

Efficiency vs. Load Current

$V_{OUT} = 3.3V$, AAM, $f_{SW} = 470kHz$

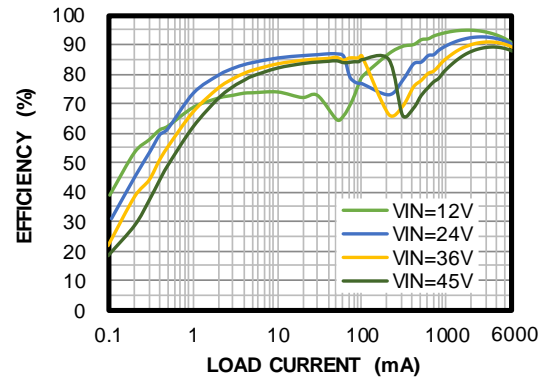

EVALUATION BOARD SCHEMATIC

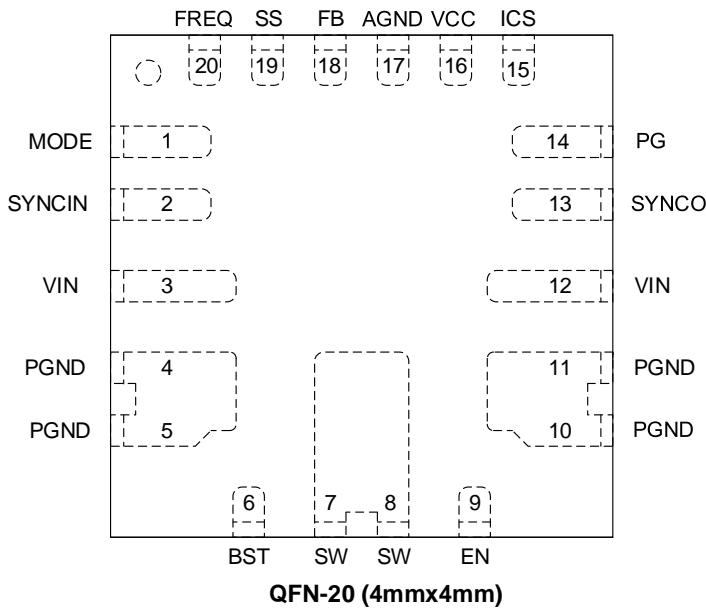
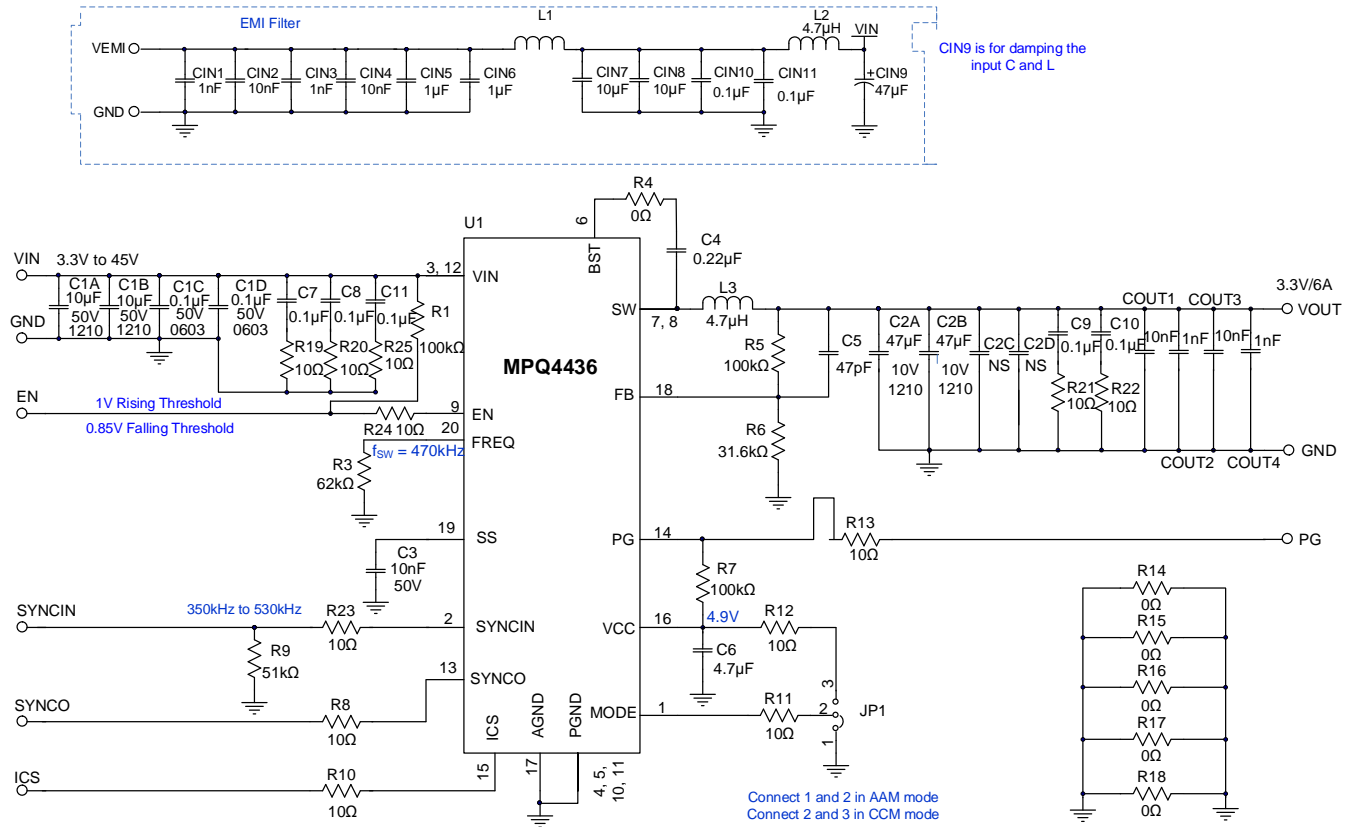

EVQ4436-R-00A BILL OF MATERIALS

Qty	Ref	Value	Description	Package	Manufacturer	Manufacturer P/N
4	CIN1, CIN3, COUT2, COUT4	1nF	Ceramic capacitor, 50V, X7R	0603	muRata	GRM216R71H102KA01
5	CIN2, CIN4, C3, COUT1, COUT3	10nF	Ceramic capacitor, 50V, X7R	0603	muRata	GRM188R71H103KA01D
2	CIN5, CIN6	1 μ F	Ceramic capacitor, 50V, X7R	0805	muRata	GRM21BR71H105KA12L
2	CIN7, CIN8	10 μ F	Ceramic capacitor, 50V, X5R	1206	muRata	GRM31CR61H106KA12L
1	CIN9	47 μ F	Aluminum capacitor, 63V	SMD	Panasonic	EEE-1JA470UP
2	C1A, C1B	10 μ F	Ceramic capacitor, 50V, X5R	1210	muRata	GRM32ER61H106KA12L
4	CIN10, CIN11, C1C, C1D	0.1 μ F	Ceramic capacitor, 50V, X7R	0603	muRata	GCJ188R71H104KA12D
2	C2A, C2B	47 μ F	Ceramic capacitor, 10V, X5R	1210	muRata	GRM32ER61A476KE20L
1	C4	0.22 μ F	Ceramic capacitor, 16V, X7R	0603	muRata	GRM188R71C122KA01D
1	C5	47pF	Ceramic capacitor, 50V, COG	0603	TDK	C1608C0G1H470J
1	C6	4.7 μ F	Ceramic capacitor, 10V, X5R	0603	muRata	GRM188R61A475KE15D
5	C7, C8, C9, C10, C11	0.1 μ F	Ceramic capacitor, 50V, X7R	0402	muRata	GRM155R71H104KE14D
2	C2C, C2D	NS				
1	L1		Magnetic bead, 6A	1806	muRata	BLM41PG600SN1L
1	L2	4.7 μ H	Inductor, 4.7 μ H, 31.5m, 6A	SMD	Cyntec	VCMT063T-4R7MN5T
1	L3	4.7 μ H	Inductor, 4.7 μ H, 14.4m, 11A	SMD	Coilcraft	XAL6060-472ME
1	R1	100k Ω	Film resistor, 1%	0402	Yageo	RC0402FR-07100KL
1	R3	62k	Film resistor, 1%	0603	Yageo	RC0603FR-062KL
5	R14, R15, R16, R17, R18	0	Film resistor, 1%	0402	Yageo	RC0402FR-070RL
1	R4	0	Film resistor, 5%	0603	Yageo	RC0603JR-070RL
1	R5	100k Ω	Film resistor, 1%	0603	Yageo	RC0603FR-07100KL
1	R6	31.6k Ω	Film resistor, 1%	0603	Yageo	RC0603FR-0731K6L
1	R7	100k Ω	Film resistor, 1%	0603	Yageo	RC0603FR-07100KL
1	R9	51k Ω	Film resistor, 1%	0603	Yageo	RC0603FR-0751KL

EVQ4436-R-00A BILL OF MATERIALS (continued)

Qty	Ref	Value	Description	Package	Manufacturer	Manufacturer_P/N
5	R19, R20, R21, R22, R25	10	Film resistor, 5%	0402	Yageo	RC0402FR-0710RL
7	R8, R10, R11, R12, R13, R23, R24	10	Film resistor, 1%	0603	Yageo	RC0603FR-0710RL
1	U1		Step-down converter	FC-QFN	MPS	MPQ4436GR
1	JP1		Connector, 2x20, 2.54mm, right angle		Any	
5	VIN, VEMI GND, VOUT, GND	Test point	2.0 golden pin		HZ	
8	SS, SYNCIN, FB, ICS, PG, SYNCO, EN, GND	Test point	1.0 golden pin		HZ	

EVB TEST RESULTS

Performance curves and waveforms are tested on the evaluation board. $V_{IN} = 12V$, $V_{OUT} = 3.3V$, $L = 4.7\mu H$, $f_{SW} = 470kHz$, $T_A = 25^\circ C$, unless otherwise noted.

Efficiency vs. Load Current
AAM

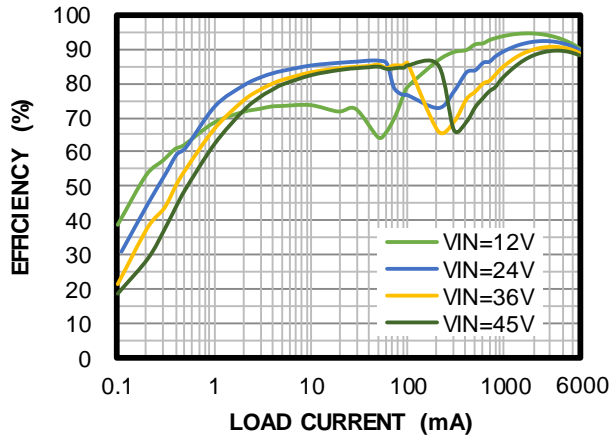

Efficiency vs. Load Current
CCM

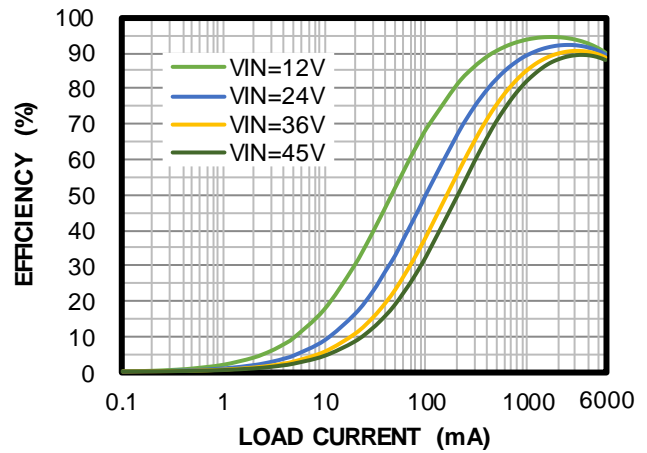

Efficiency vs. Load Current
(Extreme light load) AAM

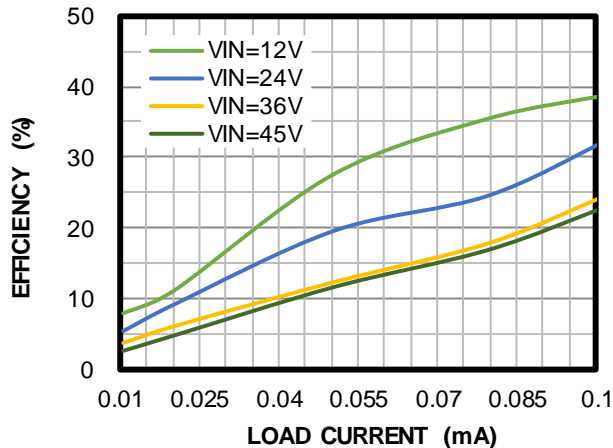

Efficiency vs. Load Current
(Extreme light load) CCM

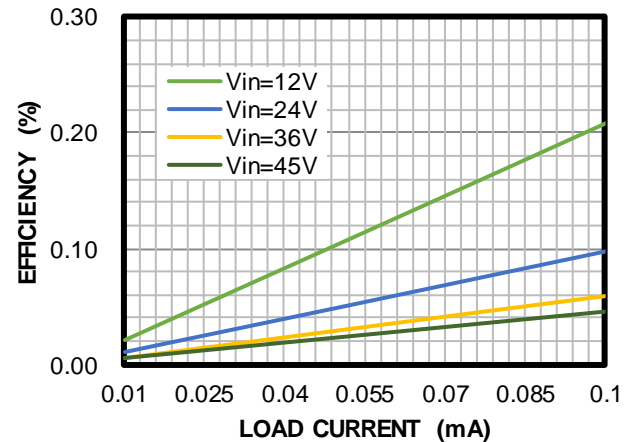

EVB TEST RESULTS (continued)

Performance curves and waveforms are tested on the evaluation board. $V_{IN} = 12V$, $V_{OUT} = 3.3V$, $L = 4.7\mu H$, $f_{SW} = 470kHz$, AAM, $T_A = 25^\circ C$, unless otherwise noted.

Steady State

$I_{OUT} = 0A$, AAM

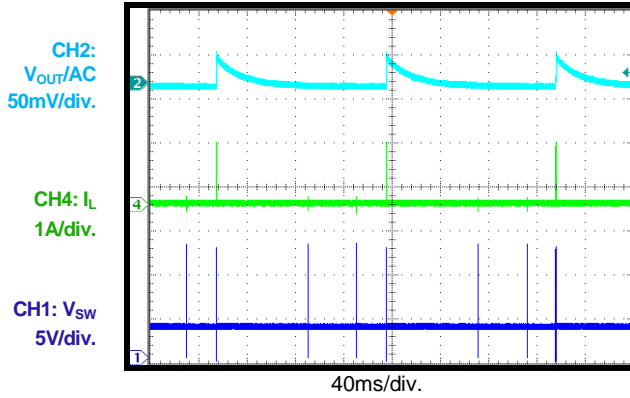

Steady State

$I_{OUT} = 0A$, FCCM

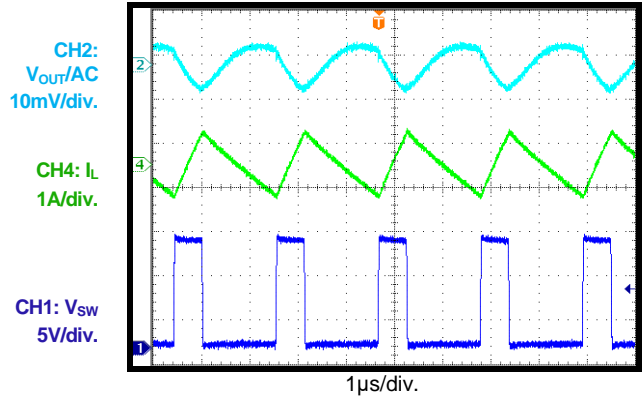

Steady State

$I_{OUT} = 6A$

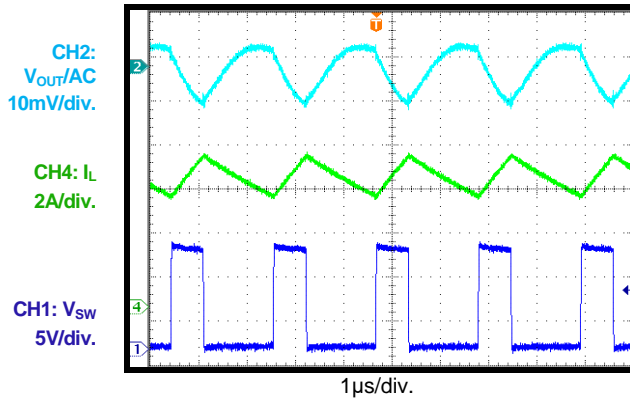

Start-Up through V_{IN}

$I_{OUT} = 0A$, AAM

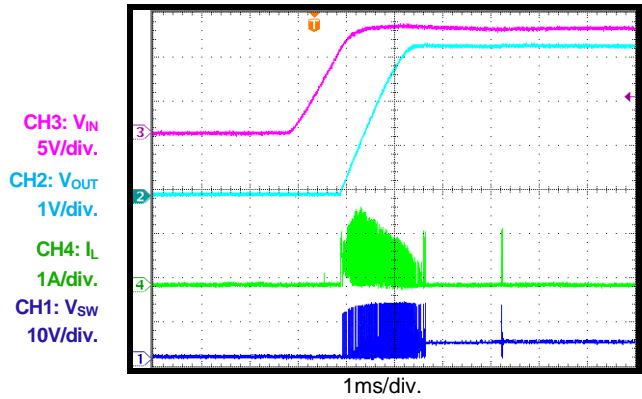

Start-Up through V_{IN}

$I_{OUT} = 0A$, FCCM

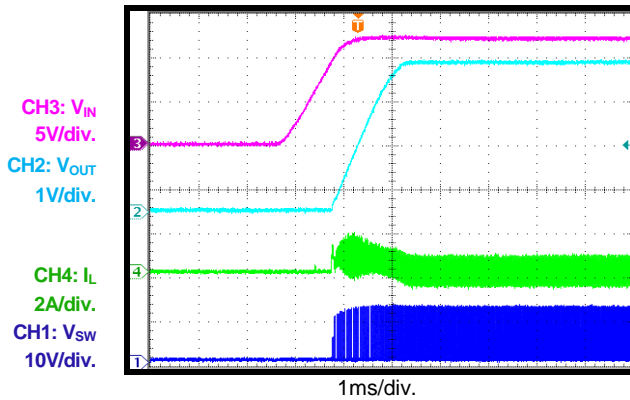

Start-Up through V_{IN}

$I_{OUT} = 6A$

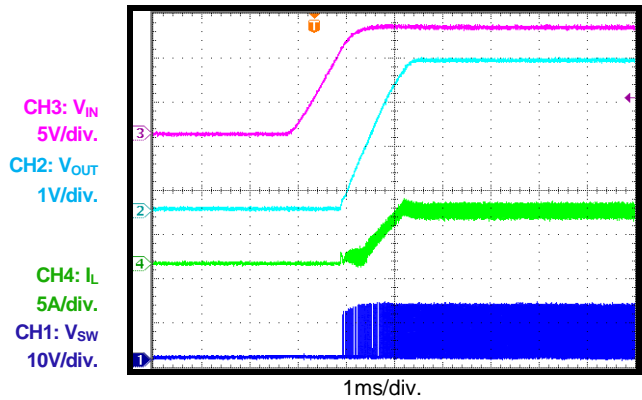

EVB TEST RESULTS (continued)

Performance curves and waveforms are tested on the evaluation board. $V_{IN} = 12V$, $V_{OUT} = 3.3V$, $L = 4.7\mu H$, $f_{SW} = 470kHz$, AAM, $T_A = 25^\circ C$, unless otherwise noted.

Shutdown through V_{IN}

$I_{OUT} = 0A$, AAM

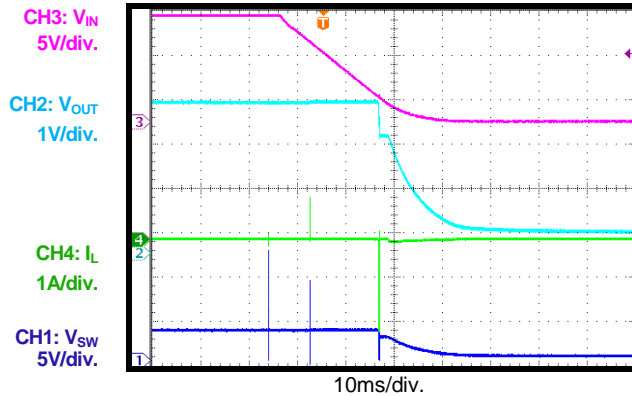

Shutdown through V_{IN}

$I_{OUT} = 0A$, FCCM

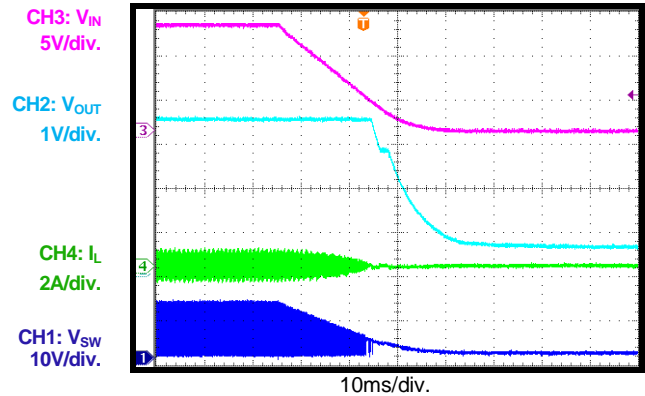

Shutdown through V_{IN}

$I_{OUT} = 6A$

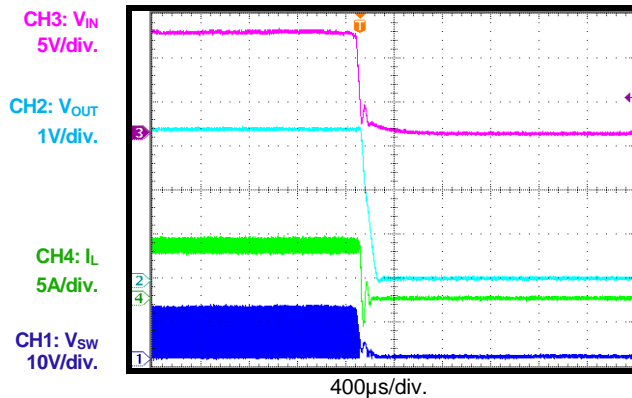

Start-Up through EN

$I_{OUT} = 0A$, AAM

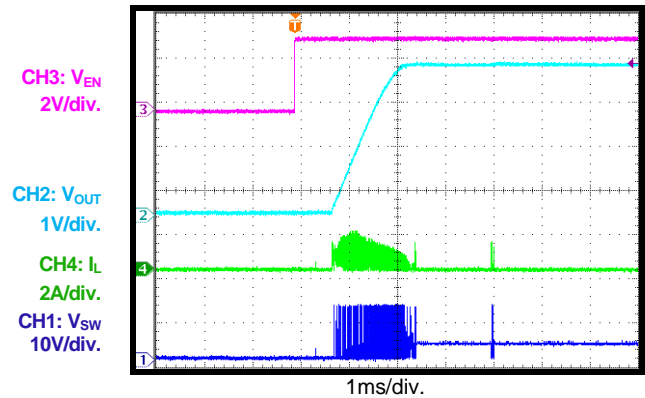

Start-Up through EN

$I_{OUT} = 0A$, FCCM

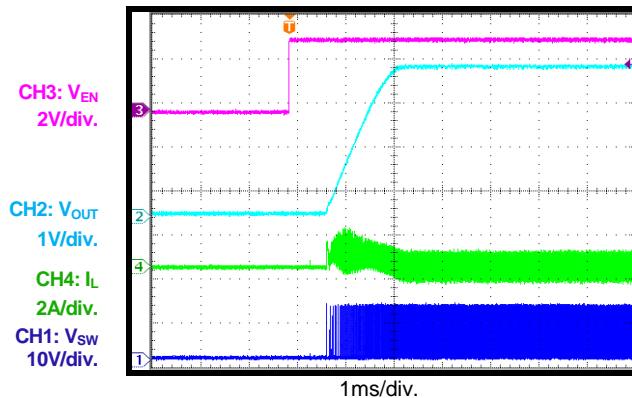

Start-Up through EN

$I_{OUT} = 6A$

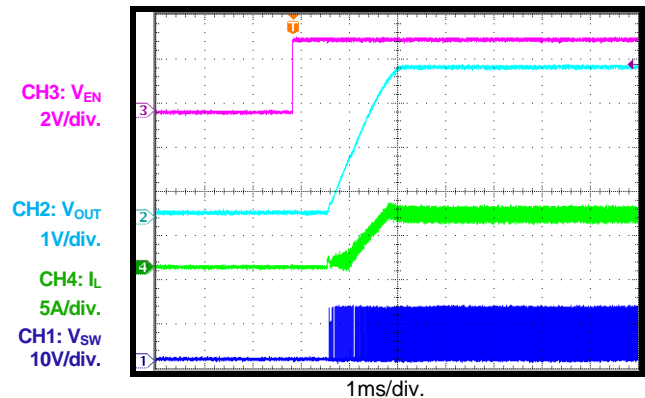

EVB TEST RESULTS (continued)

Performance curves and waveforms are tested on the evaluation board. $V_{IN} = 12V$, $V_{OUT} = 3.3V$, $L = 4.7\mu H$, $f_{SW} = 470kHz$, AAM, $T_A = 25^\circ C$, unless otherwise noted.

Shutdown through EN

$I_{OUT} = 0A$, AAM

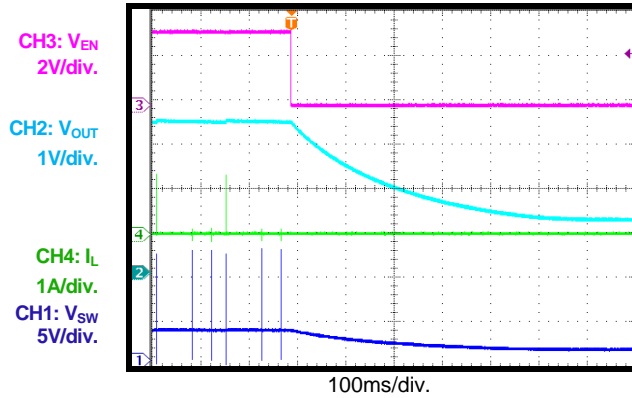

Shutdown through EN

$I_{OUT} = 0A$, FCCM

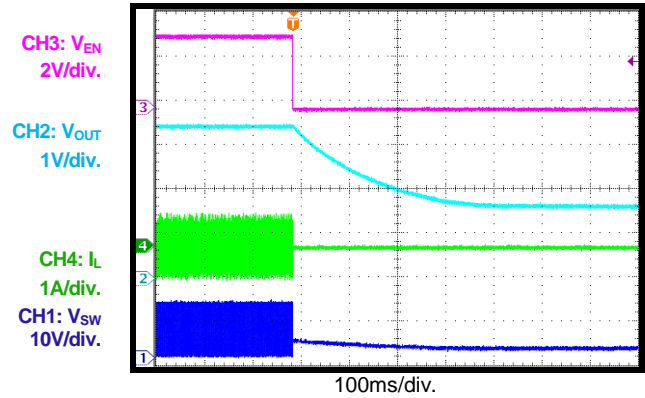

Shutdown through EN

$I_{OUT} = 6A$

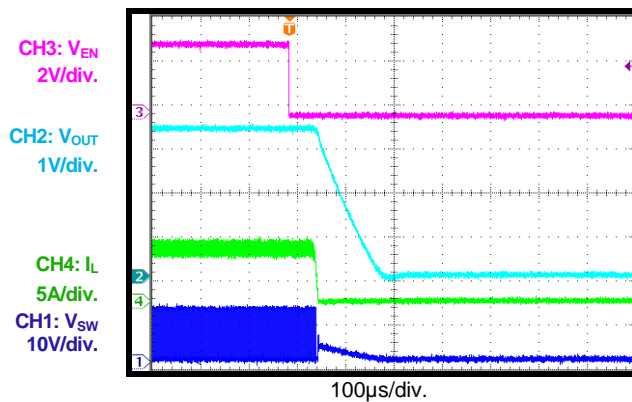

SCP Entry

$I_{OUT} = 0A$, AAM

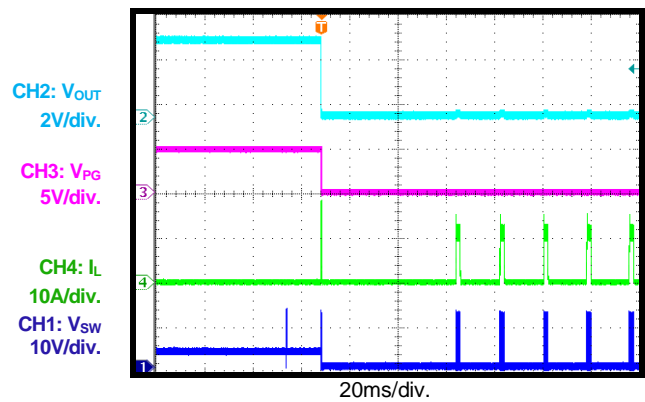

SCP Entry

$I_{OUT} = 0A$, FCCM

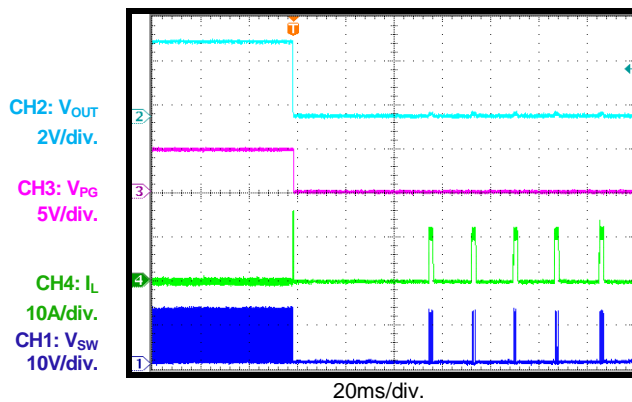

SCP Entry

$I_{OUT} = 6A$

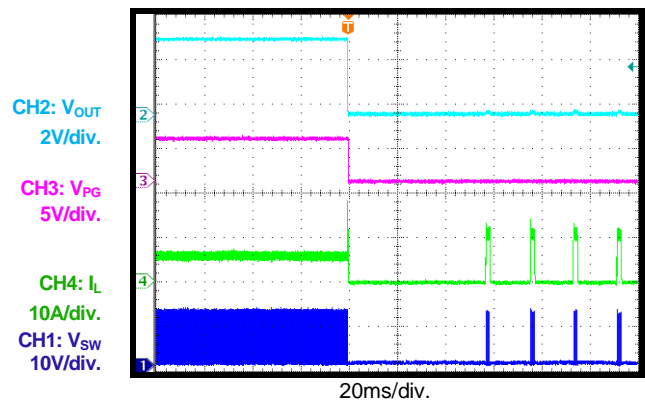

EVB TEST RESULTS (continued)

Performance curves and waveforms are tested on the evaluation board. $V_{IN} = 12V$, $V_{OUT} = 3.3V$, $L = 4.7\mu H$, $f_{SW} = 470kHz$, AAM, $T_A = 25^\circ C$, unless otherwise noted.

SCP Recovery

$I_{OUT} = 0A$, AAM

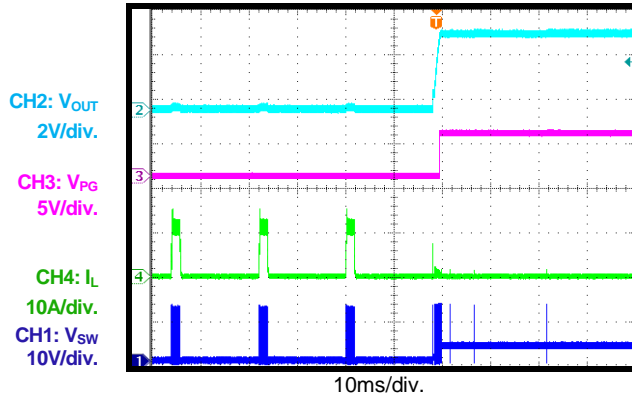

SCP Recovery

$I_{OUT} = 0A$, FCCM

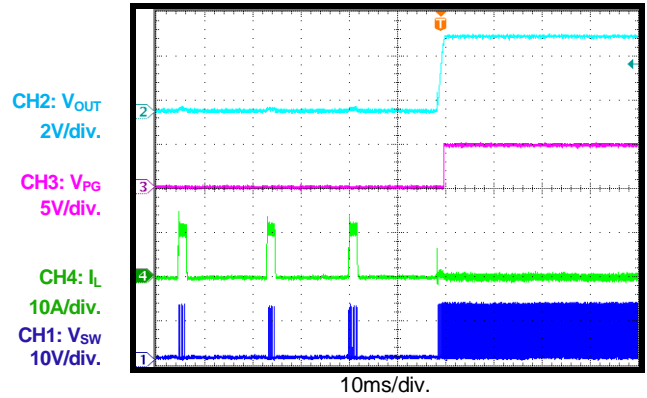

SCP Recovery

$I_{OUT} = 6A$

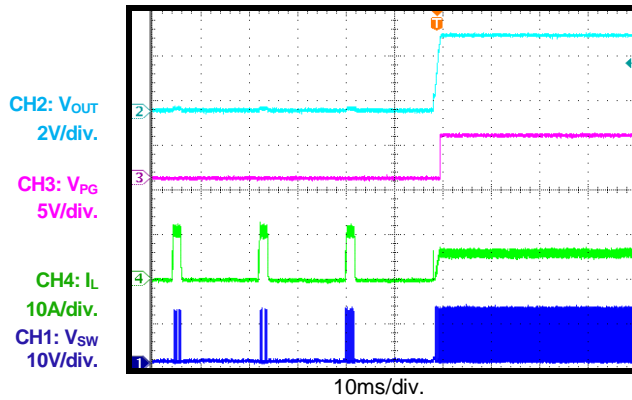

SCP Steady State

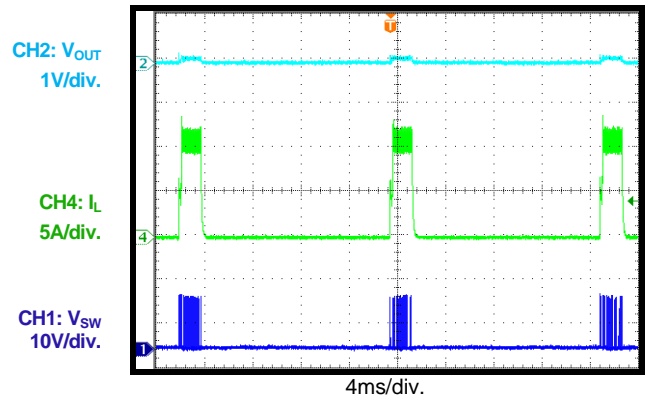

Load Transient

$I_{OUT} = 3A$ to $6A$, $1.6A/\mu s$

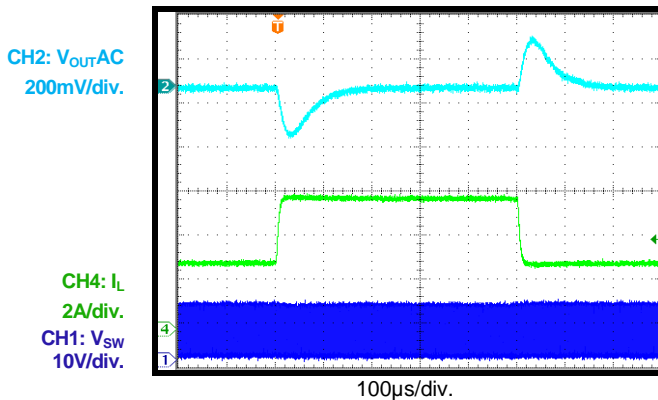

SYNC Operation

$I_{OUT} = 6A$, SYNC frequency = $350kHz$

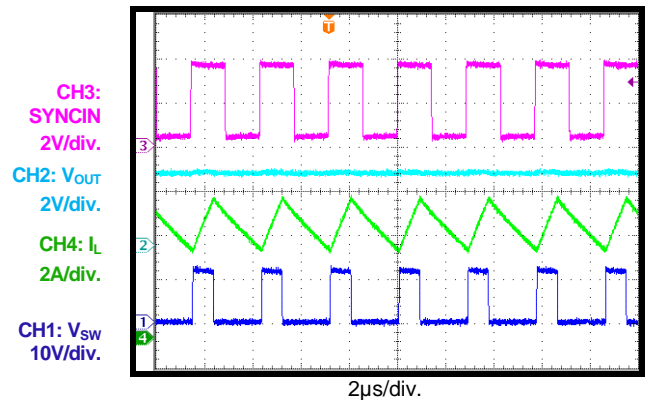

EVB TEST RESULTS (continued)

Performance curves and waveforms are tested on the evaluation board. $V_{IN} = 12V$, $V_{OUT} = 3.3V$, $L = 4.7\mu H$, $f_{SW} = 470kHz$, AAM, $T_A = 25^\circ C$, unless otherwise noted.

SYNC Operation

$I_{OUT} = 6A$, SYNC frequency = 530kHz

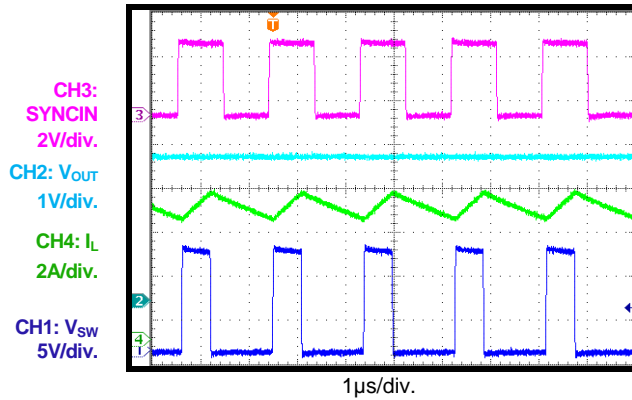

SYNCO Operation

$I_{OUT} = 6A$, SYNC frequency = 350kHz

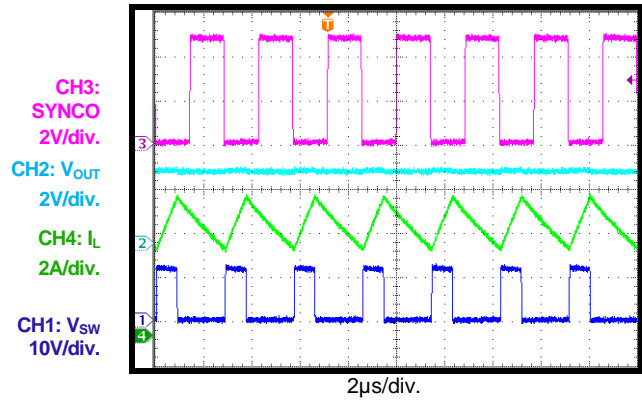

SYNCO Operation

$I_{OUT} = 6A$, SYNC frequency = 530kHz

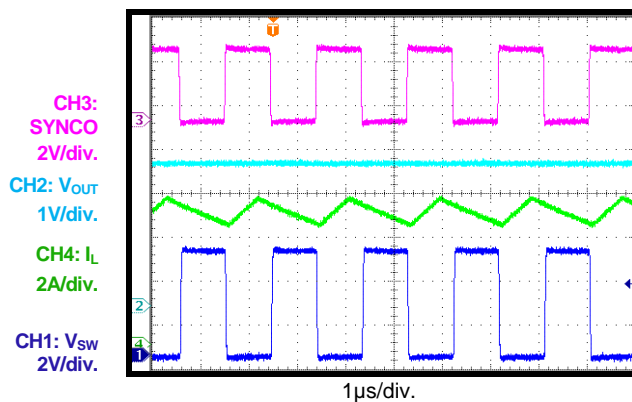

PG Start-Up through V_{IN}

$I_{OUT} = 0A$

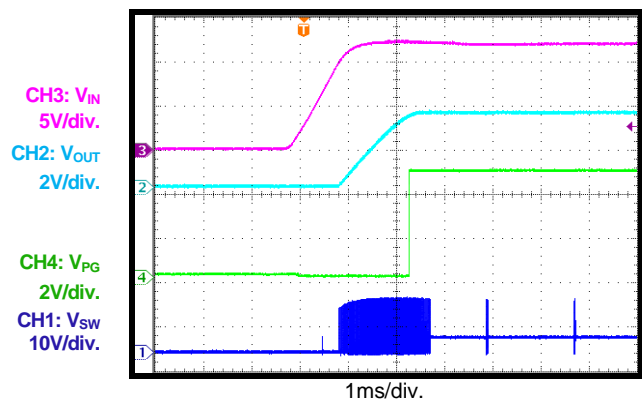

PG Start-Up through V_{IN}

$I_{OUT} = 6A$

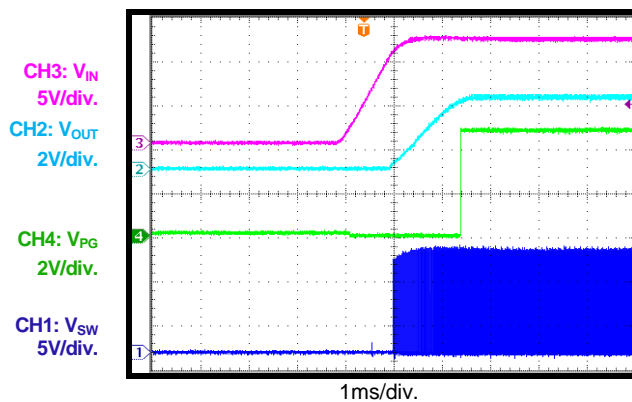

PG Shutdown through V_{IN}

$I_{OUT} = 0A$

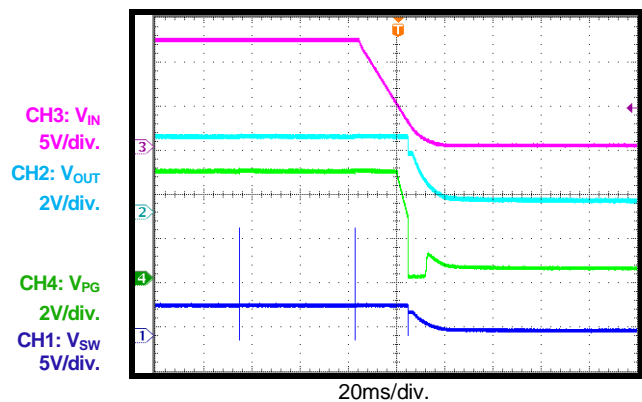

EVB TEST RESULTS (continued)

Performance curves and waveforms are tested on the evaluation board. $V_{IN} = 12V$, $V_{OUT} = 3.3V$, $L = 4.7\mu H$, $f_{SW} = 470kHz$, AAM, $T_A = 25^\circ C$, unless otherwise noted.

PG Shutdown through V_{IN}

$I_{OUT} = 6A$

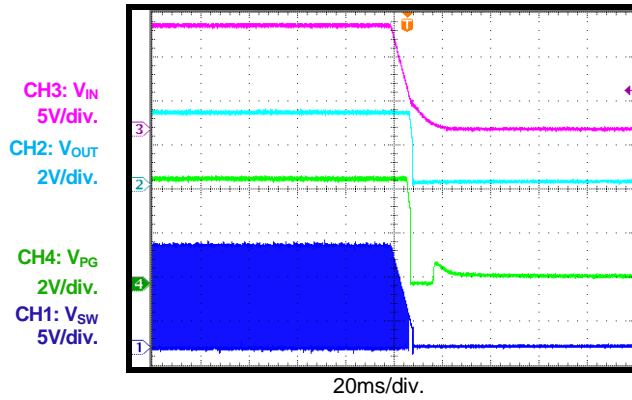

PG Start-Up through EN

$I_{OUT} = 0A$

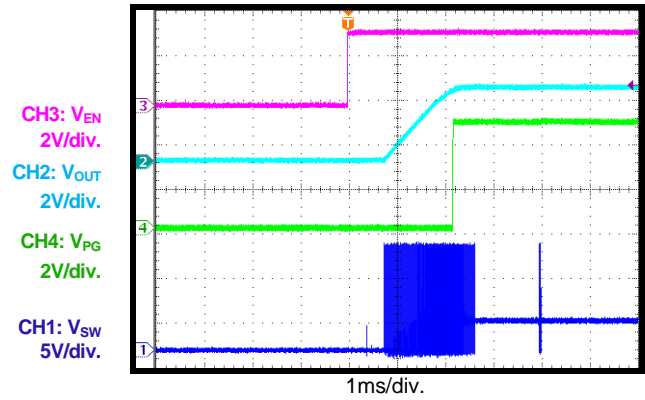

PG Start-Up through EN

$I_{OUT} = 6A$

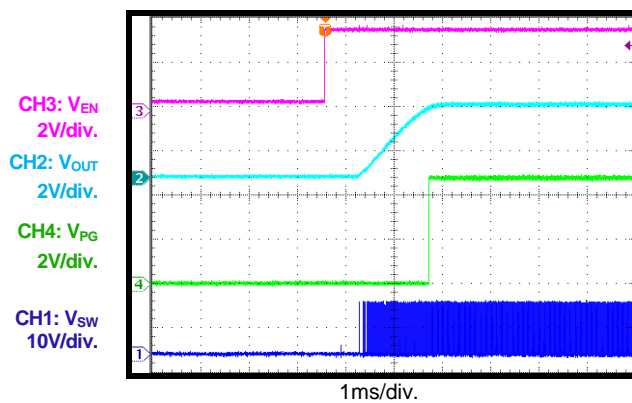

PG Shutdown through EN

$I_{OUT} = 0A$

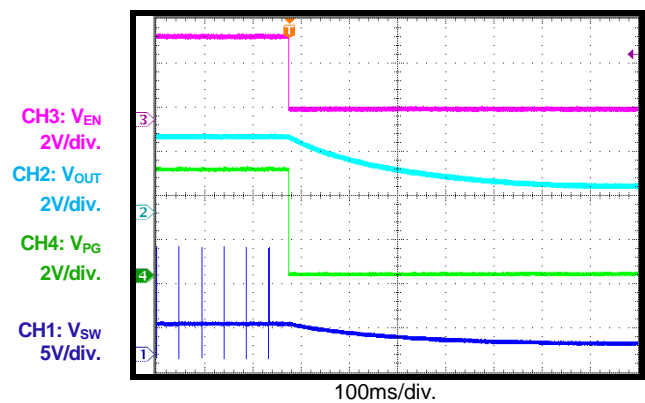

PG Shutdown through EN

$I_{OUT} = 6A$

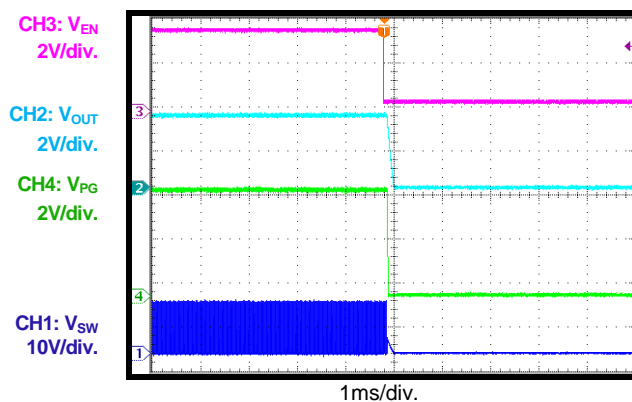

Dropout Operation

$V_{IN} = 3.3V$, V_{OUT} set to 3.3V, $I_{OUT} = 0A$

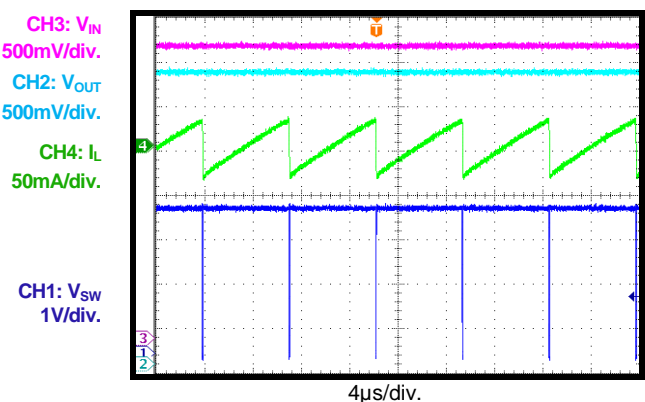

EVB TEST RESULTS (continued)

Performance curves and waveforms are tested on the evaluation board. $V_{IN} = 12V$, $V_{OUT} = 3.3V$, $L = 4.7\mu H$, $f_{SW} = 470kHz$, AAM, $T_A = 25^\circ C$, unless otherwise noted.

Dropout Operation

$V_{IN} = 3.3V$, V_{OUT} set to 3.3V, $I_{OUT} = 6A$

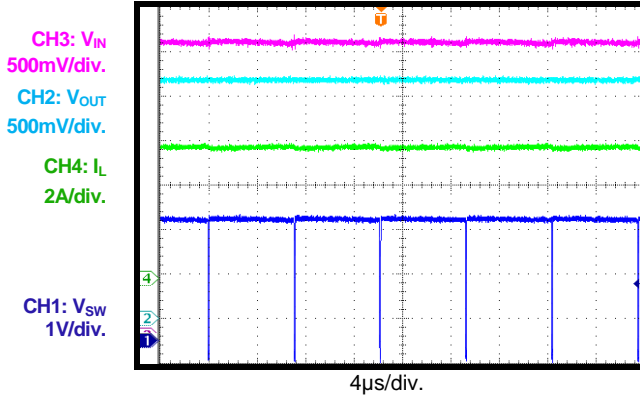

Load Dump

$V_{IN} = 12V$ to 36V, $I_{OUT} = 6A$

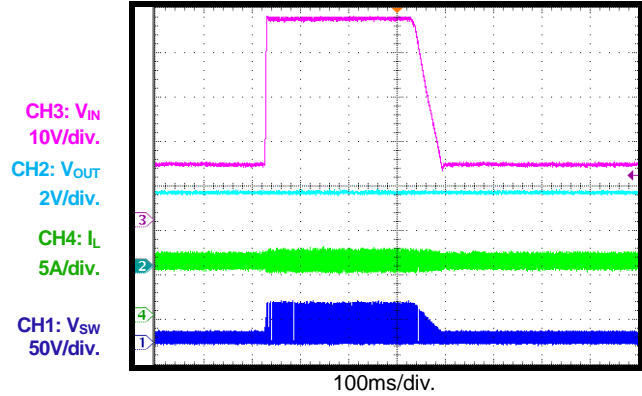

Cold Crank

$V_{IN} = 12V$ to 3.3V to 5V, $I_{OUT} = 6A$

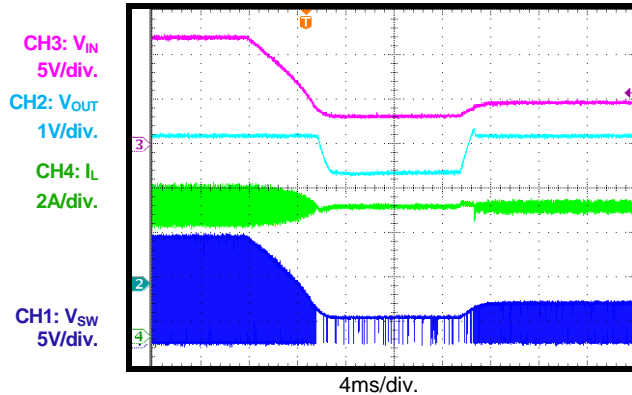

V_{IN} Ramp Up and Down

$I_{OUT} = 0.1A$

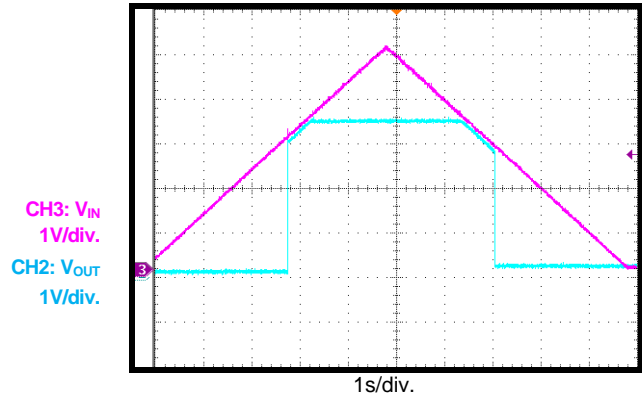

V_{IN} Ramp Down and Up

$I_{OUT} = 1mA$

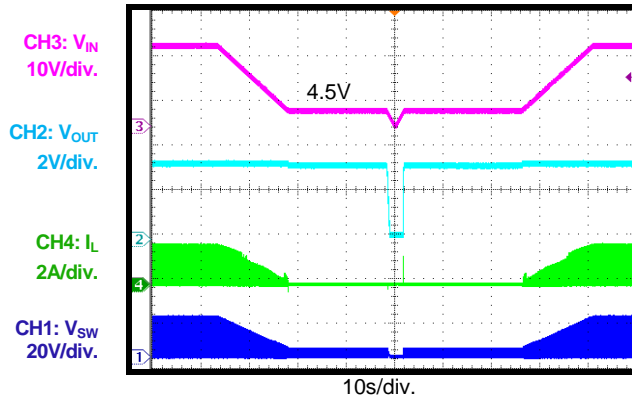

V_{IN} Ramp Down and Up

$I_{OUT} = 6A$

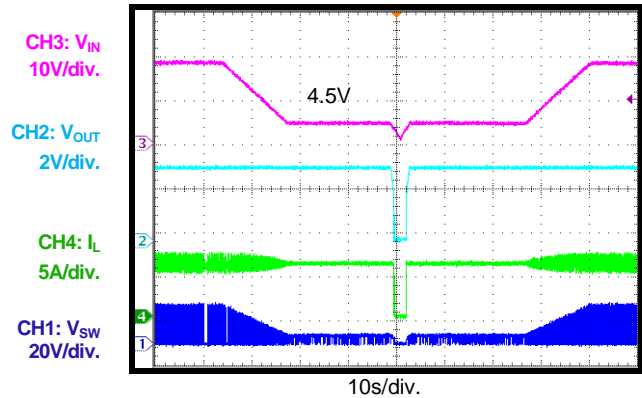

PCB LAYOUT

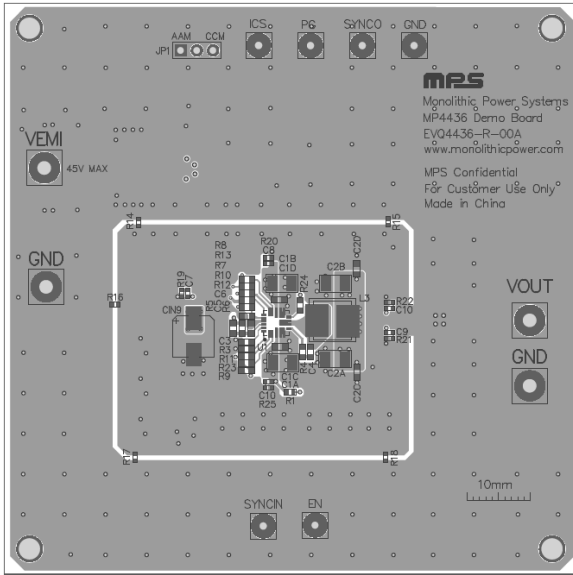

Figure 1: Top Silk Layer and Top Layer

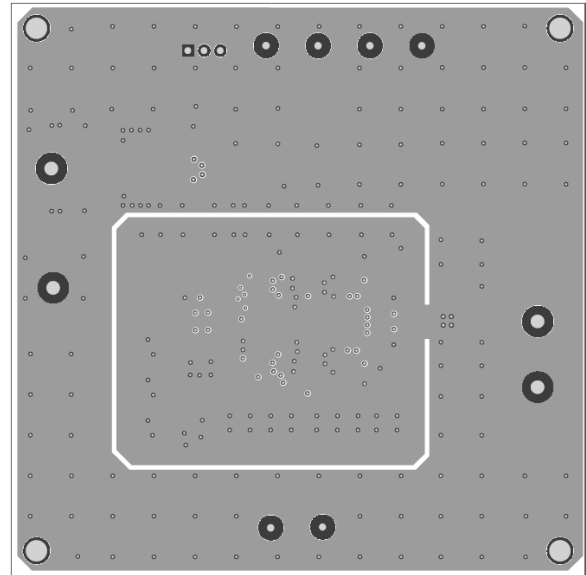

Figure 3: Inner Layer 1

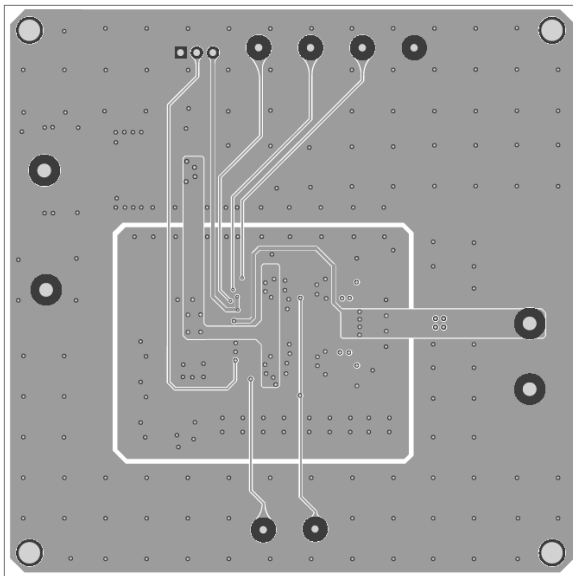

Figure 2: Inner Layer 2

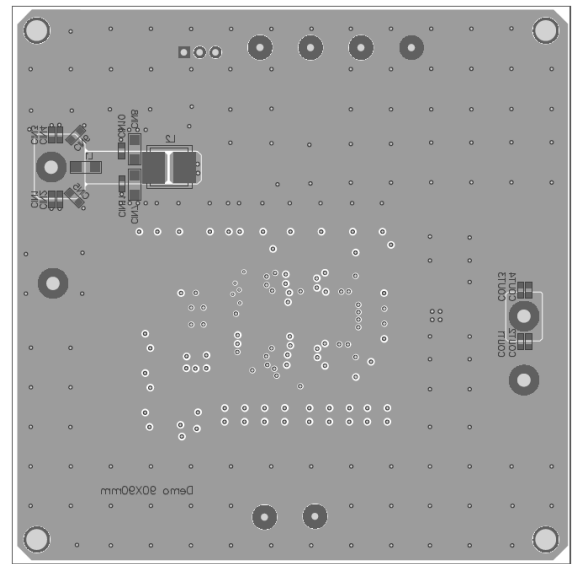

Figure 2: Bottom Silk Layer and Bottom Layer

Notice: The information in this document is subject to change without notice. Please contact MPS for current specifications. Users should warrant and guarantee that third-party Intellectual Property rights are not infringed upon when integrating MPS products into any application. MPS will not assume any legal responsibility for any said applications.