



EVQ4425A-QB-00A

High Efficiency 1.5A, 36V, 2.2MHz
Synchronous Step-Down LED Driver Evaluation Board

DESCRIPTION

The EVQ4425A-QB-00A is an evaluation board for the MPQ4425A-AEC1 and MPQ4425A.

MPQ4425A-AEC1/MPQ4425A is a high-efficiency, synchronous, rectified, step-down, switch-mode white LED driver with built-in power MOSFETs. It offers a very compact solution to achieve a 1.5A continuous output current with excellent load and line regulation over a wide input supply range. The MPQ4425A has synchronous mode operation to get high efficiency.

The EVQ4425A-QB-00A is a fully assembled and tested evaluation board, which generates load current up to 1.5A from a 4V to 36V input range.

ELECTRICAL SPECIFICATION

Parameter	Symbol	Value	Units
Input Voltage	V_{EMI}	4 - 36	V
Output Current	I_{LED}	1.5	A

FEATURES

- Wide 4V to 36V Operating Input Range
85mΩ High-Side, 50mΩ Low-Side Internal Power MOSFETs
- High-Efficiency Synchronous Mode Operation
- Default 2.2MHz Switching Frequency
- PWM Dimming (Min 100Hz Dimming Frequency)
- Force CCM Mode
- 0.2V Reference Voltage
- Internal Soft-Start
- Fault Indication for LED Short, Open and Thermal Shutdown
- Over-Current Protection (OCP) with Valley-Current Detection
- Proprietary Switching-Loss-Reduction Technology
- Thermal Shutdown
- Available in a QFN-13 (2.5mmx3mm) Package
- CISPR25 Class5 Compliant
- AEC-Q100 Grade-1

APPLICATIONS

- Automotive LED Lighting

All MPS parts are lead-free, halogen free, and adhere to the RoHS directive. For MPS green status, please visit MPS website under Quality Assurance. "MPS" and "The Future of Analog IC Technology" are Registered Trademarks of Monolithic Power Systems, Inc.

EVQ4425A-QB-00A EVALUATION BOARD

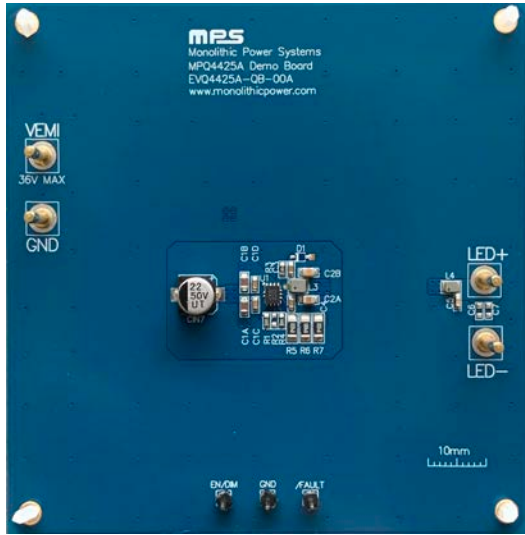

(L x W x H) 6.35cm x 6.35cm x 1.3cm

Board Number	MPS IC Number
EVQ4425A-QB-00A	MPQ4425AGQB-AEC1

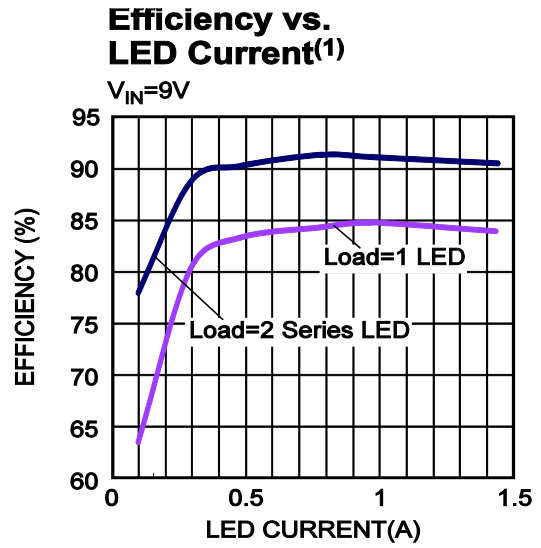

QUICK START GUIDE

1. Connect the positive and negative terminals of the LED to the LED+ and LED- pins, respectively.
2. Preset the power supply output to between 4 and 36V, and then turn it off.
If longer cables are used between the source and the EVB (>0.5m total), a damping capacitor should be installed at the input terminals. Especially when V_{in} is $\geq 24V$.
3. Connect the positive and negative terminals of the power supply output to the VIN and GND pins, respectively. To get better EMI performance, connect the input power between VEMI and GND.
4. Turn the power supply on. The MPQ4425AGQB will automatically startup.
5. To use the Enable function, apply a digital input to the EN pin. Drive EN higher than 1.45V to turn on the regulator, drive EN less than 1V to turn it off.
6. To use the Dimming function, apply a 100Hz to 2kHz external clock to the EN/DIM pin for the PWM dimming.
7. The output current is set by the external resistor R_{FB} , Feedback reference voltage is 0.2V, I_{LED} is then given by below equation:

$$I_{LED} = \frac{0.2V}{R_{FB}}$$

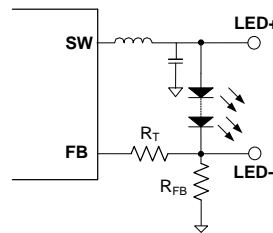
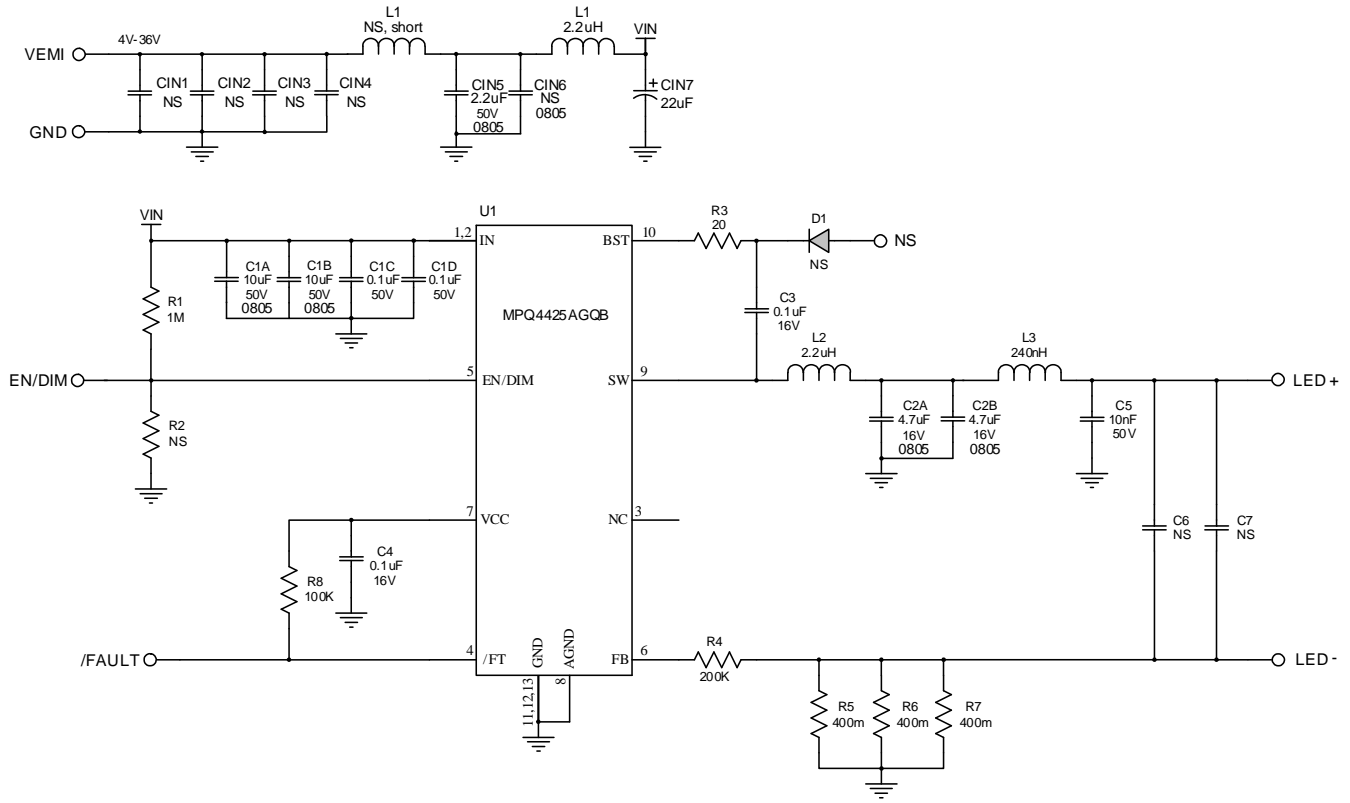

Figure 1: Feedback Network

8. R_T is used to set the loop bandwidth. Basically, lower R_T , higher bandwidth. But high bandwidth may cause insufficient phase margin, resulting in loop unstable. So a proper value of R_T is needed to make a trade-off between bandwidth and phase margin. Below table lists the recommended feedback resistor and R_T values for common output with 1 or 2 series LED.

I_{LED} (A)	R_{FB} (m Ω)	R_T (k Ω)
0.5	400(1%)	200 (1%)
1	200(1%)	150 (1%)
1.5	133(1%)	100 (1%)

EVALUATION BOARD SCHEMATIC



Package Reference

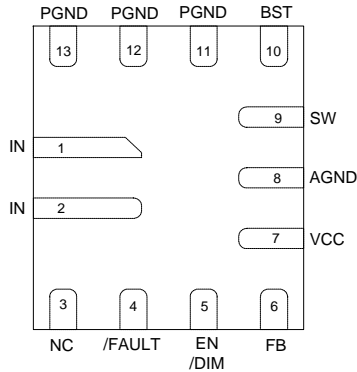

EVQ4425A-QB-00A BILL OF MATERIALS

Qty	Designator	Value	Description	Package	Manufacture	Manufacturer_PN
1	CIN5	2.2uF	Ceramic Capacitor, 50V, X7R	0805	TDK	C2012X7R1H225K
1	CIN7	22uF	Electrolytic Capacitor, 50V	SMD	Cotronic	UT1H220M0605VG
2	C1A, C1B	4.7uF	Ceramic Capacitor, 50V, X7S	0805	Murata	GRM21BC71H475KE11L
2	C1C, C1D	0.1uF	Ceramic Capacitor, 50V, X7R	0603	Murata	GRM188R71H104KA93D
2	C2A, C2B	4.7uF	Ceramic Capacitor, 16V, X7R	0805	Murata	GCM21BR71C475KA73L
2	C3, C4	0.1uF	Ceramic Capacitor, 25V, X7R	0603	Murata	GCJ188R71E104KA12D
1	C5	10nF	Ceramic Capacitor, 25V, X7R	0603	Würth	885012206065
7	CIN1, CIN2, CIN3, CIN4, CIN6, C6, C7	NS				
1	D1	NS				
1	L1	Short				
2	L2, L3	2.2uH	Inductor, 70mOhm DCR, 2.6A	SMD	Cyntec	VCUW25201B-2R2MS5
1	L4	240nH	Inductor, 27mOhm DCR, 6.5A	SMD	Cyntec	VCUW20161B-R24MS5
1	R1	1M	Film Resistor, 5%	0603	Yageo	RC0603JR-071ML
1	R3	20	Film Resistor, 1%	0603	Yageo	RC0603FR-0720RL
1	R4	200K	Film Resistor, 1%	0603	Yageo	RC0603FR-07200KL
3	R5, R6, R7	400m	Film Resistor, 1%	1206	Yageo	RL1206FR-070R4L
1	R8	100K	Film Resistor, 1%	0603	Yageo	RC0603FR-07100KL
1	R2	NS				
1	U1		Step-Down Regulator	QFN13 (2mmX3mm)	MPS	MPQ4425AGQB-AEC1
4	VEMI, GND, LED+, LED-		2.0mm Golden Pin		HZ	
3	EN/DIM, GND, /FAULT		2.54mm Test Pin		HZ	

EVB TEST RESULTS

Performance waveforms are tested on the evaluation board.

$V_{IN} = 12V$, $LOAD=2$ series LED, $L=2.2\mu H$, $F_{SW}=2.2MHz$, $T_A = +25^{\circ}C$, unless otherwise noted.

CISPR25 CLASS 5 PEAK CONDUCTED EMISSIONS

150kHz to 108MHz

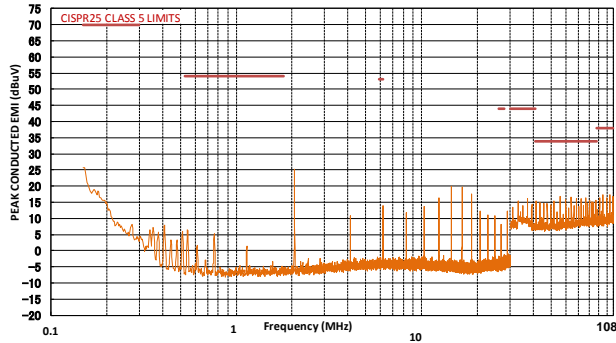

CISPR25 CLASS 5 AVERAGE CONDUCTED EMISSIONS

150kHz to 108MHz

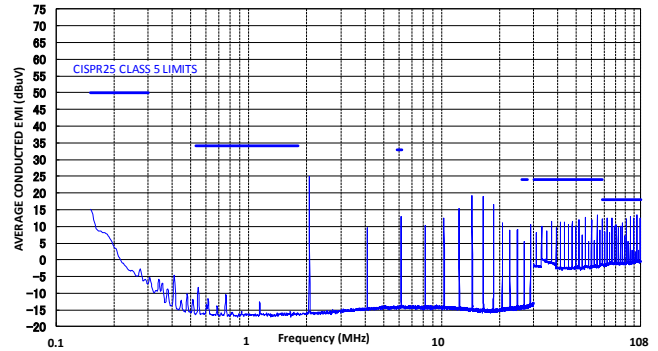

CISPR25 CLASS 5 PEAK RADIATED EMISSIONS

150kHz to 30MHz

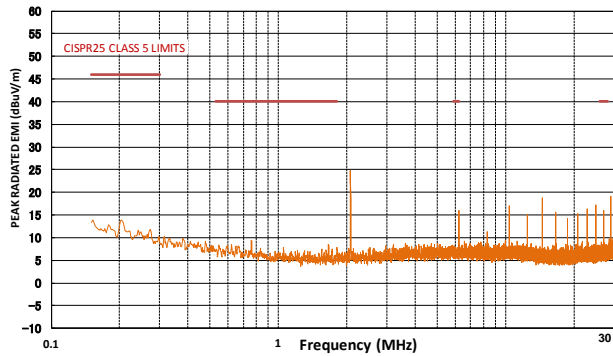

CISPR25 CLASS 5 AVERAGE RADIATED EMISSIONS

150kHz to 30MHz

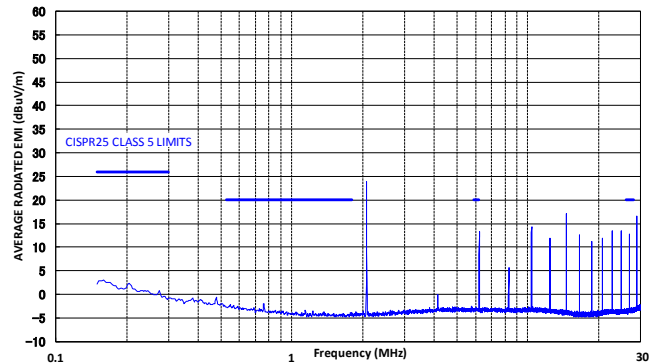

CISPR25 CLASS 5 PEAK RADIATED EMISSIONS

Horizontal, 30MHz to 200MHz

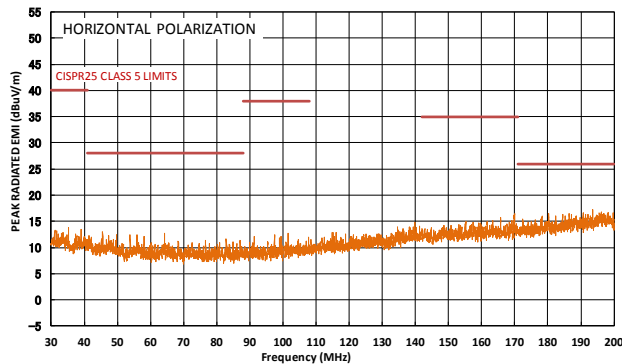

CISPR25 CLASS 5 AVERAGE RADIATED EMISSIONS

Horizontal, 30MHz to 200MHz

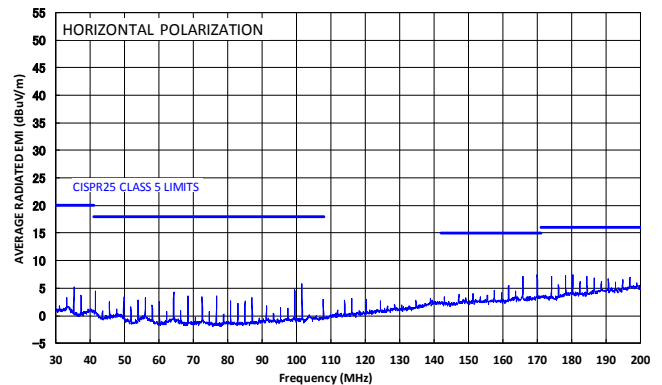

EVB TEST RESULTS *(continued)*

Performance waveforms are tested on the evaluation board.

$V_{IN} = 12V$, $LOAD=2$ series LED, $L=2.2\mu H$, $F_{SW}=2.2MHz$, $T_A = +25^\circ C$, unless otherwise noted.

CISPR25 CLASS 5 PEAK RADIATED EMISSIONS

Vertical, 30MHz to 200MHz

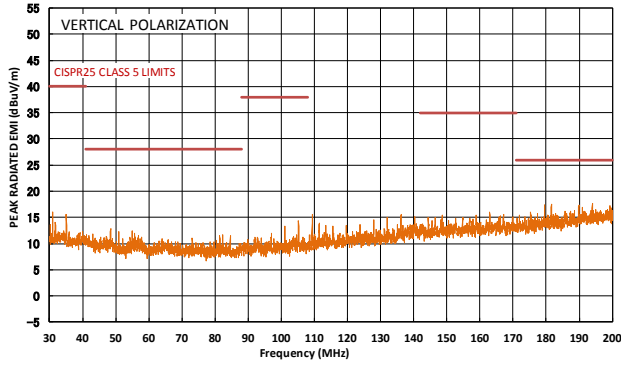

CISPR25 CLASS 5 AVERAGE RADIATED EMISSIONS

Vertical, 30MHz to 200MHz

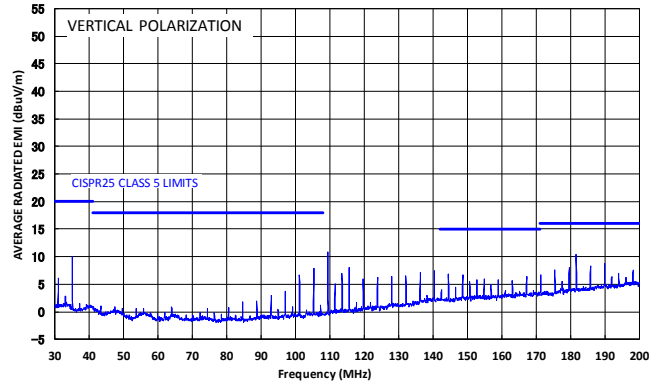

CISPR25 CLASS 5 PEAK RADIATED EMISSIONS

Horizontal, 200MHz to 1GHz

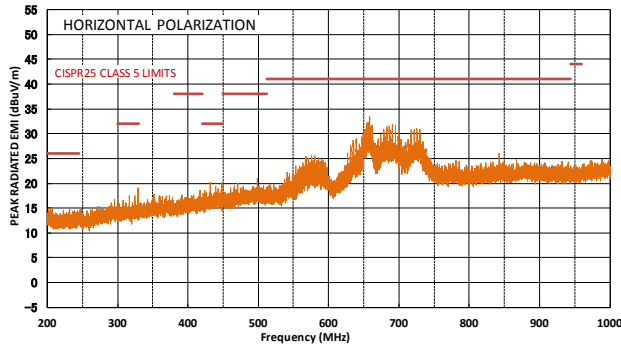

CISPR25 CLASS 5 AVERAGE RADIATED EMISSIONS

Horizontal, 200MHz to 1GHz

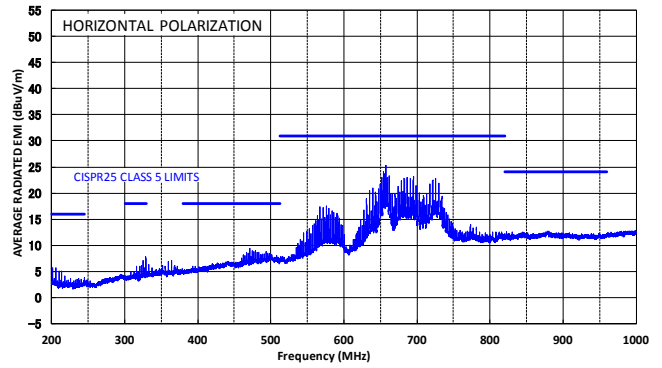

CISPR25 CLASS 5 PEAK RADIATED EMISSIONS

Vertical, 200MHz to 1GHz

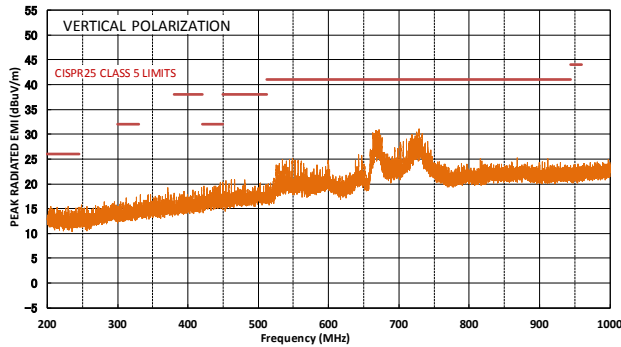

CISPR25 CLASS 5 AVERAGE RADIATED EMISSIONS

Vertical, 200MHz to 1GHz

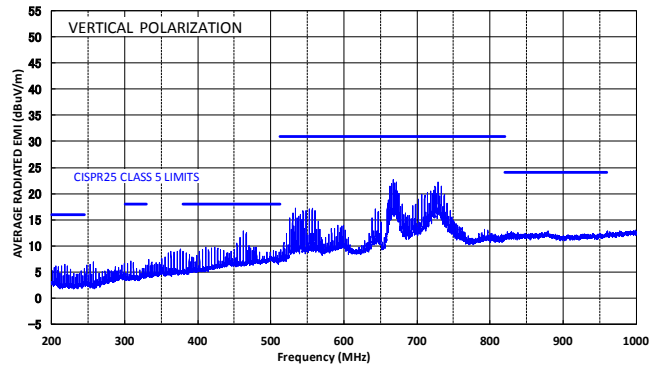

EVB TEST RESULTS *(continued)*

Performance waveforms are tested on the evaluation board.

$V_{IN} = 12V$, LOAD=2 series LED, $L=2.2\mu H$, $F_{SW}=2.2MHz$, $T_A = +25^\circ C$, unless otherwise noted.⁽¹⁾

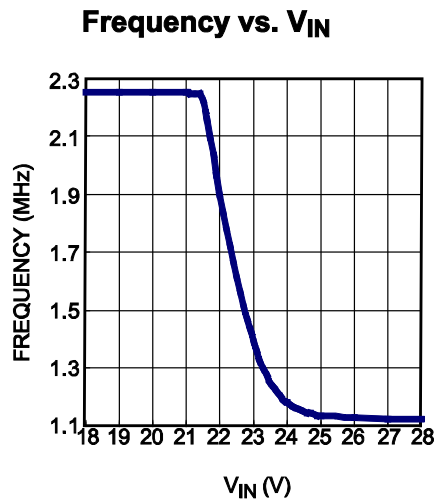
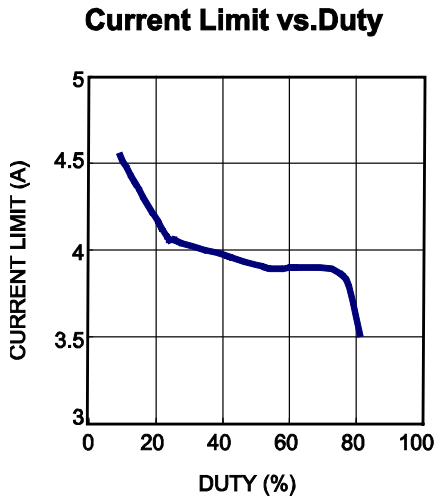
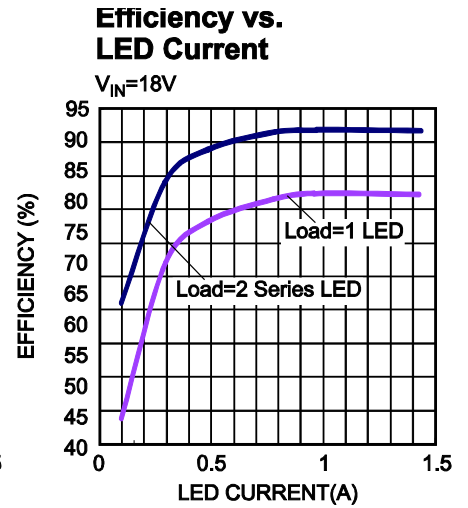
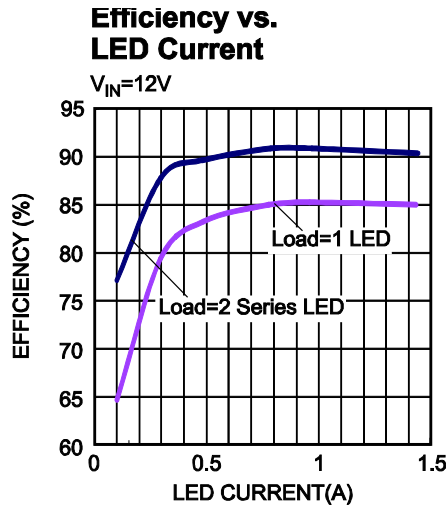
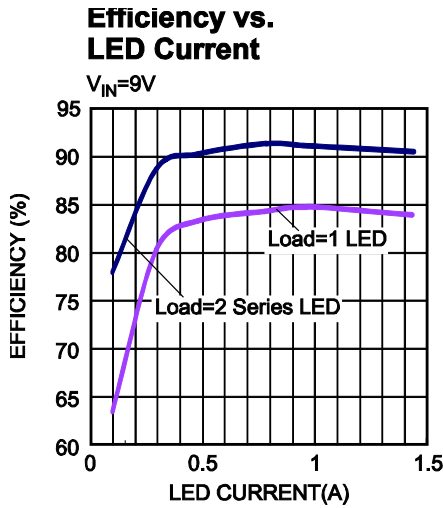

Note:

1). All the efficiency curves are tested on EVB without input and output filters.

EVB TEST RESULTS *(continued)*

Performance waveforms are tested on the evaluation board.

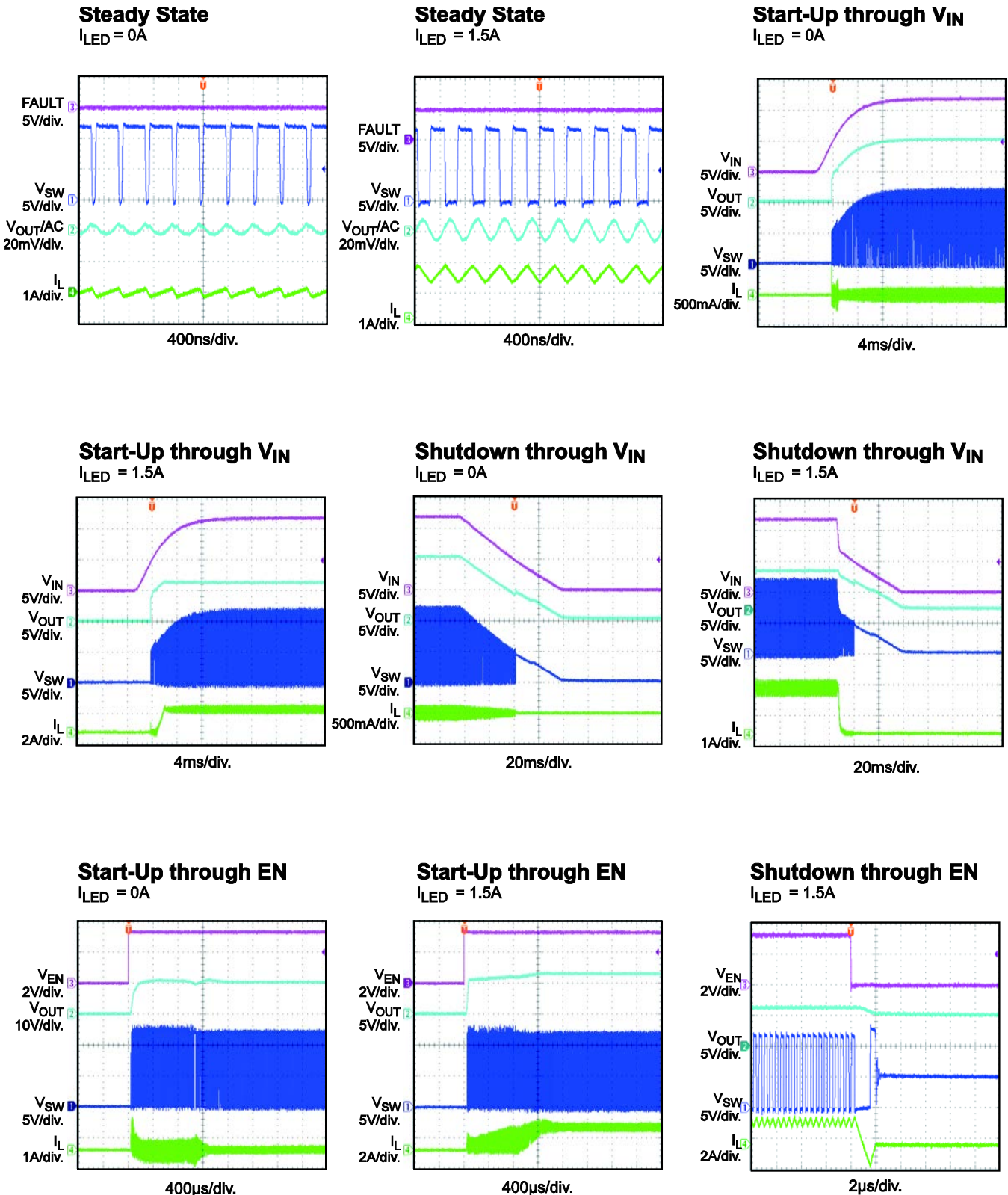
 $V_{IN} = 12V$, LOAD=2 series LED, $L=2.2\mu H$, $F_{SW}=2.2MHz$, $T_A = +25^\circ C$, unless otherwise noted.

EVB TEST RESULTS *(continued)*

Performance waveforms are tested on the evaluation board.

$V_{IN} = 12V$, LOAD=2 series LED, $L=2.2\mu H$, $F_{SW}=2.2MHz$, $T_A = +25^\circ C$, unless otherwise noted.

PWM Dimming
400Hz

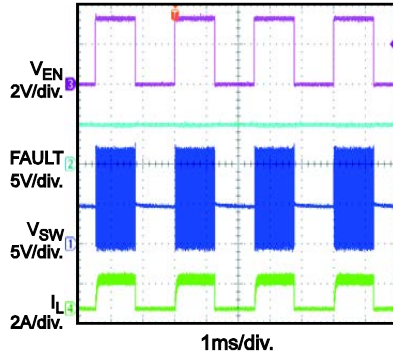

PWM Dimming
2kHz

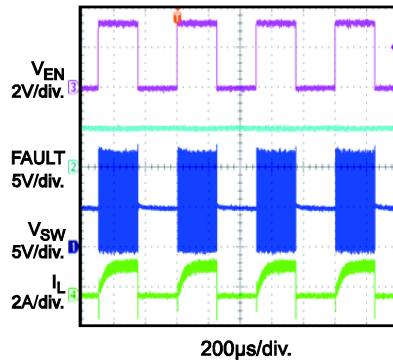

LED+ Short to GND
Steady State

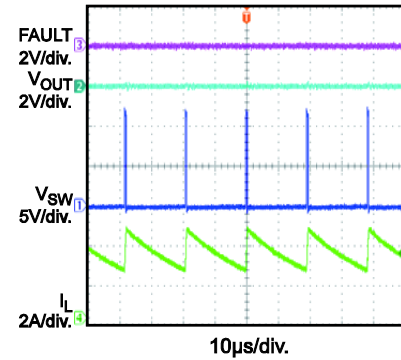

LED+ Short to GND Entry
 $I_{LED} = 0A$

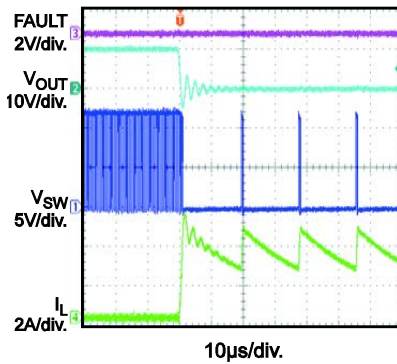

LED+ Short to GND Entry
 $I_{LED} = 1.5A$

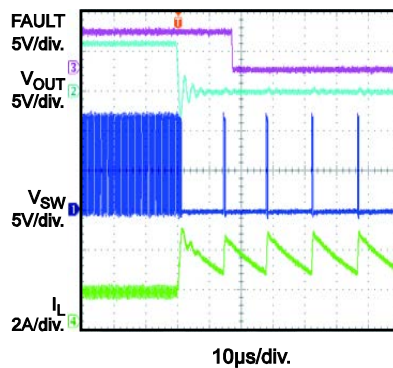

LED+ Short to GND Recovery
 $I_{LED} = 0A$

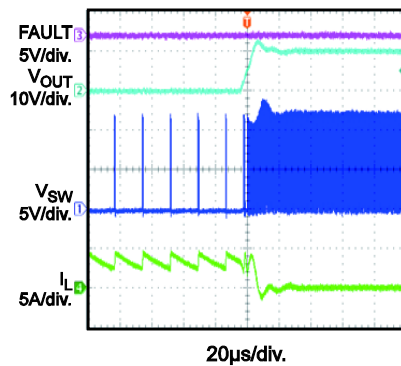

LED+ Short to GND Recovery
 $I_{LED} = 1.5A$

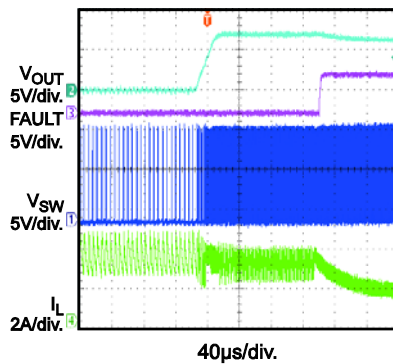

LED+ Short to GND
Input Power On

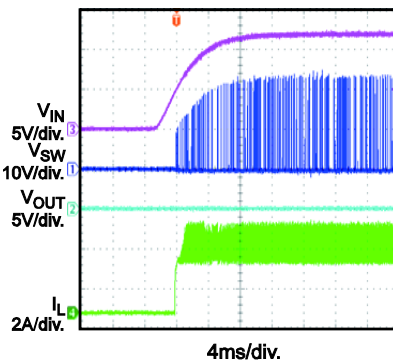

LED+ Short to GND
Input Power Off

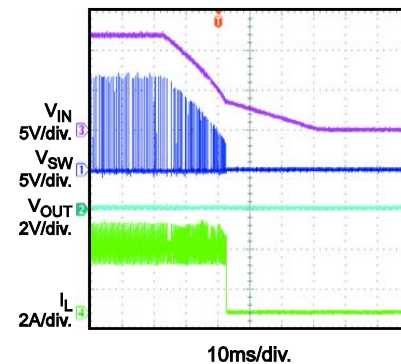

EVB TEST RESULTS *(continued)*

Performance waveforms are tested on the evaluation board.

$V_{IN} = 12V$, $LOAD=2$ series LED, $L=2.2\mu H$, $F_{SW}=2.2MHz$, $T_A = +25^\circ C$, unless otherwise noted.

LED+ Short to GND EN On

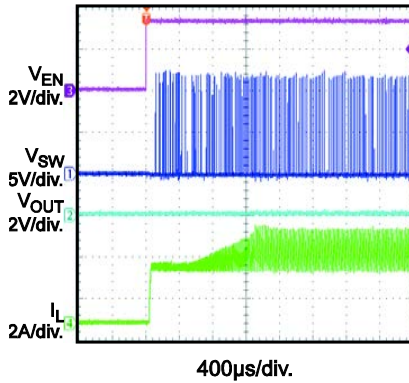

LED+ Short to GND EN Off

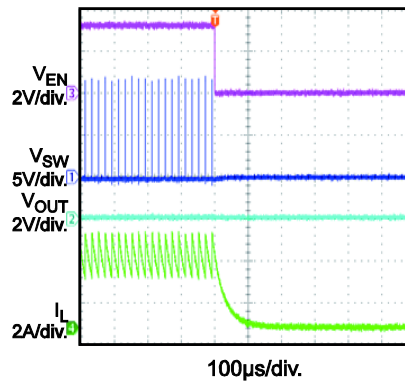

LED Open Entry

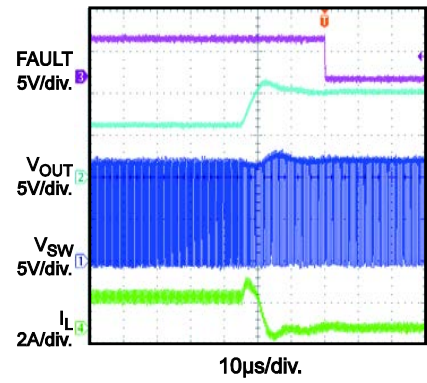

LED Open Recovery

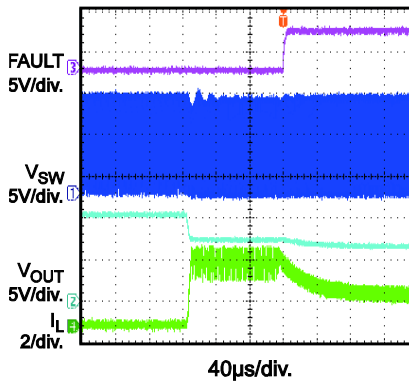

LED+ and LED- Short Entry

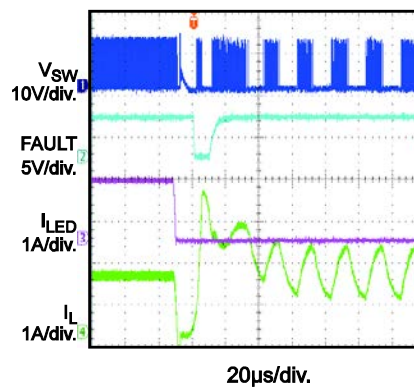

LED+ and LED- Short Recovery

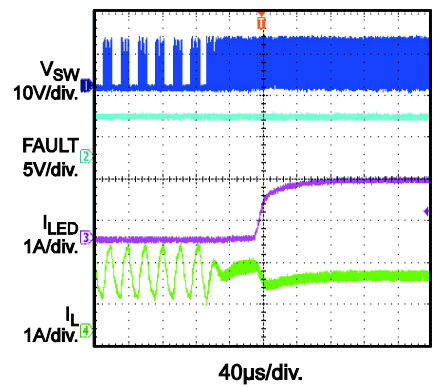

PRINTED CIRCUIT BOARD LAYOUT

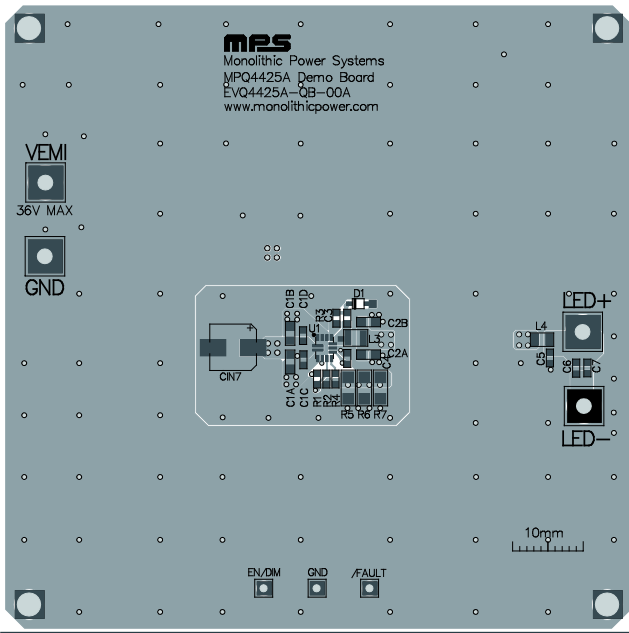

Figure 2: Top Silk and Top Layer

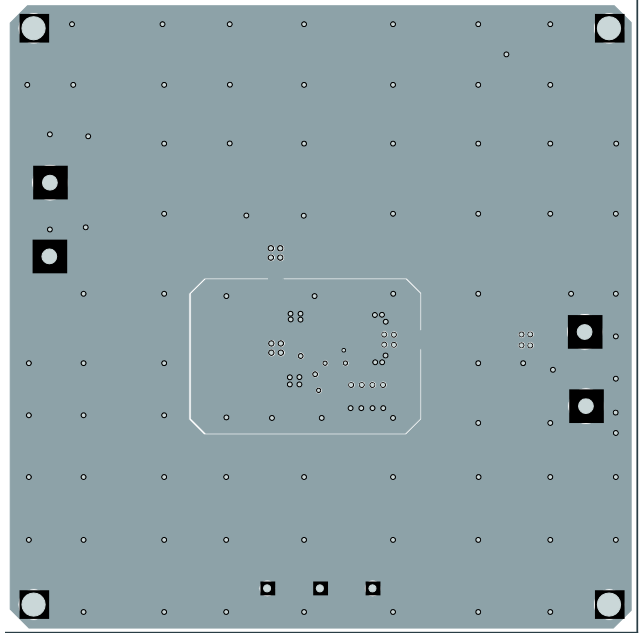

Figure 3: Inner1 Layer

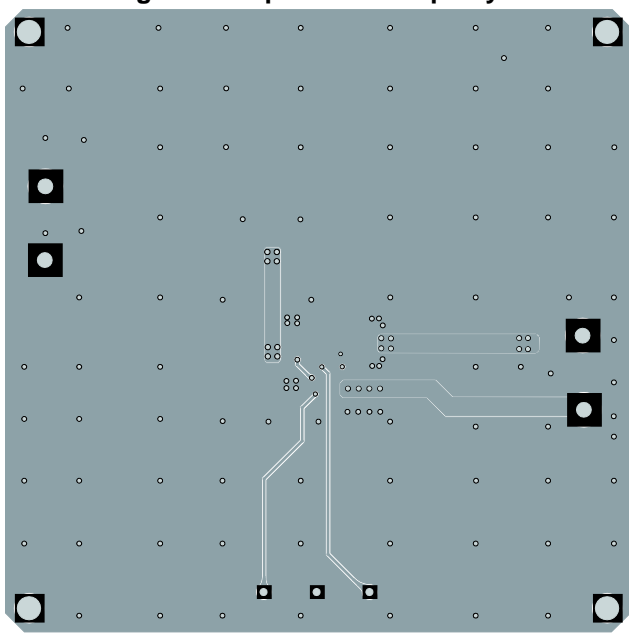

Figure 4: Inner2 Layer

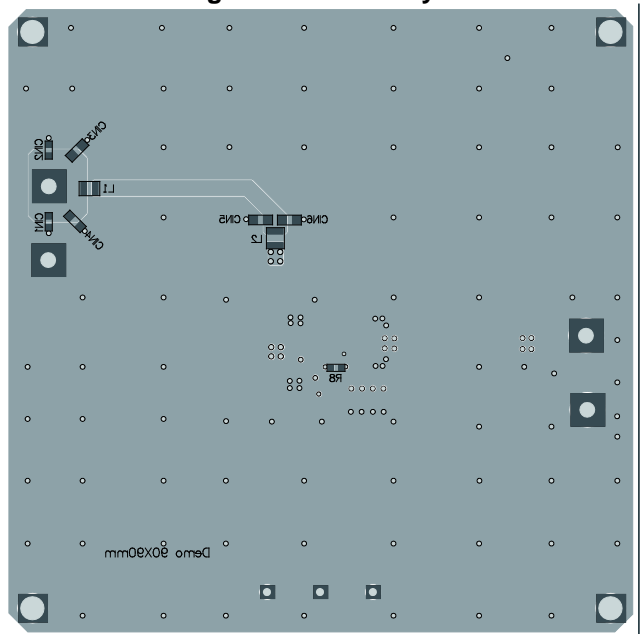

Figure 5: Bottom Silk and Bottom Layer

NOTICE: The information in this document is subject to change without notice. Please contact MPS for current specifications. Users should warrant and guarantee that third party Intellectual Property rights are not infringed upon when integrating MPS products into any application. MPS will not assume any legal responsibility for any said applications.