



The Future of Analog IC Technology®

# EVQ2451-G-00A

## 0.6A, 2MHz, 36V Step-Down Converter Evaluation Board

### DESCRIPTION

The EVQ2451-G-00A is an evaluation board for the MPQ2451, a fixed 2MHz frequency step-down switching regulator with an integrated internal high-side high voltage power MOSFET. The IC provides 0.6A output with current mode control for fast loop response and easy compensation.

High power conversion efficiency over a wide load range is achieved by scaling down the switching frequency at light load condition to reduce the switching and gate driving losses.

The soft-start function helps prevent inductor current runaway during startup and thermal shutdown provides reliable, fault tolerant operation.

By switching at 2MHz, smaller value inductor and input/output capacitor can be used to lower down cost and save board space.

### ELECTRICAL SPECIFICATIONS

Parameter	Symbol	Value	Units
Input Voltage	$V_{IN}$	8-36	V
Output Voltage	$V_{OUT}$	5	V
Output Current	$I_{OUT}$	0-0.6	A

### FEATURES

- Wide Operating Input Range
- Fixed 2MHz Switching Frequency
- 0.6A Output Current
- Up to 90% Efficiency

### APPLICATIONS

- High Voltage Power Conversion
- Automotive Systems
- Industrial Power Systems
- Distributed Power Systems
- Battery Powered Systems

All MPS parts are lead-free and adhere to the RoHS directive. For MPS green status, please visit MPS website under Products, Quality Assurance page.

"MPS" and "The Future of Analog IC Technology" are Registered Trademarks of Monolithic Power Systems, Inc.

### EVQ2451-G-00A EVALUATION BOARD



(L x W x H) 1.8" x 1.8" x 0.4"  
4.6cm x 4.6cm x 1.0cm

Board Number	MPS IC Number
EVQ2451-G-00A	MPQ2451-G

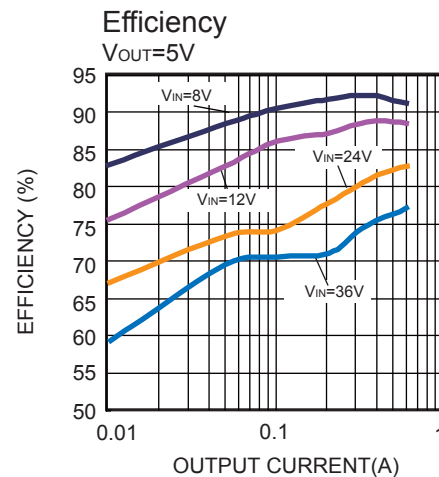

## EVALUATION BOARD SCHEMATIC

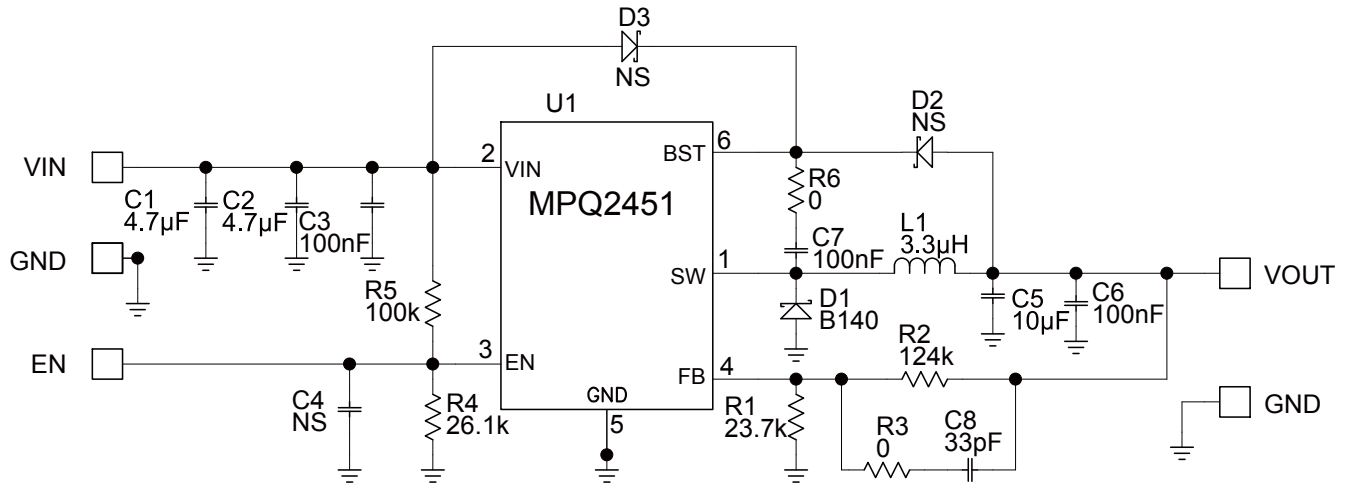

## EVQ2451-G-00A BILL OF MATERIALS

Qty	Ref	Value	Description	Package	Manufacturer	Manufacturer P/N
2	C1, C2	4.7 $\mu$ F	Ceramic Cap., 50V, 10%, X7R	1210	muRata	GRM32ER71H475KA88L
3	C3, C6, C7	0.1 $\mu$ F	Ceramic Cap., 50V, 10%, X7R	0603	muRata	GCJ188R71H104KA12D
2	C4, C8	NS				
1	C5	10 $\mu$ F	Ceramic Cap., 16V, 10%, X7R	1206	muRata	GRM31CR71C106KAC7L
1	D1	B140	Schottky Rect., 40V, 1A	SMA	Diodes Inc	B140-13-LF
2	D2, D3	NS				
1	L1	3.3 $\mu$ H	Inductor, I <sub>dc</sub> =2.15A, R <sub>dc</sub> =30mohm	SMD 5x5mm	Würth	WE-744043003
1	R1	23.7K $\Omega$	Film Res., 1%	0603	Yageo	RC0603FR-0723K7KL
1	R2	124K $\Omega$	Film Res., 1%	0603	Yageo	RC0603FR-07124KL
1	R3	NS				
1	R4	26.1K $\Omega$	Film Res., 1%	0603	Yageo	RC0603FR-0726K1KL
1	R5	100K $\Omega$	Film Res., 1%	0603	Yageo	RC0603FR-07100KL
1	R6	0	Film Res., 5%	0603	Yageo	RC0603JR-070RL
1	U1	MPQ2451DQ	Power Led Driver	QFN6L-2X2mm	MPS	MPQ2451DQ
4	VIN, GND, VOUT, GND		Power Test Point	2.3mm	HZ	China market
1	EN, GND		3x2.54mm Test Point	3x2.54mm	Sullins	PCC03SAAN

## EVB TEST RESULTS

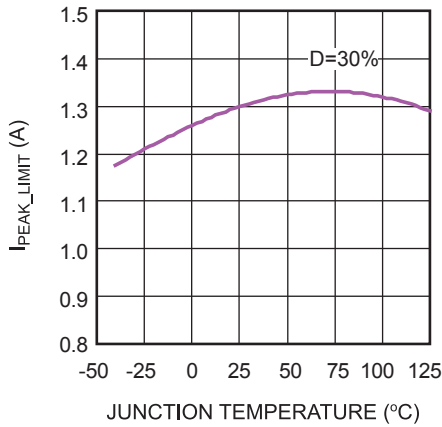
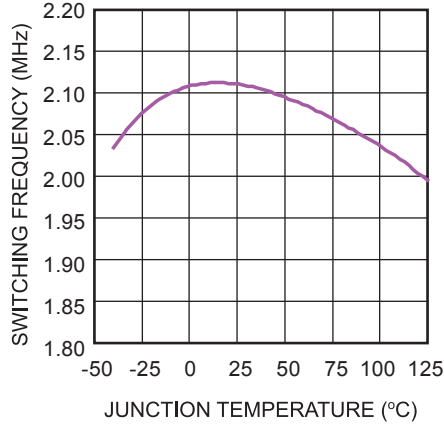
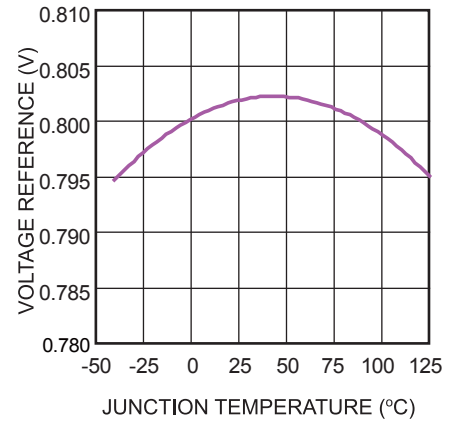
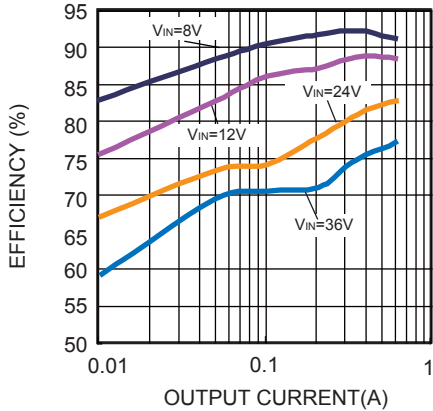
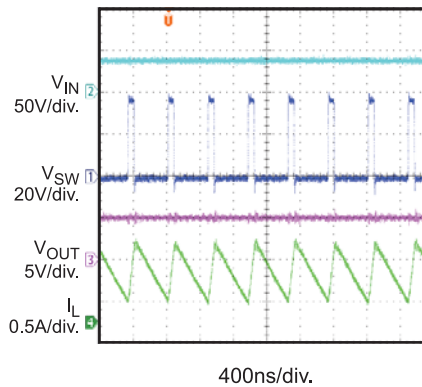
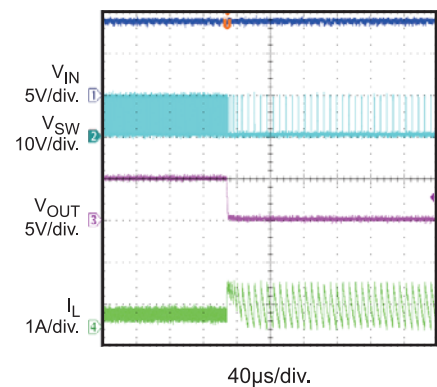
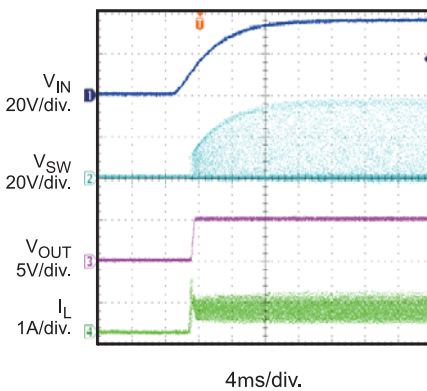
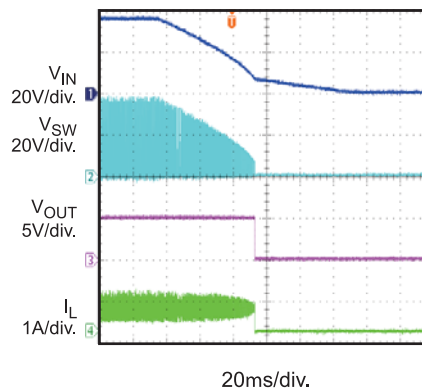
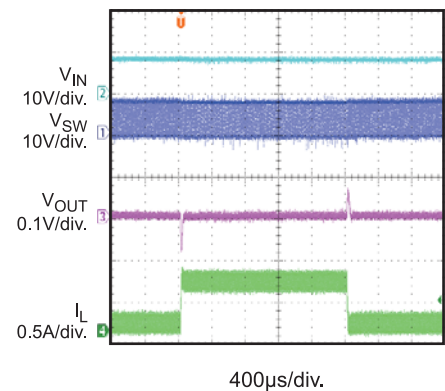
**Current Limit vs. Junction Temperature**

**Frequency vs. Junction Temperature**

**Voltage Reference vs. Junction Temperature**

**Efficiency**  
 $V_{OUT}=5V$ 

**Steady State**  
 $V_{IN} = 36V$ 

**Short Output**
 $V_{IN} = 8V, I_{OUT} = 0.5A$ 

**Power Ramp Up**
 $V_{IN} = 36V$ 

**Power Ramp Down**
 $V_{IN} = 36V$ 

**Load Transient**
 $V_{IN} = 8V, I_{OUT} = 0.1A - 0.6A$ 

### PRINTED CIRCUIT BOARD LAYOUT

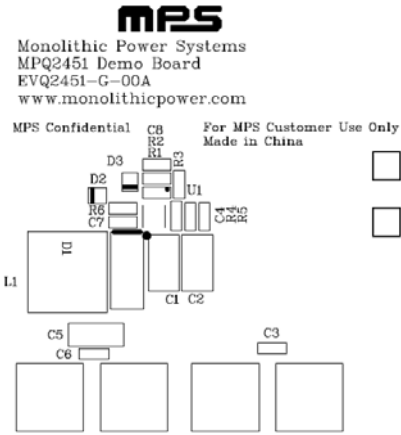

Figure 1—Top Silk Layer

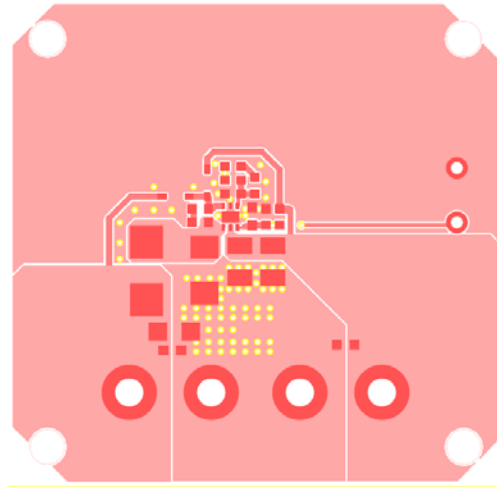

Figure 2—Top Layer

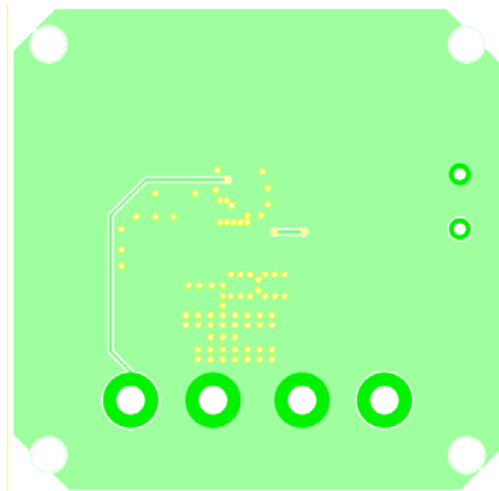

Figure 3—Bottom Layer

## QUICK START GUIDE

1. Connect the positive terminal of the load to VOUT pins, and the negative terminal of the load to GND pins.
2. Preset the power supply output to 12V and turn off the power supply.
3. Connect the positive terminal of the power supply output to the VIN pin and the negative terminal of the power supply output to the GND pin.
4. Turn on the power supply. The EVQ2451 will automatically start up.
5. To use the Enable function, apply a digital input to the EN pin. Drive EN higher than 1.6V to turn on the regulator or less than 1.2V to turn it off. Note that floating the EN pin will turn it off.
6. An input under-voltage lockout (UVLO) function is implemented by the addition of a resistor divider (R4 and R6). The EN threshold is 1.2V (falling edge), so the input UVLO threshold is:

$$UVLO = 1.2V \times \left(1 + \frac{R6}{R4}\right)$$

The UVLO threshold is preset to 6V on this board.

7. To adjust the output voltage, change the values of R1 and R2. Generally, Choose R2 around 124kΩ for optimal transient response. For  $V_{FB}=0.8V$ ,  $R2=124k\Omega$ , R1 can be determined by:

$$R1 = \frac{99.2k\Omega}{V_{OUT}-0.8V}$$

Please follow the application information on the MP2451 datasheet to recalculate/select compensation values, the inductor value and the output capacitor value if the output voltage needs to be reprogrammed.

**NOTICE:** The information in this document is subject to change without notice. Users should warrant and guarantee that third party Intellectual Property rights are not infringed upon when integrating MPS products into any application. MPS will not assume any legal responsibility for any said applications.