

DESCRIPTION

The EVQ20056-G-00A evaluation board demonstrates the performance of MPQ20056-18, a low noise, low dropout and high PSRR linear regulator. It operates from a 2.5V to 5.5V input voltage and the output voltage is preset internally at 1.8V.

The EVQ20056-G-00A can supply up to 250mA of load current, and features current limiting, over temperature protection.

An internal PMOS pass element is used to allow a low 150 μ A ground current, making the MPQ20056-G suitable for battery-power devices.

ELECTRICAL SPECIFICATIONS

Parameter	Symbol	Value	Units
Input Voltage	V_{IN}	2.5 – 5.5	V
Output Voltage	V_{OUT}	1.8	V
Load Current	I_{OUT}	250	mA

FEATURES

- Up to 250mA Output Current
- Low 100mV Dropout at 250mA
- Fast Transient Response
- 70dB PSRR at 1kHz
- 13 μ V_{RMS} Low Noise Output
- Fixed output voltage 1.8V
- Current Limit and Thermal Protection

APPLICATIONS

- Telecom
- Cellular Phones
- DSP, FPGA Supplies
- Hand –Held Instruments
- Notebook Computers

All MPS parts are lead-free and adhere to the RoHS directive. For MPS green status, please visit MPS website under Quality Assurance. MPS[®] and "The Future of Analog IC Technology" are Registered Trademarks of Monolithic Power Systems, Inc.

EVQ20056-G-00A EVALUATION BOARD



(L x W x H) 2.5" x 2.5" x 0.4"
(6.35cm x 6.35cm x 1.1cm)

Board Number	MPS IC Number
EVQ20056-G-00A	MPQ20056-G-1.8

EVALUATION BOARD SCHEMATIC

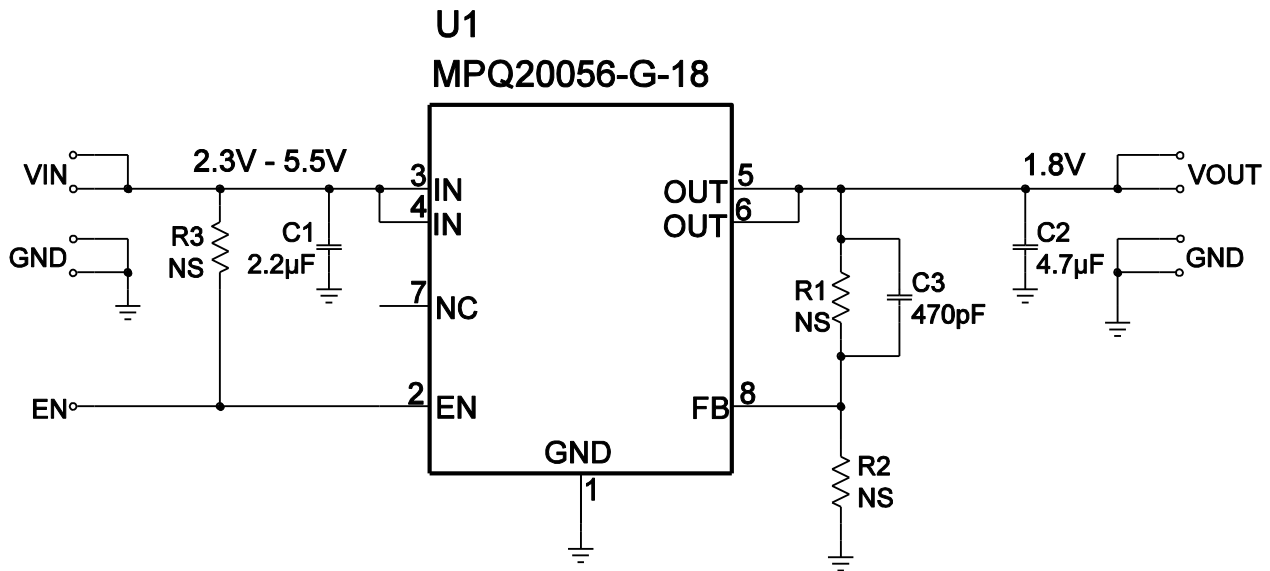

EV20056-G-00A BILL OF MATERIALS

Qty	Ref	Value	Description	Package	Manufacturer	Manufacturer P/N
1	C1	2.2µF	Ceramic Cap., 6.3V, 10%, X5R	0603	muRata	GRM188R60J225KE19D
1	C2	4.7µF	Ceramic Cap., 6.3V, 10%, X5R	0603	muRata	GRM188R60J475KE19D
1	C3	470pF	CAP, 0603, 50V, X7R, 10%	0603	muRata	GRM188R71H471KA01D
	R1,R2,R3	NS		0603		
1	U1		Linear Regulator	QFN8(2X2mm)	MPS	MPQ20056GG-18-R5
4	VIN, VOUT, GND	Test Point	Test Point	2x2.54mm	HZ	China market
1	EN	Test Point	Test Point	Test Point	HZ	China market

EVB TEST RESULTS

Performance waveforms are tested on the evaluation board.

$V_{IN} = 2.5V$, $V_{OUT} = 1.8V$, $T_A = 25^\circ C$, unless otherwise noted.

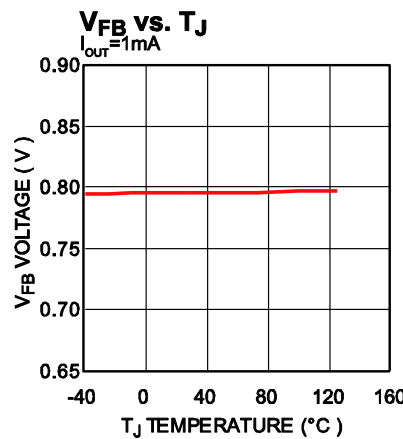
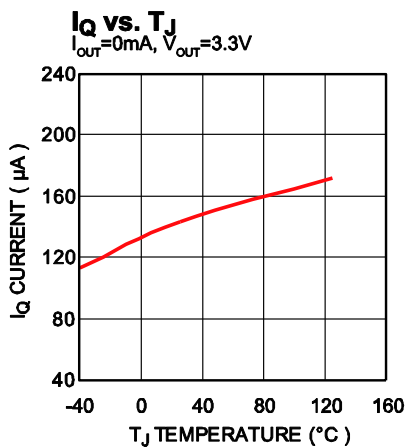
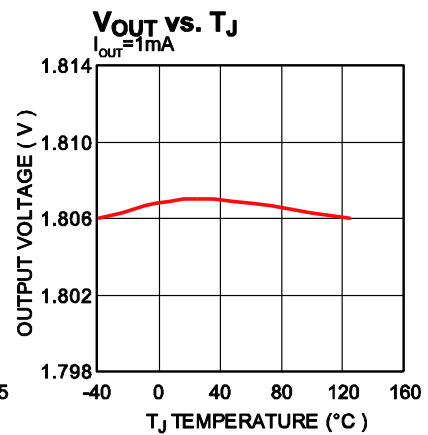
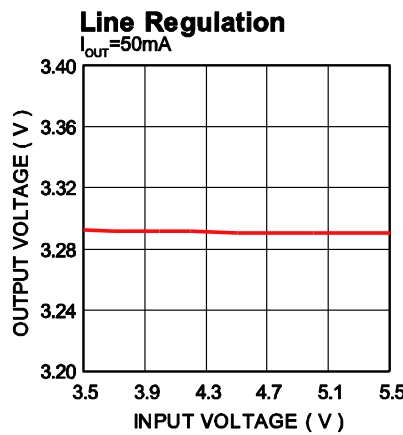
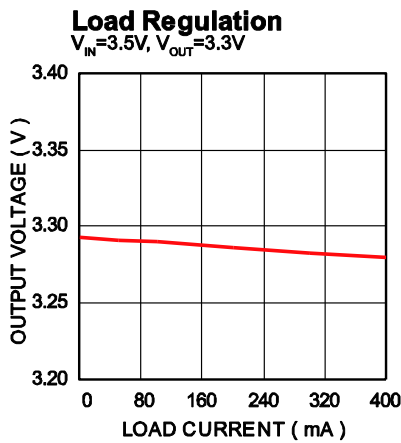
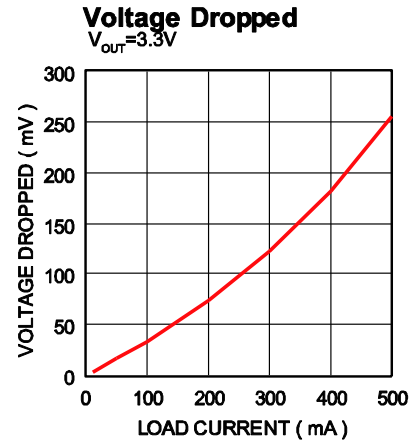
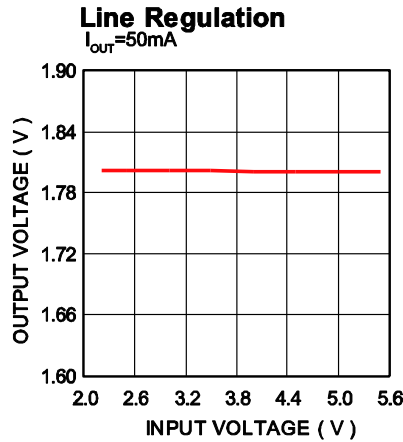
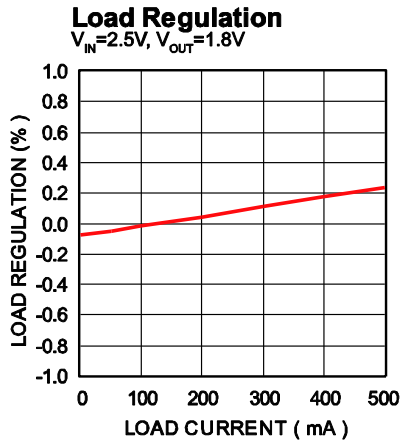

EVB TEST RESULTS *(continued)*

Performance waveforms are tested on the evaluation board.
 $V_{IN} = 2.5V$, $V_{OUT} = 1.8V$, $T_A = 25^\circ C$, unless otherwise noted.

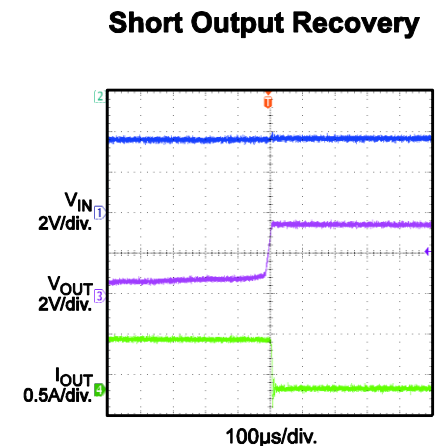
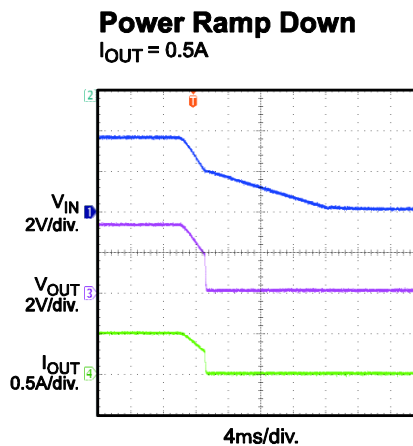
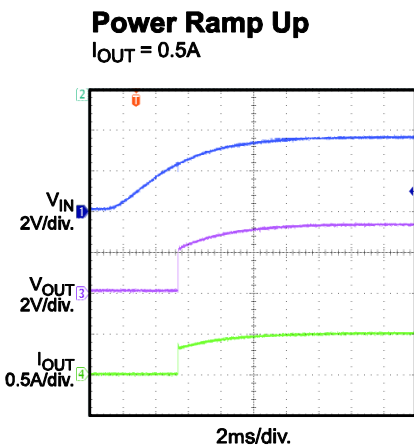
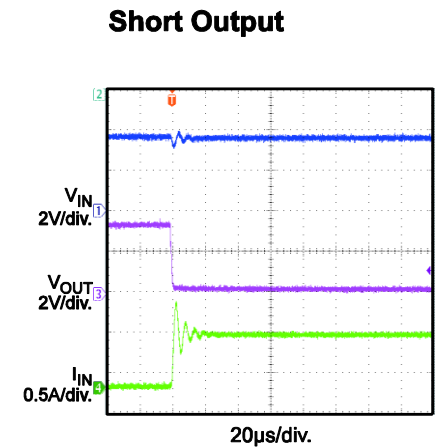
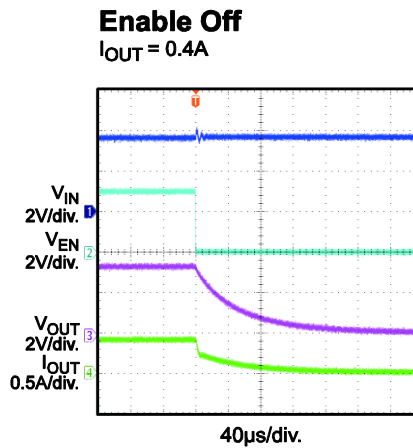
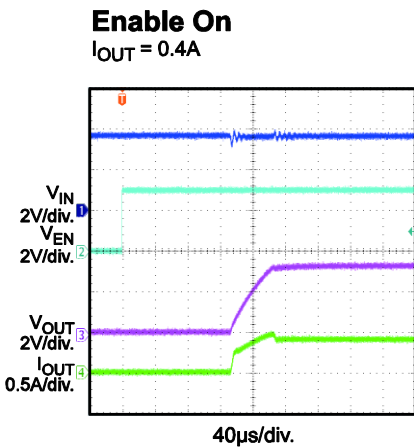
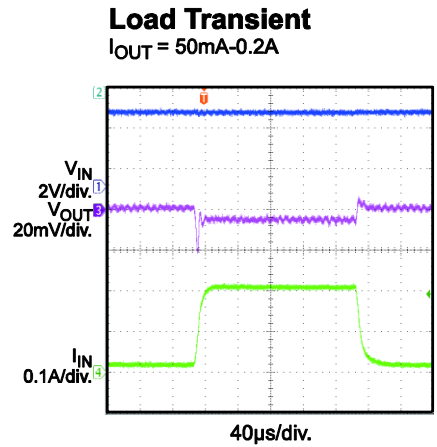
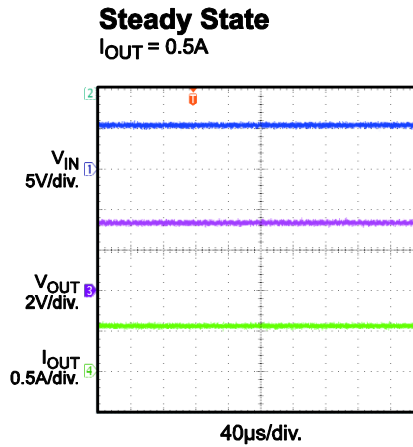
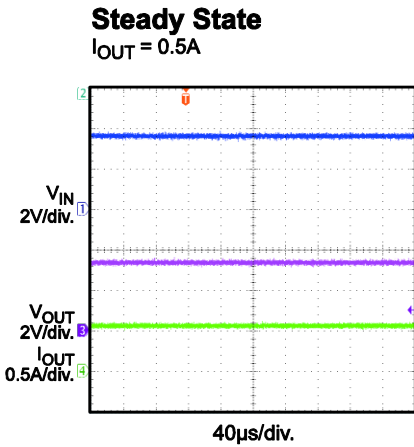

PRINTED CIRCUIT BOARD LAYOUT

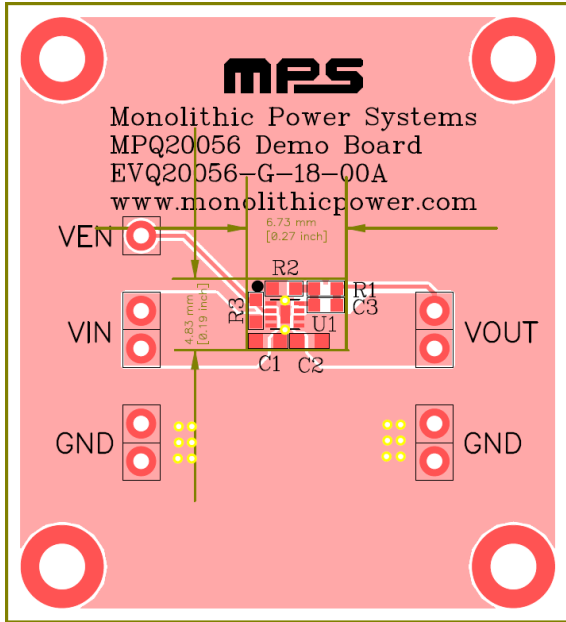

Figure 1—Top and Top Silk Layer

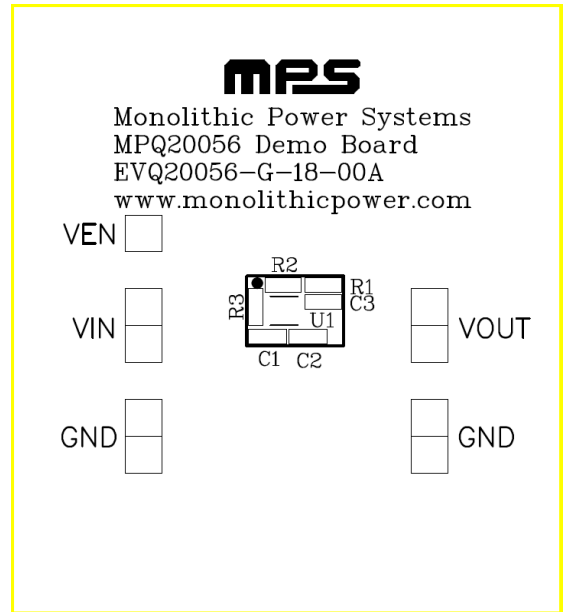

Figure 2—Top Silk Layer

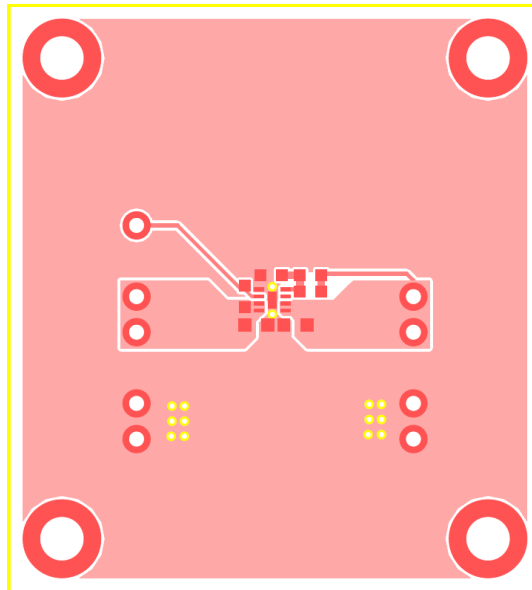

Figure 3—Top Layer

QUICK START GUIDE

1. Connect the positive terminal of the load to VOUT pins, and the negative terminal of the load to GND pins.
2. Preset the power supply output to 2.5V $<V_{IN}<5.5V$ and turn off the power supply.
3. Connect the positive terminal of the power supply output to the VIN pin and the negative terminal of the power supply output to the GND pin.
4. To use the Enable function, apply a digital input to the EN pin. Drive EN higher than 1.5V to turn on the regulator or less than 0.4V to turn it off.
5. Turn on the power supply. The EVQ20056-G will automatically start up.
6. The output voltage is fixed 1.8V.

NOTICE: The information in this document is subject to change without notice. Users should warrant and guarantee that third party Intellectual Property rights are not infringed upon when integrating MPS products into any application. MPS will not assume any legal responsibility for any said applications.