



The Future of Analog IC Technology®

EVQ18021A-S-00A

100V, High Frequency Half-Bridge Gate Driver EV Board

DESCRIPTION

This is EV board documentation for MPQ18021A. The MPQ18021A is a high frequency, 100V half bridge N-channel power MOSFET driver. Its low side and high side driver channels are independently controlled and matched with a time delay of less than 5ns. Under-voltage lockout on both high side and low side supplies force their outputs low in case of insufficient supply. The integrated bootstrap diode reduces external component count.

This demo board is configured to a buck converter. INH and INL are independent signals of each other. For simplicity, the user only need to supply a PWM signal to this demo board and the on-board circuitry will generate INH and INL signals with proper dead time. In a real system, the controller will have to take care of dead time adjustment.

ELECTRICAL SPECIFICATION

Parameter	Symbol	Value	Units
Driver Voltage	V _{DD}	9 – 18	V
Input Power Voltage	V _{POWER}	0-100	V
Duty		10	%
Output Current	I _{OUT}	4	A
Frequency	F _{SW}	200	KHz

FEATURES

- Drives N-Channel MOSFET Half Bridge
- 100V V_{BST} Voltage Range
- On-Chip Bootstrap Diode
- Typical 16ns Propagation Delay Time
- Less Than 5ns Gate Drive Matching
- Drives 1nF Load with 12ns/9ns Rise/Fall Times with 12V VDD
- TTL Compatible Input
- Less Than 150µA Quiescent Current
- UVLO for Both High Side and Low Side
- In SOIC8 Packages

APPLICATIONS

- Telecom Half Bridge Power Supplies
- Avionics DC-DC Converters
- Two-Switch Forward Converters
- Active Clamp Forward Converters

All MPS parts are lead-free and adhere to the RoHS directive. For MPS green status, please visit MPS website under Quality Assurance.

"MPS" and "The Future of Analog IC Technology", are Registered Trademarks of Monolithic Power Systems, Inc.

EVQ18021A-S-00A EVALUATION BOARD



(L x W x H) 6.4cm x 6.4cm x 3cm

Board Number	MPS IC Number
EVQ18021A-S-00A	MPQ18021AHS

EVALUATION BOARD SCHEMATIC

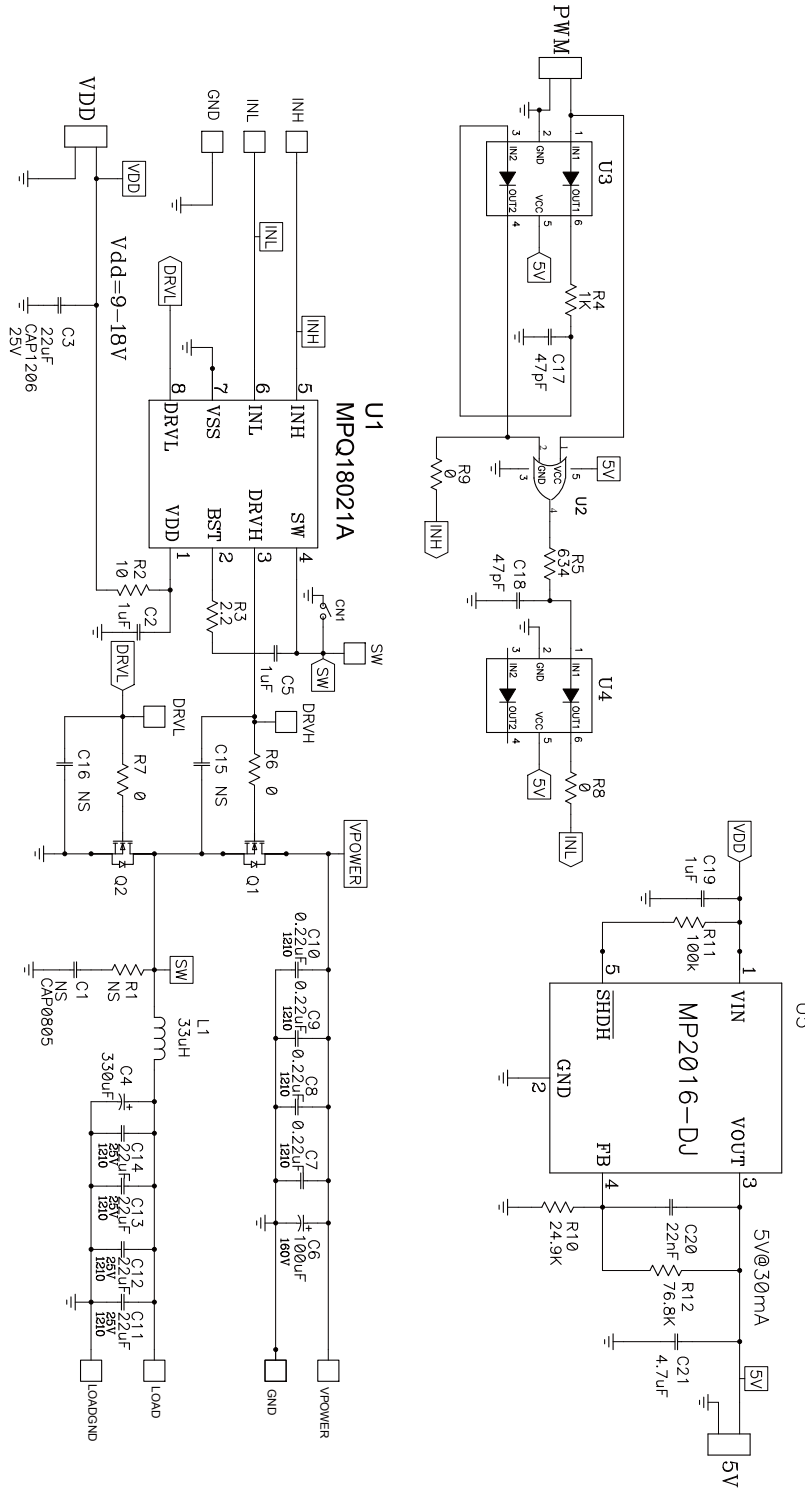

EVQ18021A-S-00A BILL OF MATERIALS

Qty	Ref	Value	Description	Package	Manufacturer	Manufacturer P/N
	C1, C15, C16	NS		0805		
3	C2, C5, C19	1.0 μ F	Ceramic Cap, 25V, X7R	0603	MuRata	GRM188R71E105 KA12D
1	C3	22 μ F	Ceramic Cap, 25V, X5R	1206	MuRata	GRM31CR61E226 KE15L
1	C4	330 μ F	25V Elec. Alu. Cap	JA0	Chemicon	EMZE250ADA331 MJA0G
1	C6	100 μ F	160V, Aluminium Cap	12.5X25X5 mm	Panasonic	ECA-2CM101
4	C7, C8, C9, C10	0.22 μ F	Ceramic Cap, 250V	1210	MuRata	GRM32DR72E224 KW01
4	C11, C12, C13, C14	22 μ F	Ceramic Cap, 25V, X5R	1210	MuRata	GRM32ER61E226 KE15L
2	C17, C18	47pF	Ceramic Cap, 50V, C0G	0603	MuRata	GRM1885C1H470J A01D
1	C20	22nF	Ceramic Cap, 25V, X7R	0603	MuRata	GRM188R71E223J A01D
1	C21	4.7 μ F	Ceramic Cap, 6.3V, X5R	0603	MuRata	GRM188R60J475 ME19D
1	L1	33 μ H	DCR=21.7m Ω , Isat=9A	18x18x9mm	Würth	WE74435573300
2	Q1, Q2	150V/30A	N-channel PowerPak MOSFET	PowerPak SO-8	Vishay	Si7738DP
	R1	NS		0603		
1	R2	10 Ω	Film Resistor, 5%	0603	Yageo	RC0603JR-0710RL
1	R3	2.2 Ω	Film Resistor, 5%	0603	Yageo	RC0603JR-072R2L
1	R4	1k Ω	Film Resistor, 1%	0603	Yageo	RC0603FR-071KL
1	R5	634 Ω	Film Resistor, 1%	0603	Yageo	RC0603FR-07634RL
4	R6, R7, R8, R9	0 Ω	Film Resistor	0603	Yageo	RC0603JR-070RL
1	R10	24.9k Ω	Film Resistor, 1%	0603	Yageo	RC0603FR-0724K9L
1	R11	100k Ω	Film Resistor, 1%	0603	Yageo	RC0603FR-07100KL
1	R12	76.8k Ω	Film Resistor, 1%	0603	Yageo	RC0603FR-0776K8L
1	U1	MPQ18021A	100V Half Bridge Driver	SOIC-8 EP	MPS	MP18021AHS
1	U2	OR Gate	2-input OR Gate	SOT23-5	Fairchild Semiconductor	NC7S32M5
2	U3, U4	Inverter	Dual Inverter	SC70	Fairchild Semiconductor	NC7WZ14P6X
1	U5	MP2016	LDO, 5V, 30mA	SOT23-5	MPS	MP2016DJ

EVB TEST RESULTS

Performance waveforms are tested on the evaluation board.

$V_{POWER} = 100V$, $V_{DD} = 12V$, $I_{LOAD} = 4A$, Duty=10%, $L = 33\mu H$, Frequency=200KHz, $T_A = 25^\circ C$, unless otherwise noted.

INH to DRVH Delay with MOSFET

Note: V_{POWER} is not applied

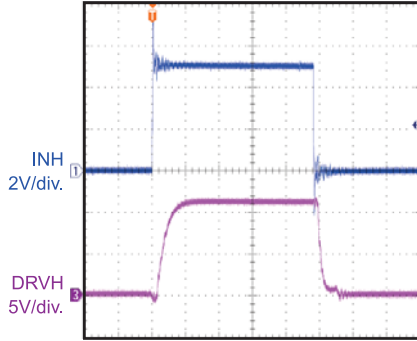

INL to DRVL Delay with MOSFET

Note: V_{POWER} is not applied

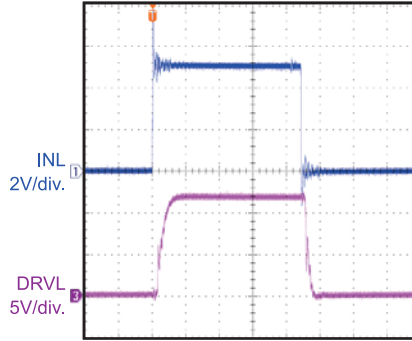

Generated INH and INL from PWM

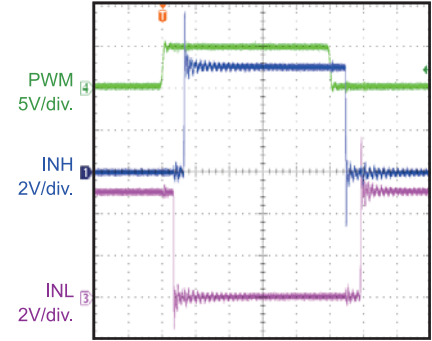

Input Signals and SW Node

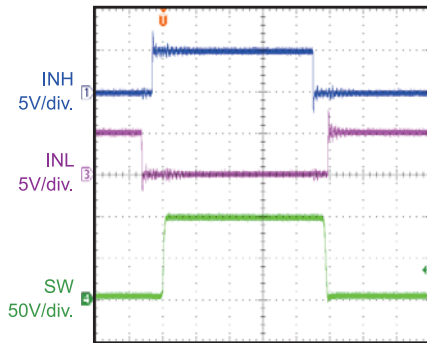

Gate Signals and SW Node

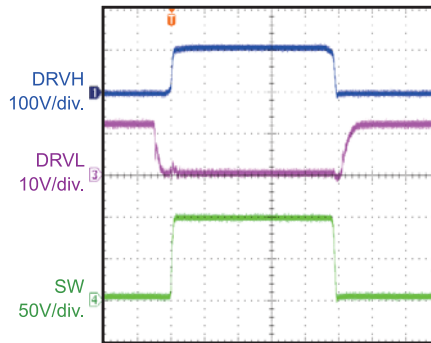

PRINTED CIRCUIT BOARD LAYOUT

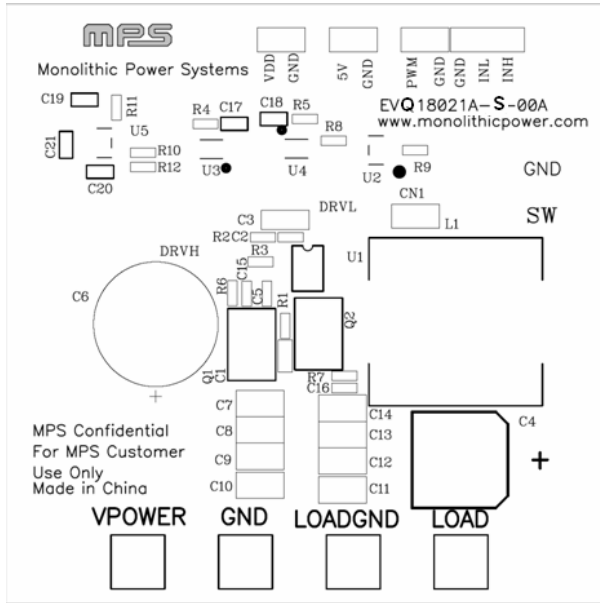

Figure 1: Top Silk Layer

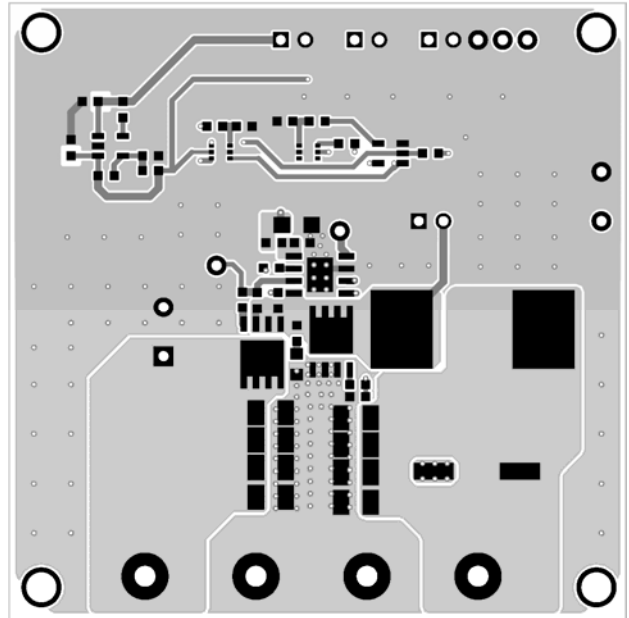

Figure 2: Top Layer

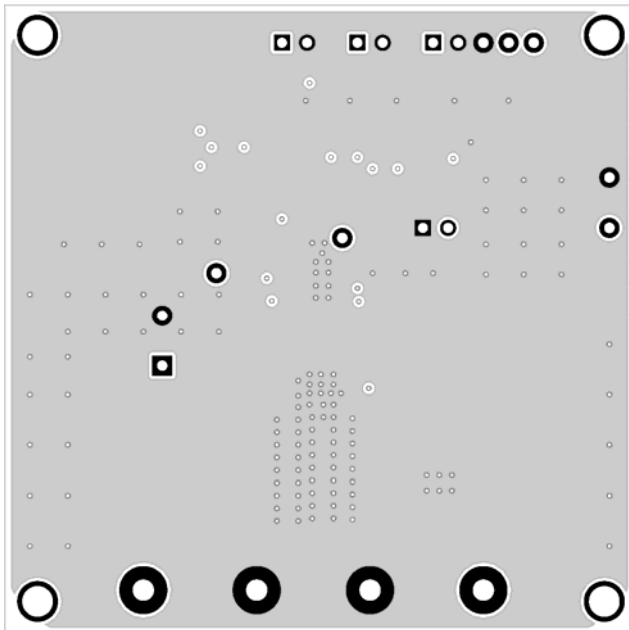

Figure 3: Inner 1 Layer & Inner 2 Layer

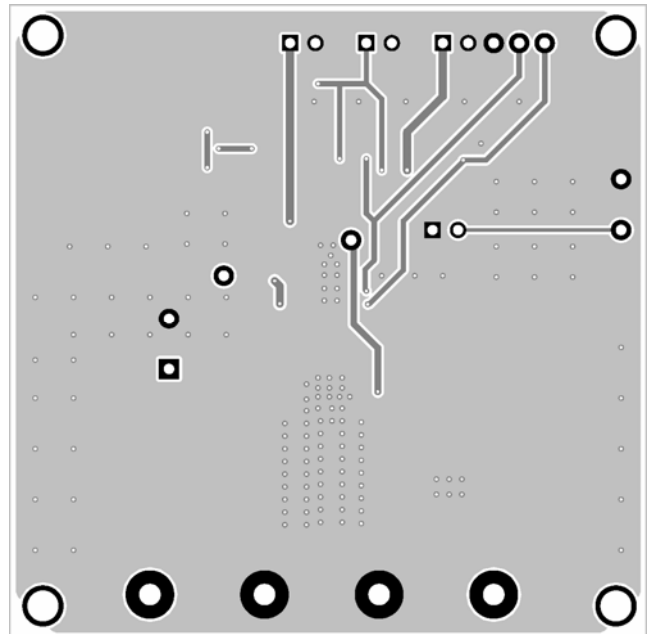

Figure 4: Bottom Layer

QUICK START GUIDE

EVQ18021A-S-00A is configured in a buck converter. Below is the recommended setting for users to evaluate the EV board. User must watch for inductor saturation (do not set switching frequency too low) and over temperature (do not increase duty).

1. Preset Driver Power Supply between 9V-18V.
2. Preset Input Power Supply between 0V-100V.
3. Connect Driver Power Supply terminals to:
 - a. Positive (+): VDD
 - b. Negative (-): GND
4. Connect Input Power Supply terminals to:
 - a. Positive (+): VPOWER
 - b. Negative (-): GND
5. Connect Load to:
 - a. Positive (+): LOAD
 - b. Negative (-): LOADGND
6. Function Generator setting:
 - a. Frequency: 200 KHz
 - b. Logic High: 5V
 - c. Logic Low: 0V
 - d. Duty: 10%
 - e. Rising/Falling Edge Slew Rate: As fast as possible
7. Connect Function Generator's output to PWM and GND pins. Turn on Function Generator's output.
8. Turn on Driver Power Supply.
9. Check INH, INL, DRVH and DRVL signals. Make sure there are dead time between DRVH high and DRVL high to avoid shoot through.
10. If all signals are correct, then turn on Input Power Supply.
11. User may load up to 4A of output current. Higher load current may cause overheat to the MOSFET.
12. To turn off the board, please follow these steps:
 - a. Turn off load.
 - b. Turn off Input Power Supply.
 - c. Turn off Driver Power Supply.

NOTICE: The information in this document is subject to change without notice. Please contact MPS for current specifications. Users should warrant and guarantee that third party Intellectual Property rights are not infringed upon when integrating MPS products into any application. MPS will not assume any legal responsibility for any said applications.