

DESCRIPTION

The EVNB675L-L-00A is an evaluation board for the NB67LGL, the lower quiescent current version of NB675.

The Evaluation Board can deliver 10A continuous load current from a 4.7V to 22V input with excellent load and line regulation.

Constant-On-Time (COT) control mode provides fast transient response and eases loop stabilization.

The Evaluation Board can be turned on or shut down via a remote ON/OFF input that is reference to ground. This input is compatible with popular logic devices.

This part requires minimum number of external components and is available in QFN21 (3mmx4mm) package

ELECTRICAL SPECIFICATION

Parameter	Symbol	Value	Units
Input Voltage	V_{IN}	4.7-22	V
Output Voltage	V_{OUT}	1.2	V
Output Current	I_{OUT}	10	A
Switching Frequency	f_{SW}	500	kHz

FEATURES

- Wide 4.7V to 24V Operating Input Range
- 10A Continuous Output Current
- 12A Peak Output Current
- Built-in +/- 1.5A VTTLDO
- 105µA Quiescent Current
- Low $R_{DS(ON)}$ Internal Power MOSFETs
- Proprietary Switching Loss Reduction Technique
- Internal Soft Start
- Output Discharge
- 500kHz Switching Frequency for NB675L
- 750kHz Switching Frequency for NB675LH
- OCP, OVP, UVP Protection and Thermal Shutdown
- VDDQ Adjustable from 0.6V to 5.5V

APPLICATIONS

- Laptop Computer
- Tablet PC
- Networking Systems
- Server
- Personal Video Recorders
- Flat Panel Television and Monitors
- Distributed Power Systems

All MPS parts are lead-free and adhere to the RoHS directive. For MPS green status, please visit MPS website under Products, Quality Assurance page.

"MPS" and "The Future of Analog IC Technology", are Registered Trademarks of Monolithic Power Systems, Inc.

EVNB675L-L-00A EVALUATION BOARD

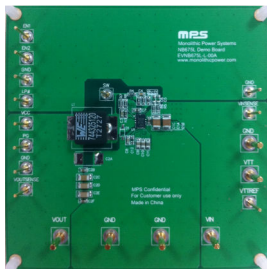

(L × W × H) 8.55cm × 8.55cm × 1.6cm

Board Number	MPS IC Number
EVNB675L-L-00A	NB675LGL

Efficiency vs. Load Current

$V_O=1.2V$, $F_s=500kHz$,
 $L=1.2\mu H$, $DCR=2m\Omega$

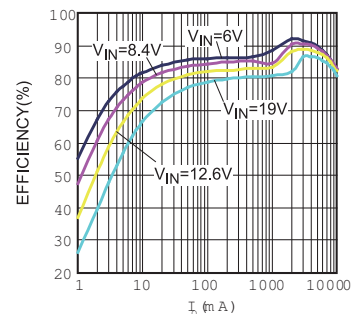

EVALUATION BOARD SCHEMATIC

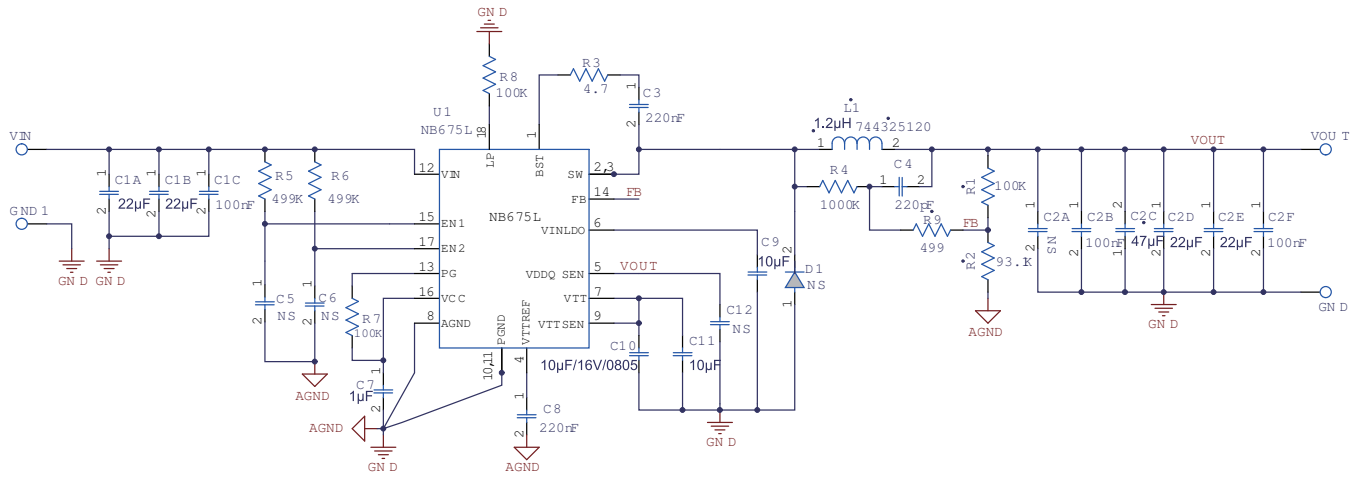

EVNB675L-L-00A BILL OF MATERIALS

Qty	Ref	Value	Description	Package	Manufacture	Part Number
12	VTTREF, VOUTSENSE, VINSENSE, VCC,SW, PG,LP#, GND_VIN, GND_sen, GND3, EN2,EN1	VTTREF	Connector	CONN/1MM		
6	VTT,VOUT, VIN, GND_VTT, GND,GND2,	VTT	Connector	CONN/2MM		
1	D1	NS	Schottky Diode; 40V;0.5A	SOD-123		
1	R4	1M	Film Resistor;1%;	0603	Yageo	RC0603FR-071ML
3	C5, C6, C12	NS	Ceramic Capacitor; 16V;X7R;0603	0603		
2	R5, R6	499K	Film Resistor;1%;	0603	Yageo	RC0603FR-07499KL
1	R9	499	Film Resistor;1%	0603	Yageo	RC0603FR-07499RL
1	C2A	NS	6.3V;POSCAP	POSCAP		
1	C4	220pF	Ceramic Capacitor; 50V;X7R;0603;	0603	muRata	GRM188R71H221KA01D
2	C3, C8	220nF	Ceramic Capacitor; 16V;X7R;0603;	0603	muRata	GRM188R71C224KA01
3	C1C, C2B, C2F	100nF	CeramicCapacitor; 16V;X7R;0603;; Ceramic Capacitor; 50V;X7R;0603;	0603	muRata	GRM188R71C104KA01D, GRM188R71H104KA93D
3	R1, R7, R8	100K	Film Resistor;1%;	0603	Yageo	RC0603FR-07100KL
1	R2	93.1K	Film Resistor;1%	0603	Yageo	RC0603FR-0793K1L
1	C2C	47µF	Ceramic Capacitor; 6.3V;X5R;1206;	1206	muRata	JMK316BJ476ML-T
2	C1A, C1B	22µF	Ceramic Capacitor; 25V;X5R;1210;	1210	muRata	GRM32ER61E226KE15L
2	C2D, C2E	22µF	Ceramic Capacitor; 6.3V;X5R;1206	1206	muRata	GRM31CR60J226KE19
3	C9, C10, C11	10µF	Ceramic Capacitor; 16V;X7R	0805	Murata	GRM21BR61C106KE15
1	R3	4.7	Film Resistor;5%	0603	Yageo	RC0603JR-074R7L
1	L1	1.2µH	Inductor;1.2uH; 2m;25A	SMD	Wurth	744325120
1	C7	1µF	Ceramic Capacitor; 6.3V;X5R;0603	0603	muRata	GRM188R60J105KA01D
1	U1	NB675L	Synchronous Buck converter	QFN3*4	MPS	NB675LGL

EVB TEST RESULTS

Performance waveforms are tested on the EVNB675L-L-00A.

$V_{IN} = 20V$, $V_{OUT} = 1.2V$, $L = 1.2\mu H$, $T_A = 25^\circ C$, unless otherwise noted.

Efficiency vs. Load Current

$V_o = 1.2V$, $F_s = 500kHz$,
 $L = 1.2\mu H$, $DCR = 2m\Omega$

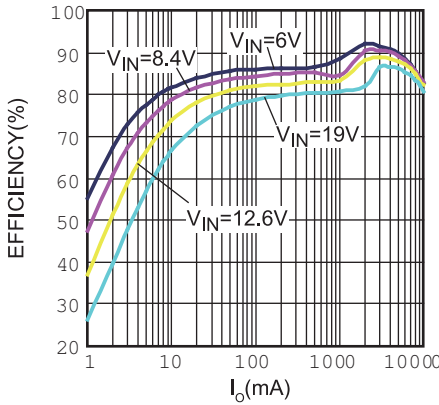

Power Loss vs. Load Current

$V_o = 1.2V$, $F_s = 500kHz$,
 $L = 1.2\mu H$, $DCR = 2m\Omega$

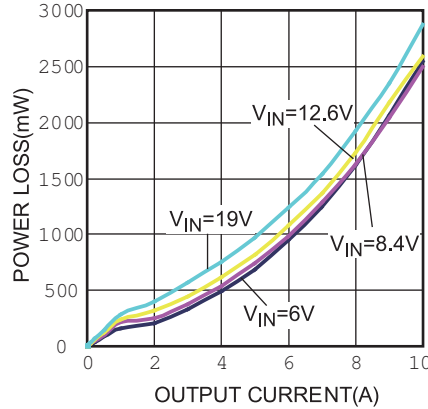

Load Regulation

$V_o = 1.2V$, $F_s = 500kHz$,
 $L = 1.2\mu H$, $DCR = 2m\Omega$

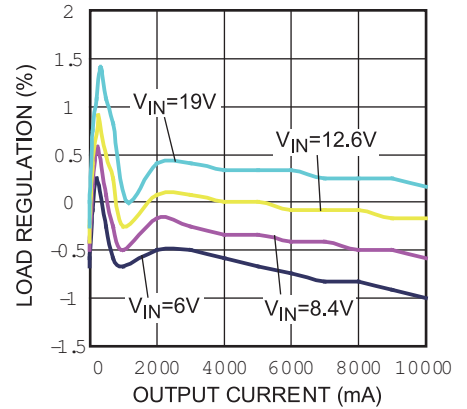

Line Regulation

$V_o = 1.2V$, $F_s = 500kHz$,
 $L = 1.2\mu H$, $DCR = 2m\Omega$

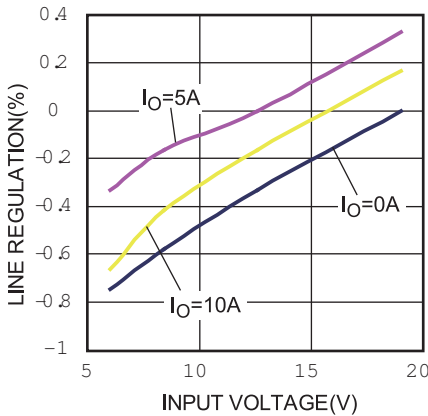

VTT LDO Sink Current Load Regulation

$V_{DDQ} = 1.2V$, $V_{TT} = V_{DDQ}/2$, $I_o = 5A$

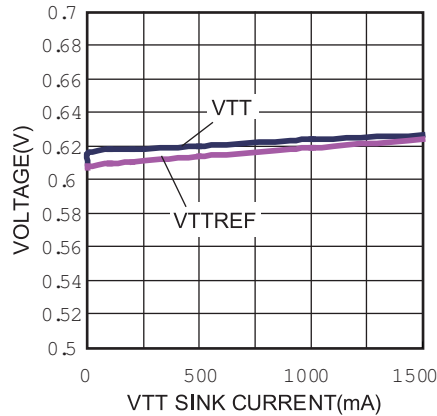

VTT LDO Source Current Load Regulation

$V_{DDQ} = 1.2V$, $V_{TT} = V_{DDQ}/2$, $I_o = 5A$

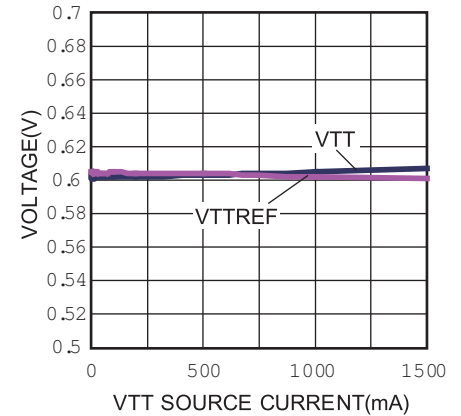

EVB TEST RESULTS (continued)

Performance waveforms are tested on the EVNB675L-L-00A.

$V_{IN} = 20V$, $V_{OUT} = 1.2V$, $L = 1.2\mu H$, $T_A = 25^\circ C$, unless otherwise noted.

Input/ Output Voltage Ripple $I_O = 0A$ Input/ Output Voltage Ripple $I_O = 1A$ Power Good through Min Start-up $I_O = 1A$

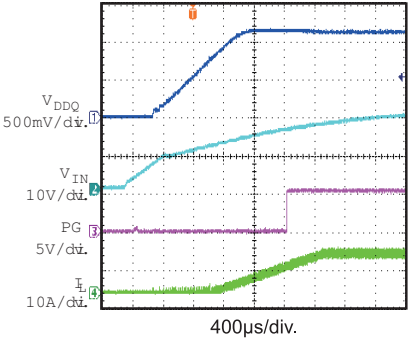
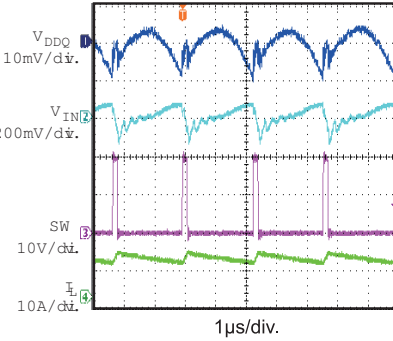
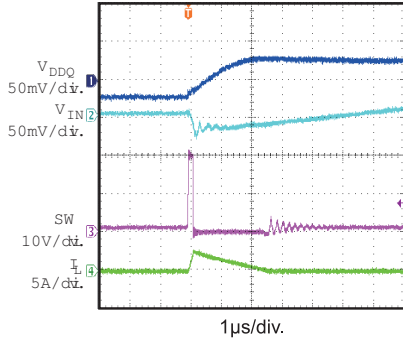

Power Good through Min Shutdown $I_O = 1A$

Power Good through EN Start-up $I_O = 1A$

Power Good through EN Shutdown $I_O = 1A$

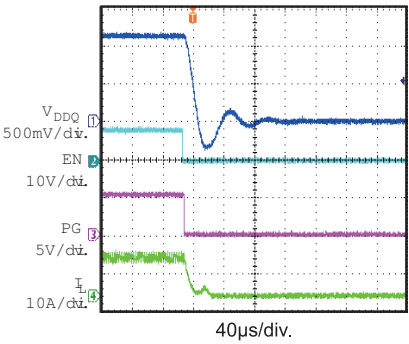
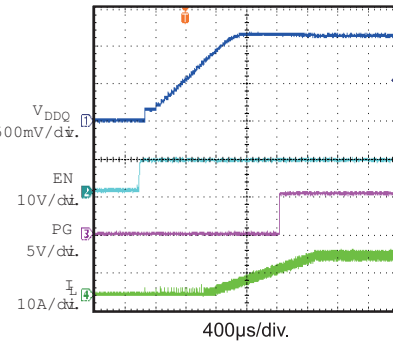
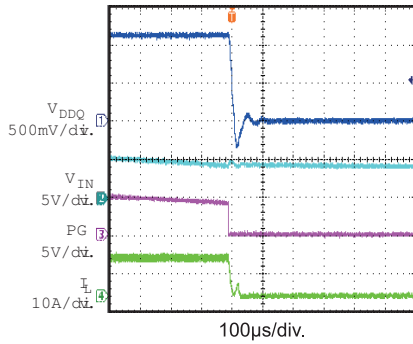

Start up through Min $I_O = 0A$

Start up through Min $I_O = 1A$

Shutdown through Min $I_O = 0A$

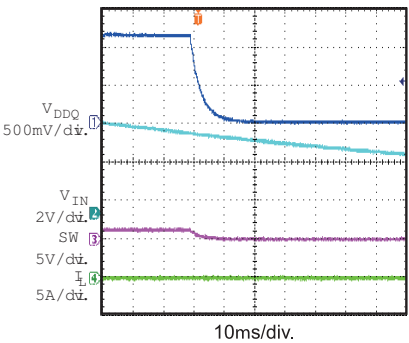
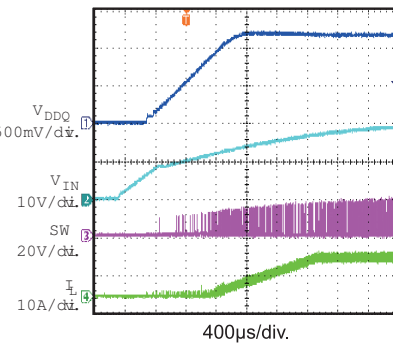
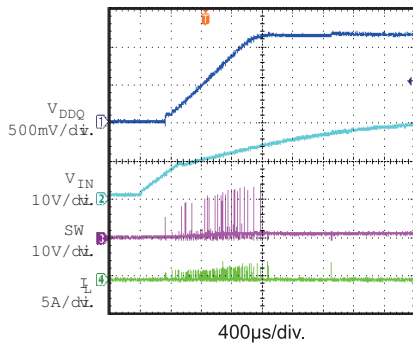

EVB TEST RESULTS (continued)

Performance waveforms are tested on the EVNB675L-L-00A.
 $V_{IN} = 20V$, $V_{OUT} = 1.2V$, $L = 1.2\mu H$, $T_A = 25^\circ C$, unless otherwise noted.

Shutdown through Vin
 $I_O = 10A$

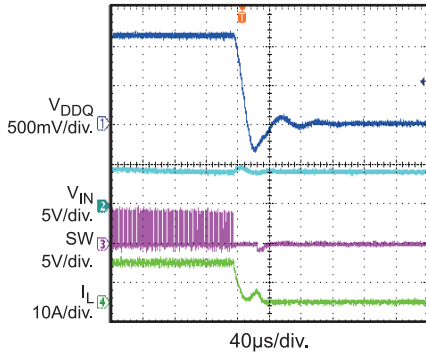

Start up through EN
 $I_O = 0A$

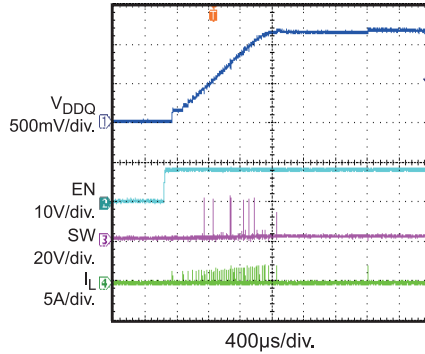

Start up through EN
 $I_O = 10A$

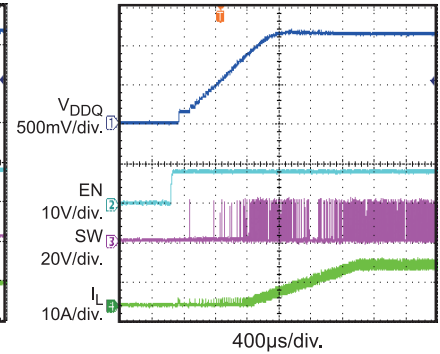

Shutdown through EN
 $I_O = 0A$

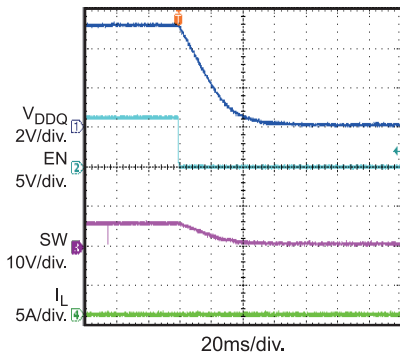

Shutdown through EN
 $I_O = 1A$

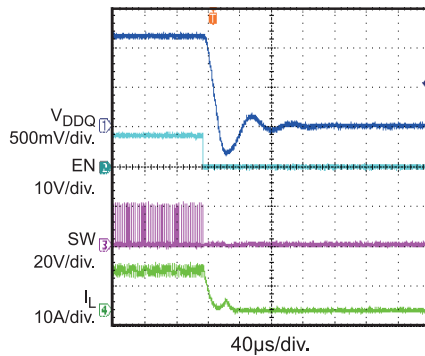

Transient
 $I_O = 1\sim 9A @ 1A/\mu s$, $F_{sw} = 500kHz$
 $C_O = 22\mu F * 2 + 47\mu F$

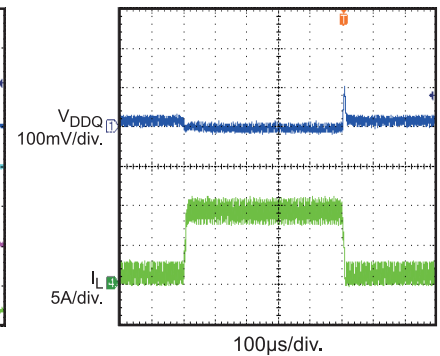

VTT&VTTREF Start-Up through Vin
 $I_O = 0A$

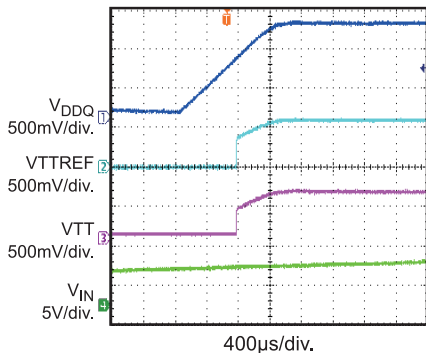

VTT&VTTREF Shut-Down through Vin
 $I_O = 0A$

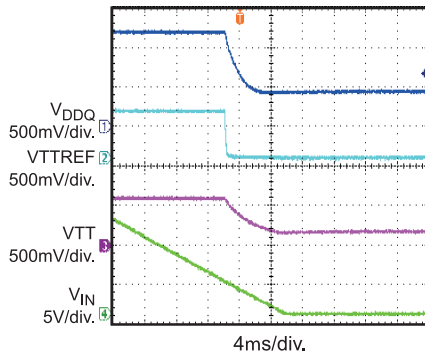

VTT&VTTREF Start-Up through EN2
 $I_O = 0A$

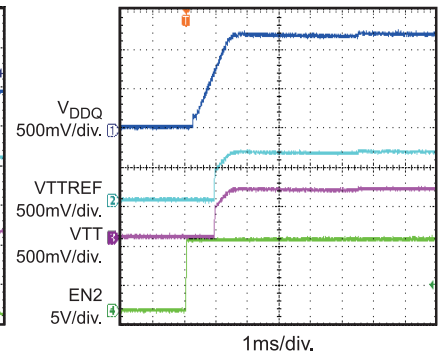

EVB TEST RESULTS (continued)

Performance waveforms are tested on the EVNB675L-L-00A.

$V_{IN} = 20V$, $V_{OUT} = 1.2V$, $L = 1.2\mu H$, $T_A = 25^\circ C$, unless otherwise noted.

VTT&VTTREF Shut-Down through EN2
 $I_O = 0A$

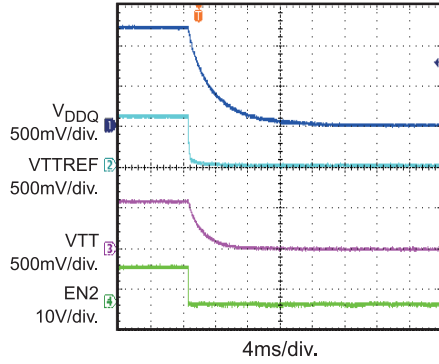

VTT Start-up through EN1
 $I_O = 0A$

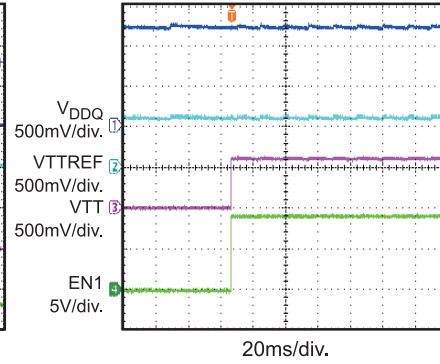

VTT Start-up through EN1
 $I_O = 0A$

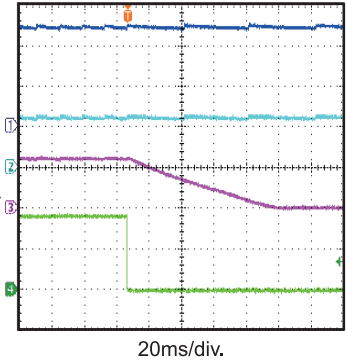

Short Circuit Protection

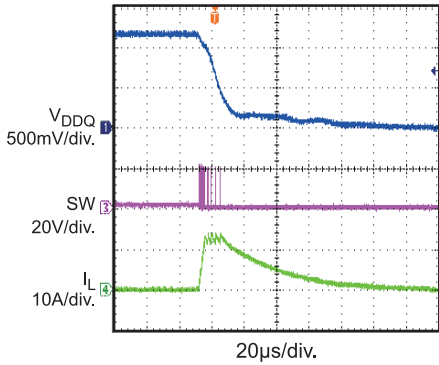

Thermal Shutdown
 $I_O = 10A$

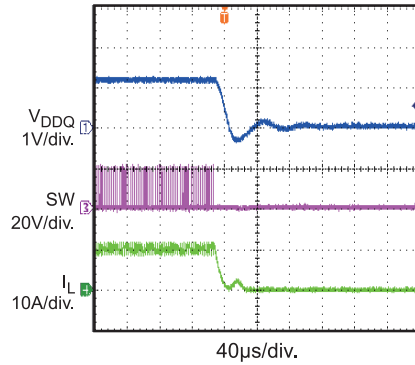

Thermal Recovery
 $I_O = 10A$

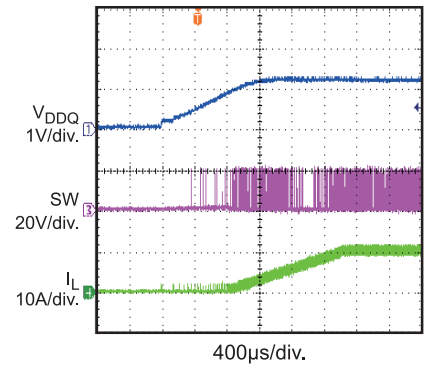

PRINTED CIRCUIT BOARD LAYOUT

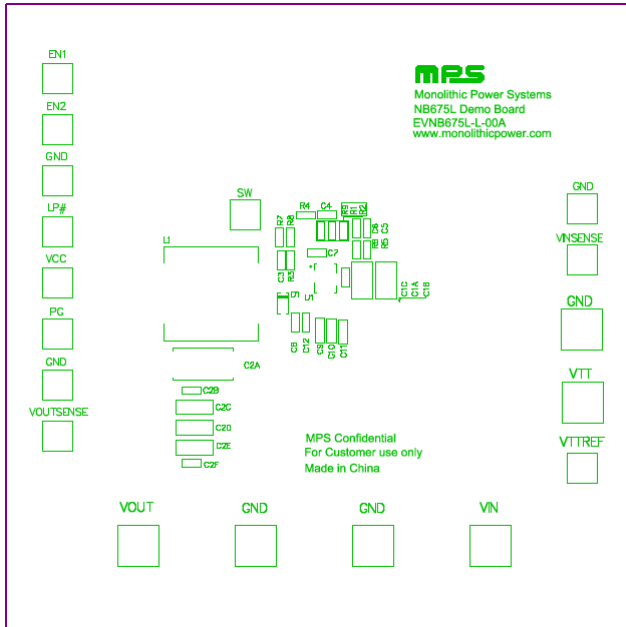

Figure 1: Top Silk Layer

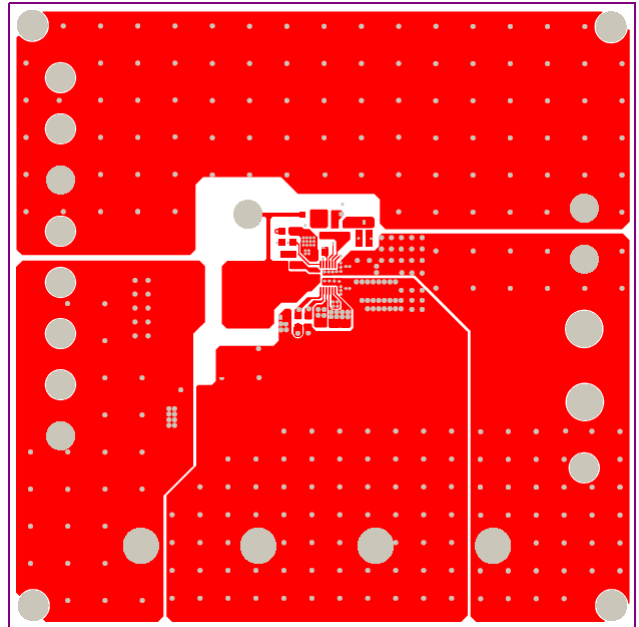

Figure 2: Top Layer

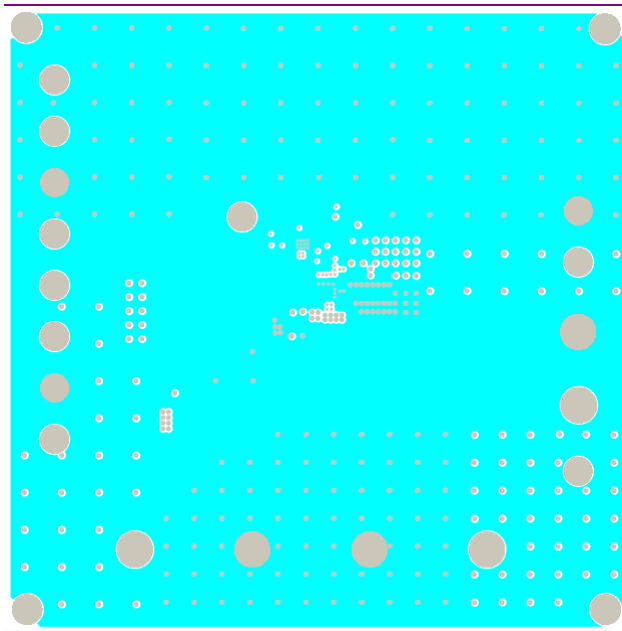

Figure 3: Inner Layer1

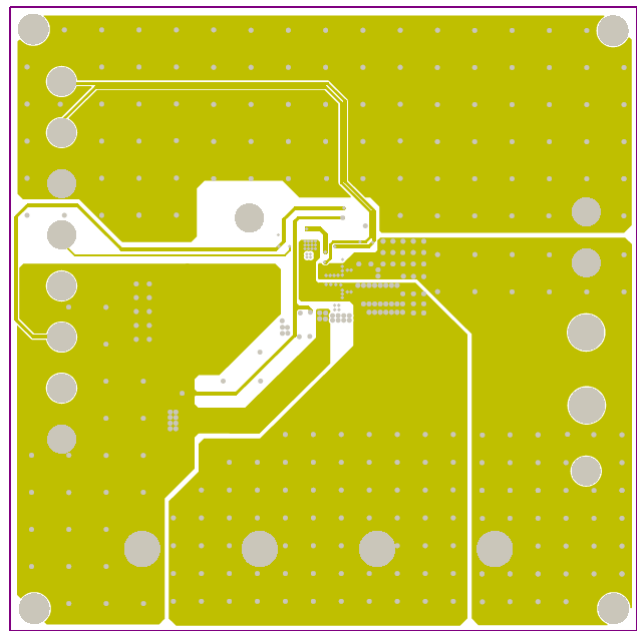

Figure 4: Inner Layer2

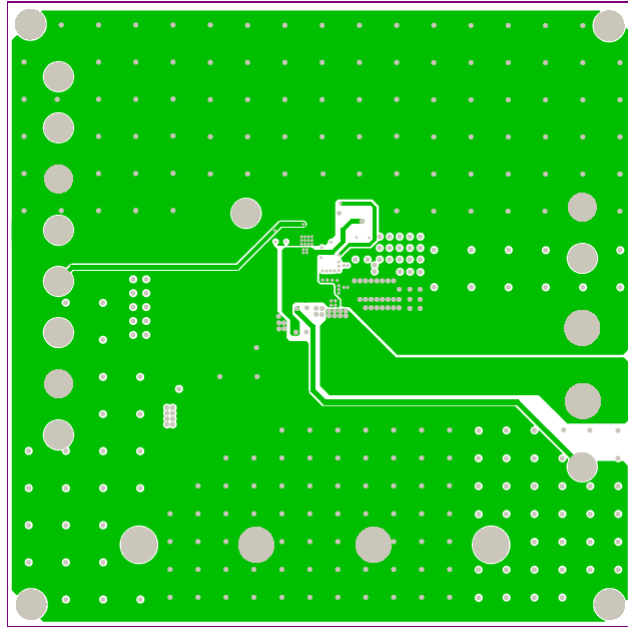

Figure 5: Bottom Layer

QUICK START GUIDE

1. Connect the positive and negative terminals of the load to the VOUT and GND pins respectively.
2. Preset the output of power supply between 4.7V and 22V, and then turn off the power supply.
3. Connect the positive and negative terminals of the power supply output to the VIN and GND pins respectively:
4. Turn the power supply on. The NB675LGL will automatically start up.
5. To use the Enable function, apply a digital input to the EN pin. Drive EN higher than 2V to turn on the regulator or less than 0.4V to turn it off
6. Use R1 and R2 to set the output voltage within $V_{FB}=0.6V$. Follow the Application information section in the device datasheet to select the proper value of R1, R2, inductor and output capacitor values when output voltage is changed
7. If low ripple at light loads is needed, then use TOKO 1.5 μ H or 2 μ H L1. But with the larger L1, the transient response peak to peak value will become larger too.

NOTICE: The information in this document is subject to change without notice. Please contact MPS for current specifications. Users should warrant and guarantee that third party Intellectual Property rights are not infringed upon when integrating MPS products into any application. MPS will not assume any legal responsibility for any said applications.