

DESCRIPTION

The MPM3840 is a monolithic step-down converter with built-in internal power MOSFETs and inductor. The DC-DC module is housed in a small surface QFN package which is sized 3mm width by 5mm length by 1.6mm height. It can provide 4A continuous output current from a 2.8V to 5.5V input voltage with excellent load and line regulation. The MPM3840 is ideal for powering portable equipment that runs with a single cell Lithium-Ion (Li+) Battery. The output voltage can be regulated as low as 0.6V. Only input, output capacitors and FB resistors are needed to complete the design.

The Constant-On-time (COT) control scheme provides fast transient response high light-load efficiency and easy loop stabilization. Fault condition protection includes cycle-by-cycle current limit and thermal shutdown.

The MPM3840 requires a minimum number of readily available standard external components and is available in an ultra-small QFN-20 (3mmx5mm) package.

ELECTRICAL SPECIFICATION

Parameter	Symbol	Value	Units
Input Voltage	V_{IN}	2.8– 5.5	V
Output Voltage	V_{OUT}	1.2	V
Output Current	I_{OUT}	4	A

FEATURES

- Above 80% Light Load Efficiency
- Low IQ: 40µA
- Wide 2.8V to 5.5V Operating Input Range
- Output Voltage as Low as 0.6V
- 100% Duty Cycle in Dropout
- 4A Output Current
- 25mΩ and 12mΩ Internal Power MOSFET
- 1.2MHz Frequency
- EN and Power Good for Power Sequencing
- Available in a QFN-20 (3mmx5mmx1.6mm)
- Cycle-by-Cycle Over Current Protection
- 1.5ms Internal SS Time with Pre-Bias Startup
- Short Circuit Protection with Hiccup Mode
- Thermal Shutdown
- Stable with Low ESR Output Ceramic Capacitors

APPLICATIONS

- Wireless Card
- Smart Phone
- Noise Sensitive Application
- Low Voltage I/O System Power

All MPS parts are lead-free, halogen free, and adhere to the RoHS directive. For MPS green status, please visit MPS website under Quality Assurance. "MPS" and "The Future of Analog IC Technology" are Registered Trademarks of Monolithic Power Systems, Inc.

EVM3840-QV-00A EVALUATION BOARD

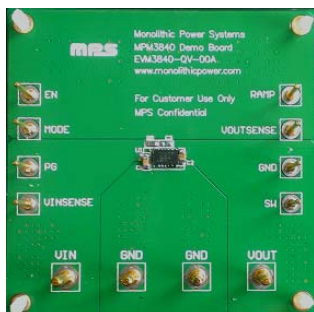

Board Number	MPS IC Number
EVM3840-QV-00A	MPM3840GQV

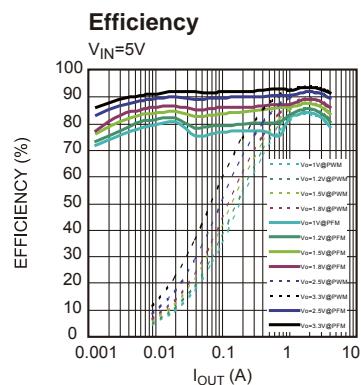

EVALUATION BOARD SCHEMATIC

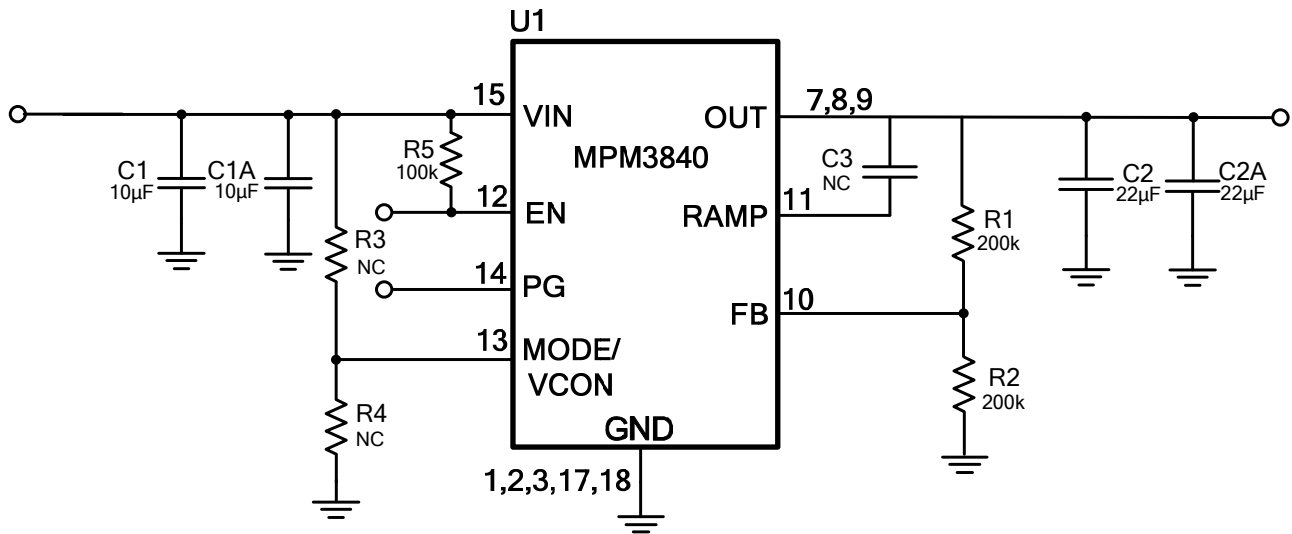

EVM3840-QV-00A BILL OF MATERIALS

Qty	Ref	Value	Description	Package	Manufacturer	Manufacturer P/N
2	R1, R2	200kΩ	Film Res,1%	0603	ROYAL	RL0603FR-07200K5L
0	R3,R4,C3	NC				
1	R5	100k	Film Res,1%	0603	ROYAL	RL0603FR-07100KL
2	C2A,C2	22µF	Ceramic Cap,10V,X5R	0805	muRata	GRM21BR61A226ME51L
2	C1,C1A	10µF	Ceramic Cap,10V,X5R	0805	muRata	GRM21BR61A106ME51L

EVB TEST RESULTS

Performance waveforms are tested on the evaluation board.

$V_{IN}=5V$, $V_{OUT}=1.2V$, $T_A = 25^{\circ}C$, unless otherwise noted.

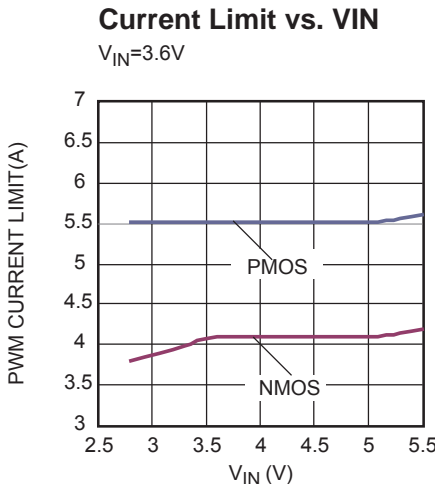
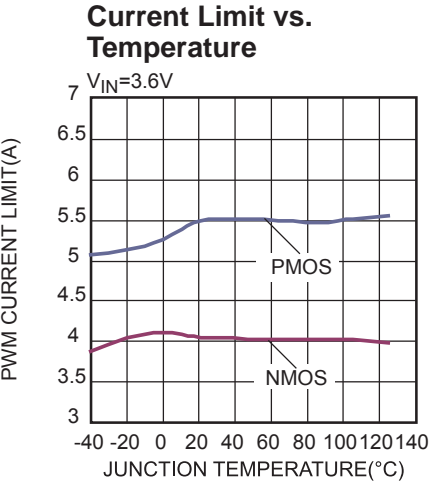
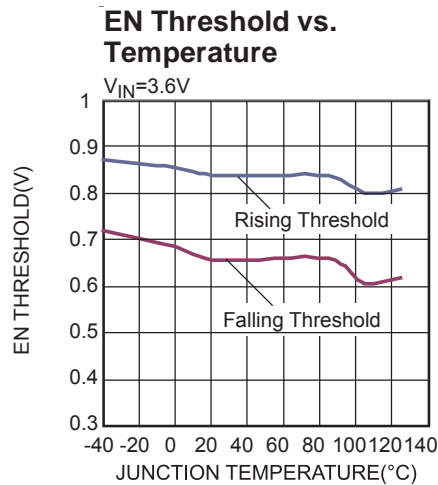
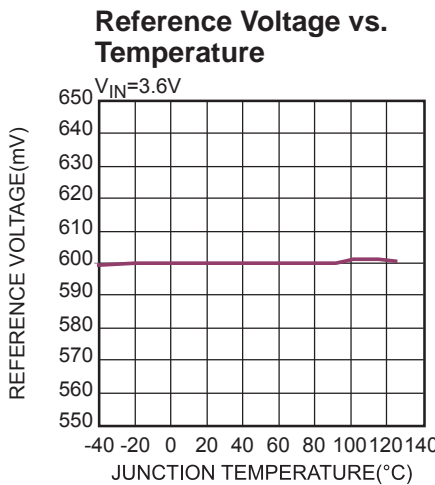
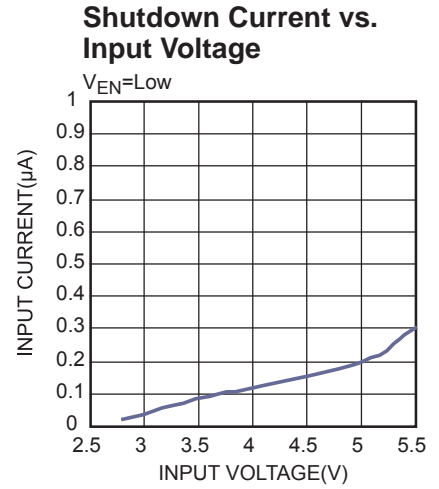
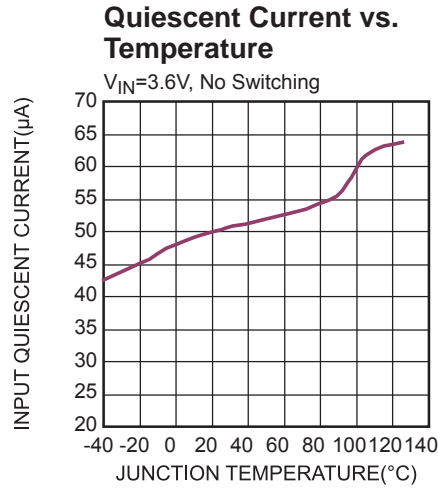
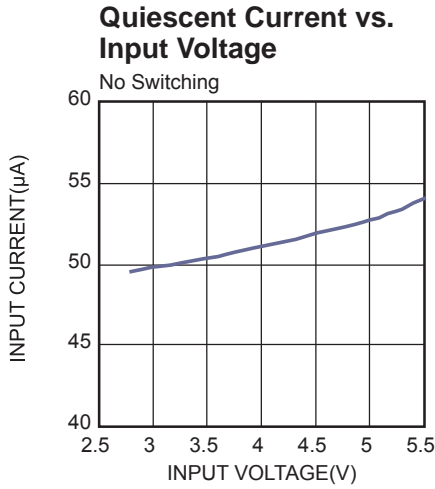

EVB TEST RESULTS *(continued)*

Performance waveforms are tested on the evaluation board.

$V_{IN}=5V$, $V_{OUT}=1.2V$, $T_A = 25^{\circ}C$, unless otherwise noted.

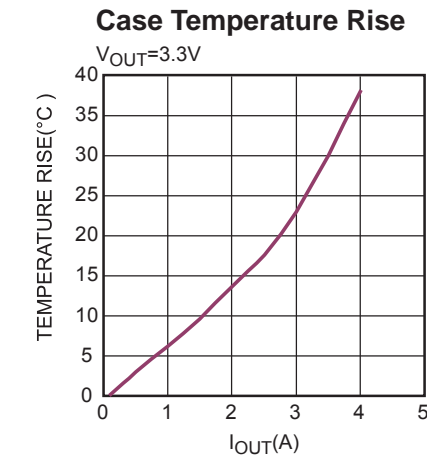
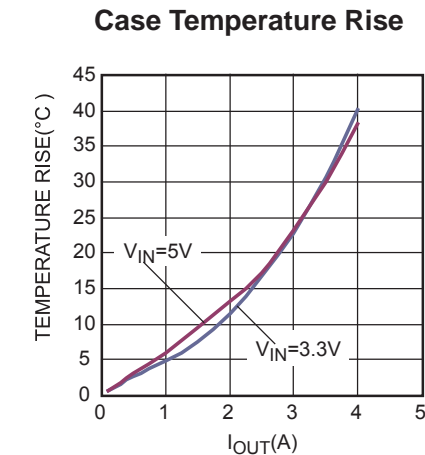
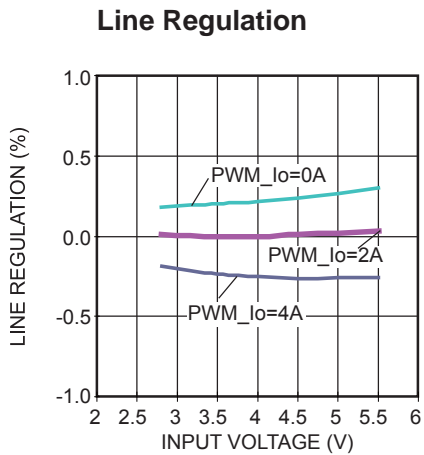
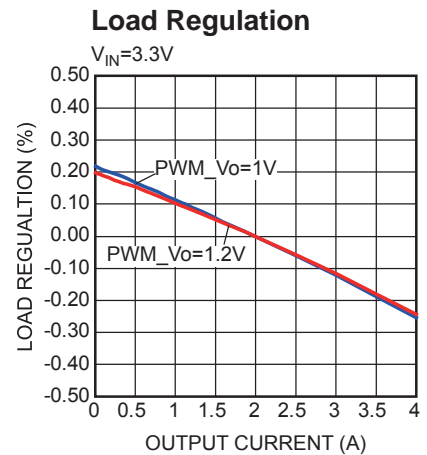
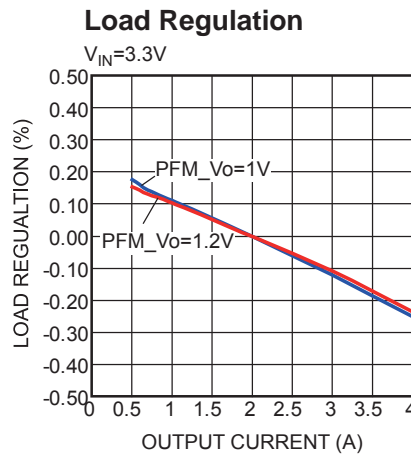
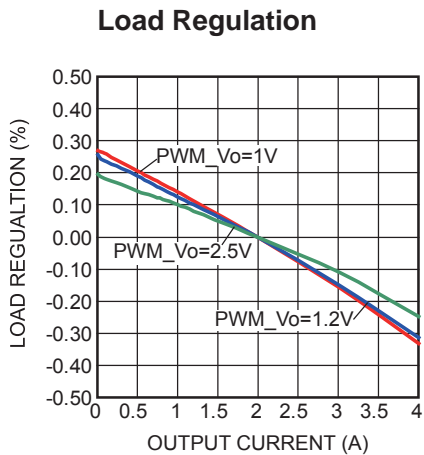
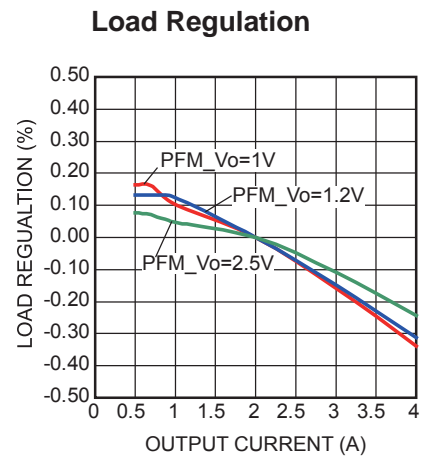
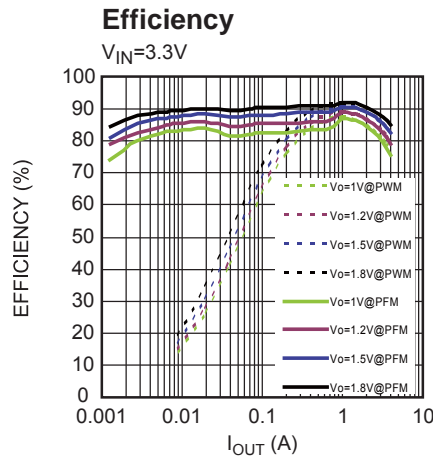
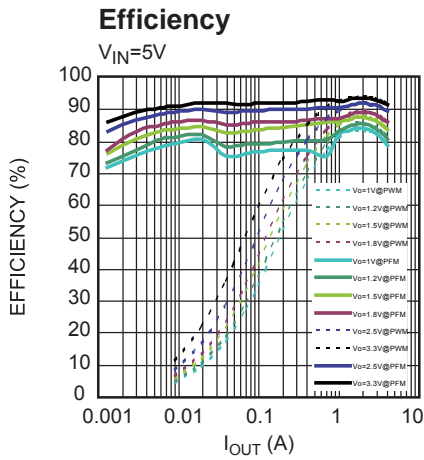

EVB TEST RESULTS *(continued)*

Performance waveforms are tested on the evaluation board.

$V_{IN}=5V$, $V_{OUT}=1.2V$, $T_A = 25^\circ C$, unless otherwise noted.

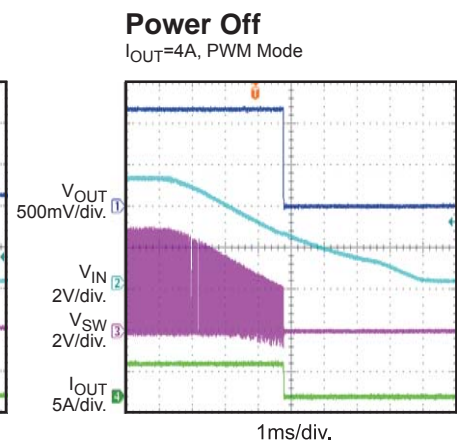
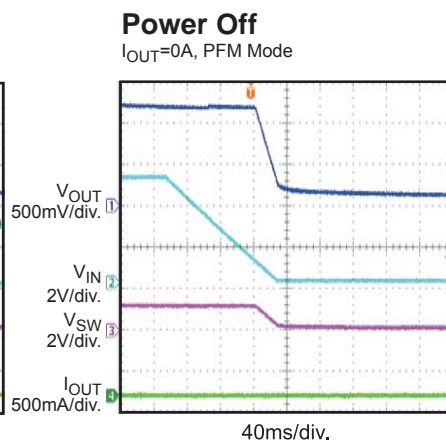
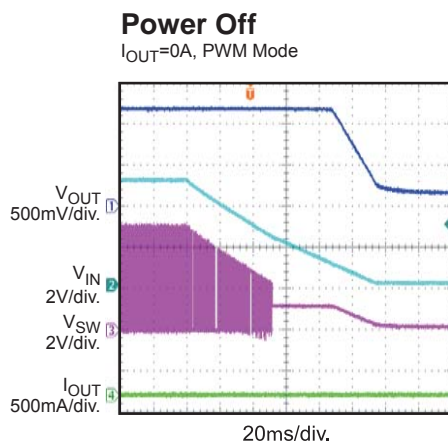
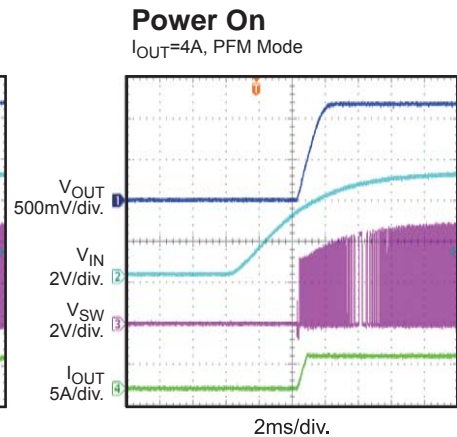
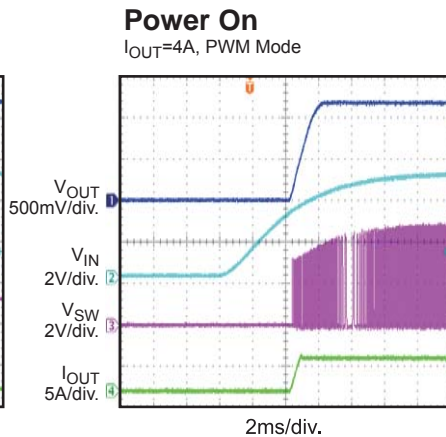
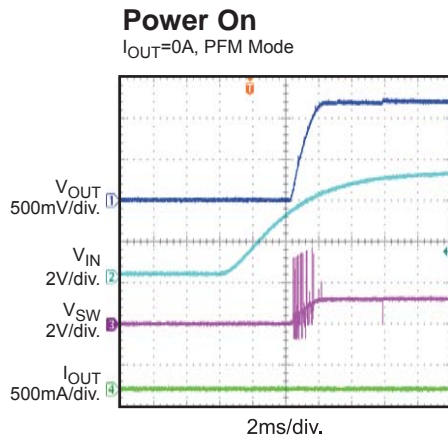
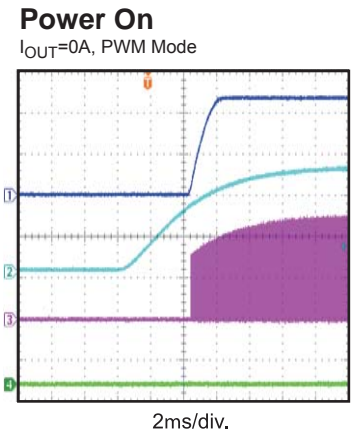
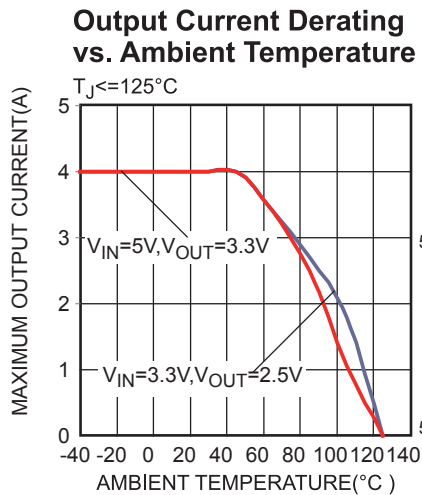
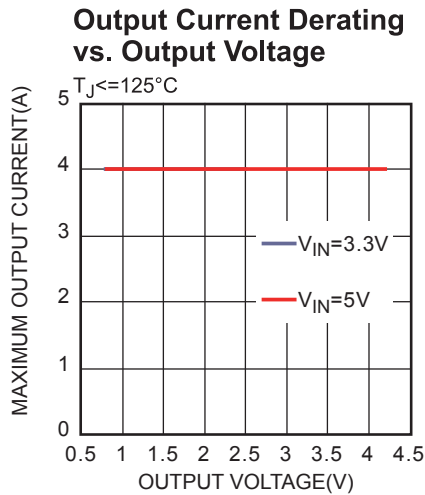

EVB TEST RESULTS *(continued)*

Performance waveforms are tested on the evaluation board.

$V_{IN}=5V$, $V_{OUT}=1.2V$, $T_A = 25^{\circ}C$, unless otherwise noted.

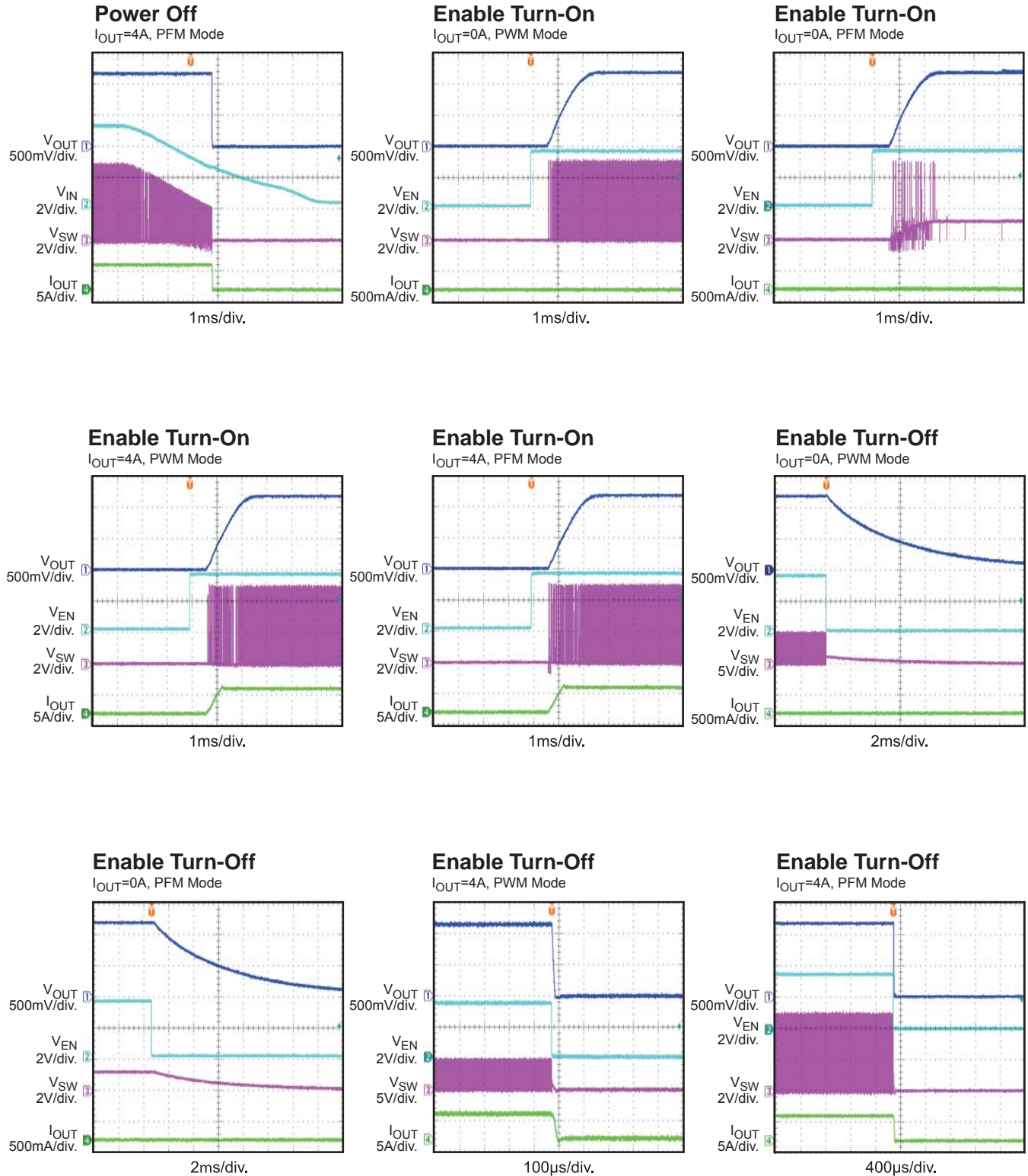

EVB TEST RESULTS *(continued)*

Performance waveforms are tested on the evaluation board.

$V_{IN}=5V$, $V_{OUT}=1.2V$, $T_A = 25^{\circ}C$, unless otherwise noted.

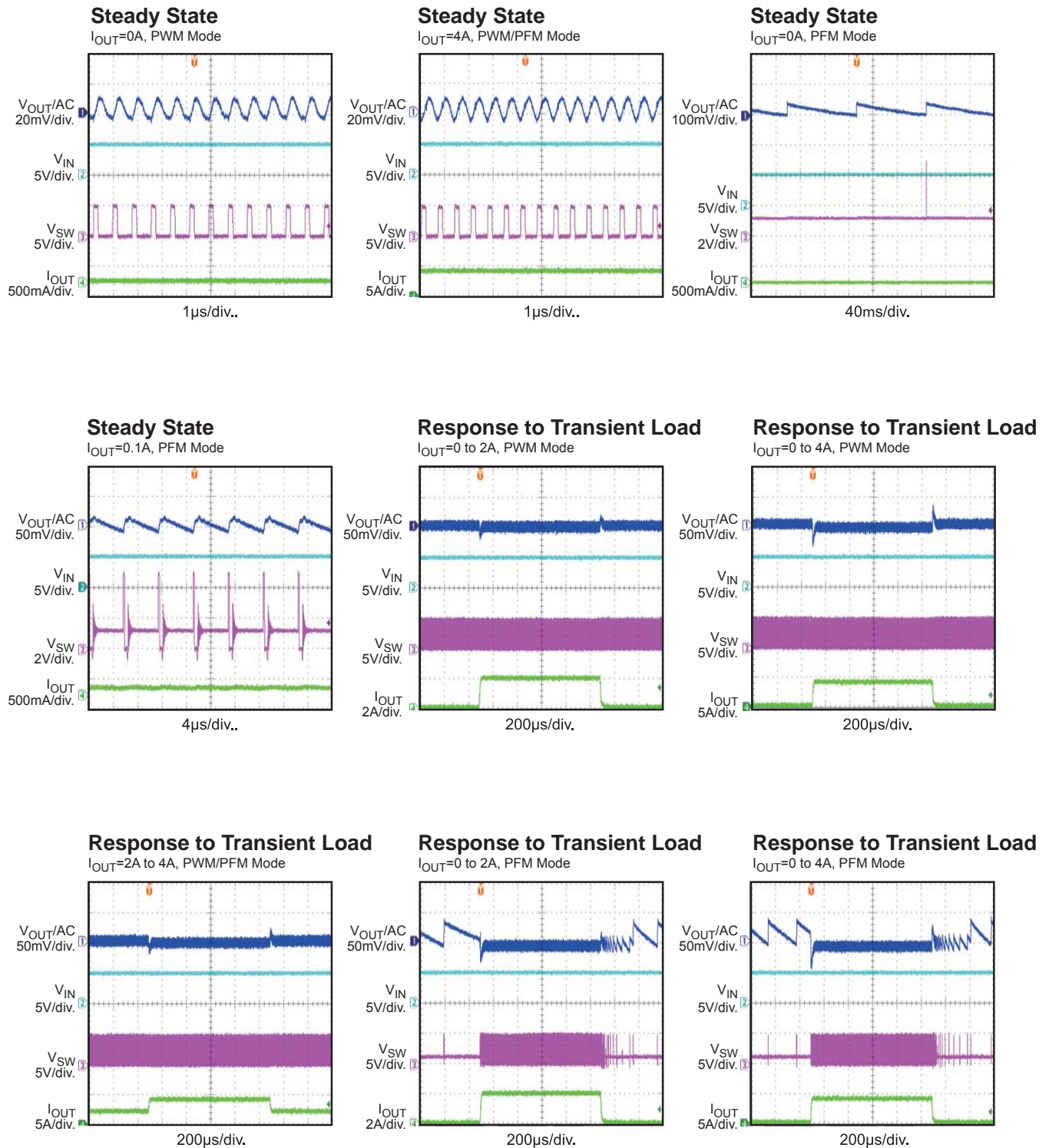

EVB TEST RESULTS *(continued)*

Performance waveforms are tested on the evaluation board.

$V_{IN}=5V$, $V_{OUT}=1.2V$, $T_A = 25^{\circ}C$, unless otherwise noted.

Power Good

$I_{OUT}=0A$

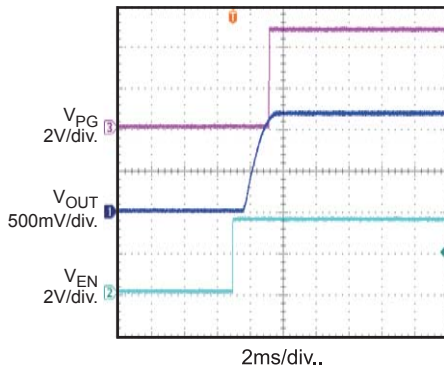

Power Bad

$I_{OUT}=0A$

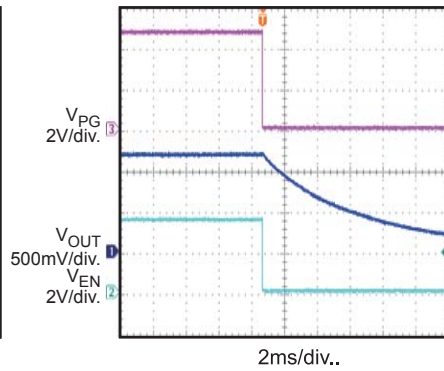

Output Short Entry

$I_{OUT}=0A$, PFM Mode

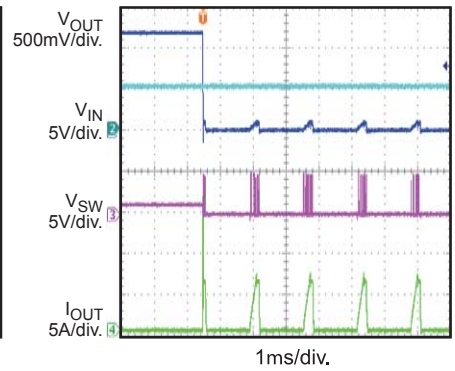

Output Short Recovery

$I_{OUT}=0A$, PFM Mode

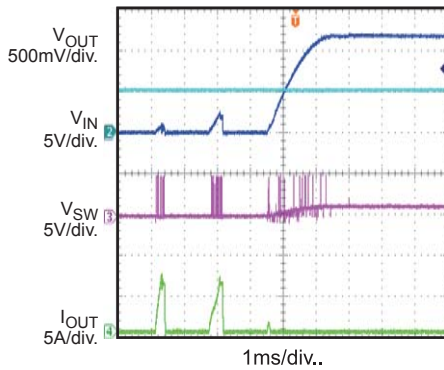

Output Short Entry

$I_{OUT}=0A$, PWM Mode

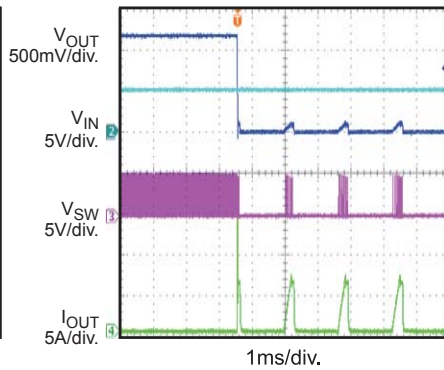

Output Short Recovery

$I_{OUT}=0A$, PWM Mode

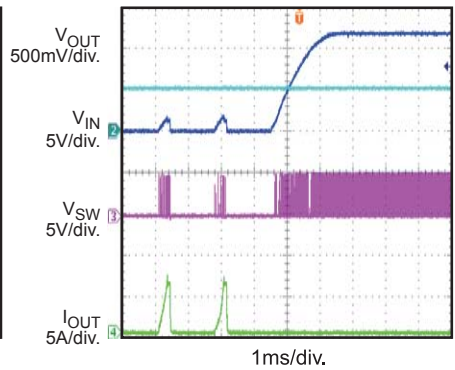

PRINTED CIRCUIT BOARD LAYER

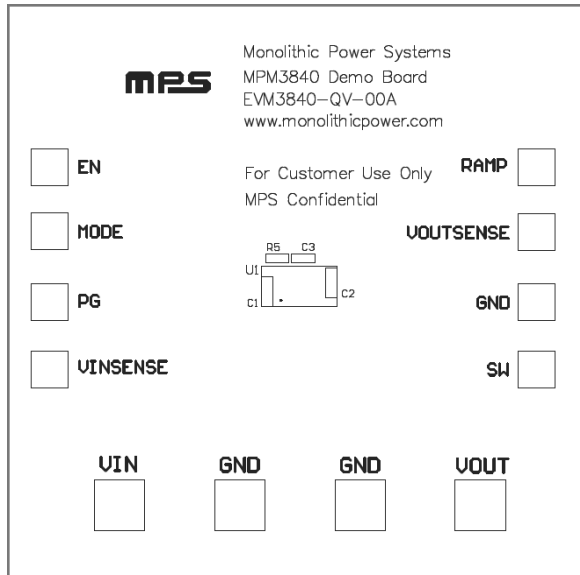

Figure 1: Top Silk Layer

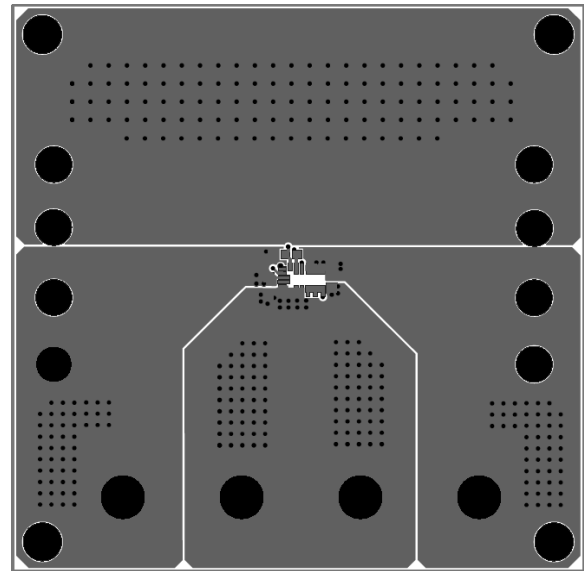

Figure 2: Top Layer

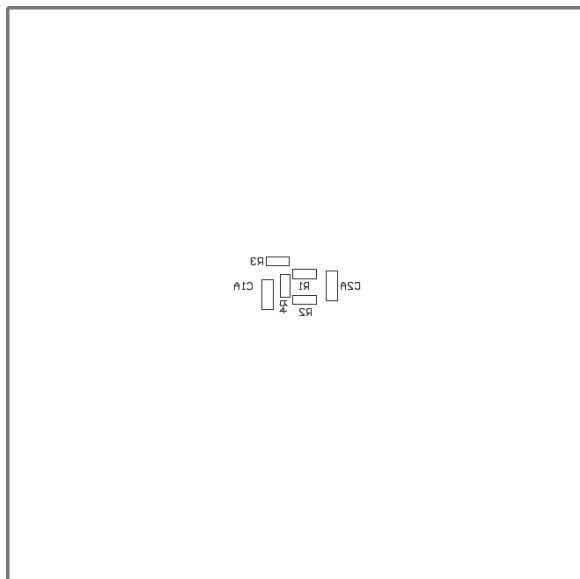

Figure 3: Bottom Silk Layer

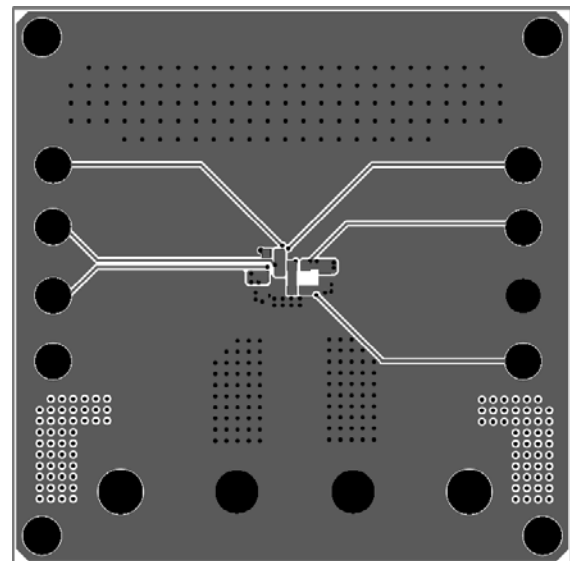

Figure 4: Bottom Layer

QUICK START GUIDE

The output voltage of this board is set externally which can be regulated as low as 0.6V by operating from +2.8V to +5.5V input. The default output voltage of this board is set to 1.2V.

1. Connect the positive and negative terminals of the load to the VOUT and GND pins, respectively.
2. Preset the power supply output between 2.8V and 5.5V, and then turn off the power supply.
3. Connect the positive and negative terminals of the power supply output to the VIN and GND pins, respectively.
4. Turn the power supply on. The board will automatically start up.

NOTICE: The information in this document is subject to change without notice. Please contact MPS for current specifications. Users should warrant and guarantee that third party Intellectual Property rights are not infringed upon when integrating MPS products into any application. MPS will not assume any legal responsibility for any said applications.