



EVM3690-30A-BF-00A

16V, Dual 18A, High-Efficiency,
Synchronous Step-Down Module
Evaluation Board

DESCRIPTION

The EVM3690-30A-BF-00A evaluation board is designed to demonstrate the capabilities of the MPM3690-30A, a fully integrated, high-efficiency, synchronous, dual 18A output current, step-down power module.

The MPM3690-30A adopts internally compensated constant-on-time (COT) control to provide fast transient response and ease loop

stabilization. The operating frequency can be set between 400kHz to 1MHz by connecting a resistor between f_{SET} and AGND. Refer to the MPM3690-30A datasheet for more detailed information.

It is recommended to read the datasheet for the MPM3690-30A prior to making any changes to the EVM3690-30A-BF-00A.

PERFORMANCE SUMMARY ⁽¹⁾

Specifications are at $T_A = 25^\circ\text{C}$, unless otherwise noted.

Parameters	Conditions	Value
Input voltage range (V_{IN})		3.2V to 16V ⁽²⁾
Output voltage (V_{OUT})	$V_{IN} = 3.2\text{V to }16\text{V}$, $I_{OUT} = 0\text{A to }18\text{A}$	1.2V
Maximum output current (I_{OUT})	$V_{IN} = 3.2\text{V to }16\text{V}$, $V_{OUT} = 1.2\text{V}$	18A
Full load efficiency ⁽³⁾	$V_{IN} = 12\text{V}$, $V_{OUT} = 1.2\text{V}$, $I_{OUT} = 18\text{A}$, $f_{SW} = 500\text{kHz}$	91.28%
Peak efficiency ⁽³⁾	$V_{IN} = 12\text{V}$, $V_{OUT} = 1.2\text{V}$, $I_{OUT} = 10\text{A}$, $f_{SW} = 500\text{kHz}$	92.96%
Default switching frequency		500kHz

Notes:

- 1) For different V_{IN} and V_{OUT} specifications with different output capacitors, the application circuit parameters may require changes.
- 2) If $V_{IN} < 4\text{V}$, an external 3.3V V_{CC} is required.
- 3) Only one channel is working; the other channel is off.

EVALUATION BOARD

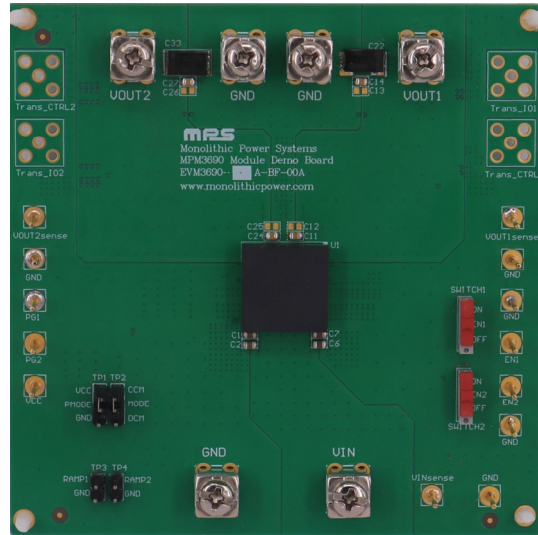

(LxWxH) 10cmx10cmx1.5cm

Board Number	MPS IC Number
EVM3690-30A-BF-00A	MPM3690GBF-30A

QUICK START GUIDE

The EVM3690-30A-BF-00A evaluation board is easy to set up and use to evaluate the performance of the MPM3690-30A. See Figure 1 on page 4 for the proper measurement equipment set-up, and follow the procedure below:

1. Preset the power supply (V_{IN}) between 4V and 16V, then turn off the power supply. ⁽⁴⁾
2. Connect the power supply terminals to:
 - a. Positive (+): V_{IN}
 - b. Negative (-): GND
3. Connect the load terminals (no initial load) to:
 - a. Positive (+): V_{OUT}
 - b. Negative (-): GND
4. After making the connections, turn on the power supply on. The board should automatically start up.
5. Check for the proper output voltage (V_{OUT}) between the $VOSENSE$ and $VOGNDSEN$ terminals.
6. Once the proper V_{OUT} is established, adjust the load within the operating range and measure the efficiency, output ripple voltage, and other parameters. ⁽⁵⁾
7. After completing all tests, adjust the load to 0A, then turn off the input power supply.

Notes:

- 4) Ensure that V_{IN} does not exceed 16V.
- 5) When measuring the output or input voltage ripple, do not use the long ground lead on the oscilloscope probe.

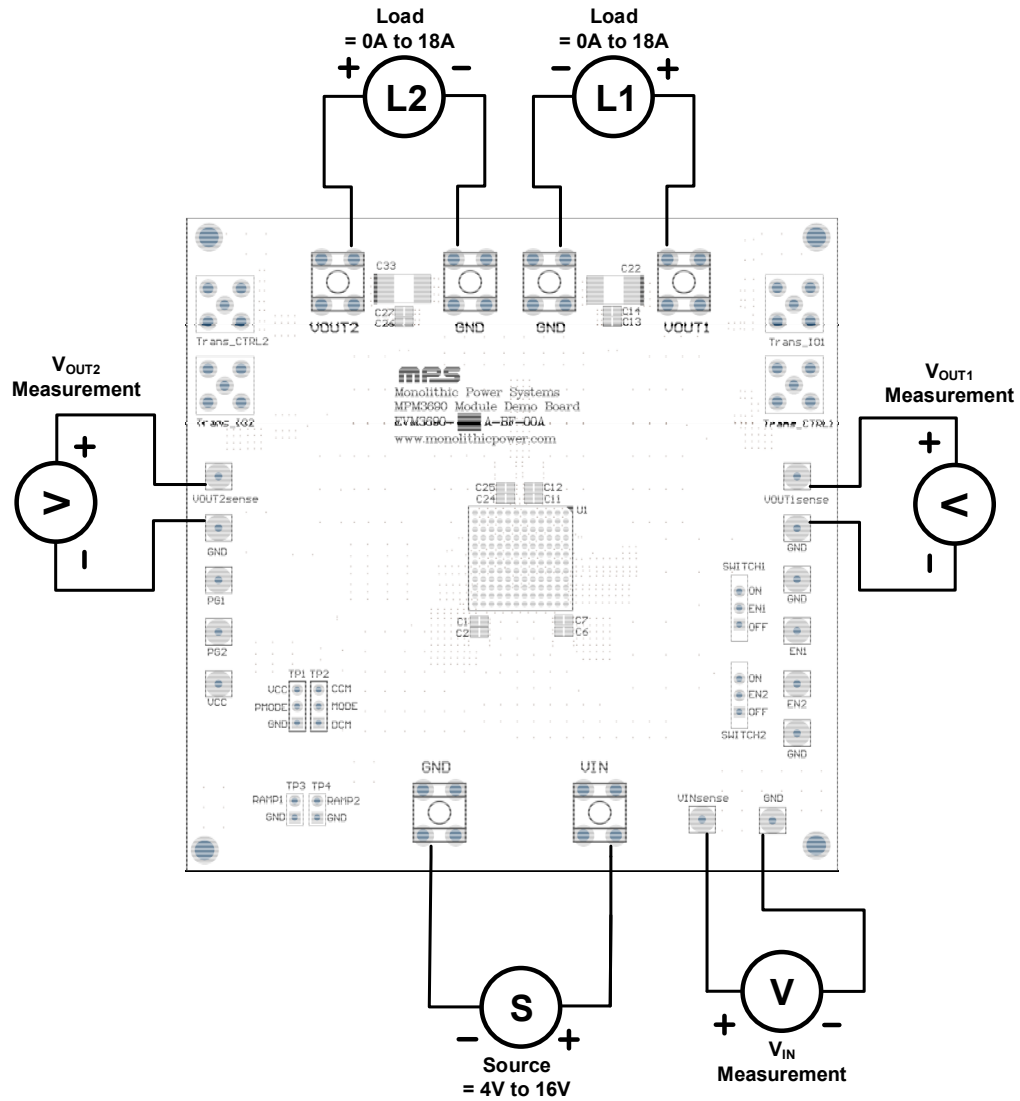

Figure 1: Proper Measurement Equipment Set-Up

EVALUATION BOARD SCHEMATIC

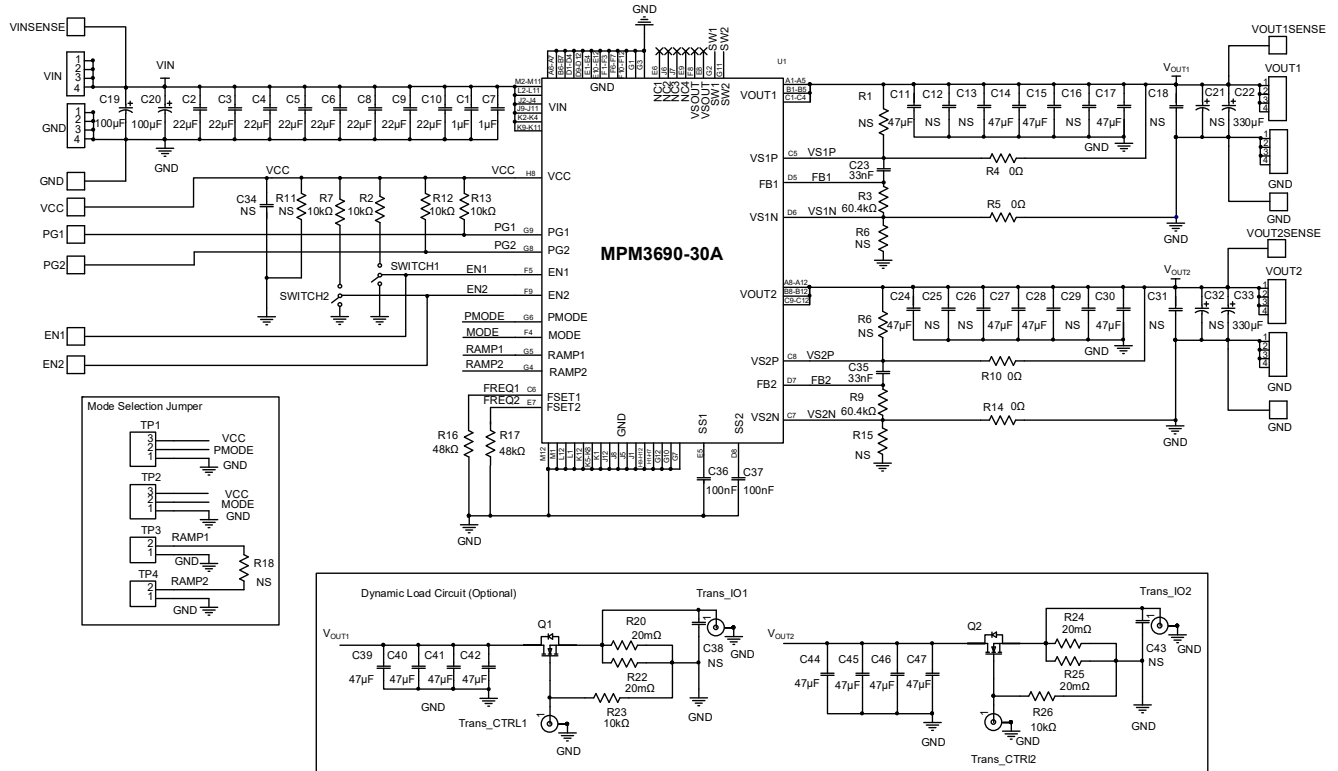

Figure 2: Evaluation Board Schematic

EVM3690-30A-BF-00A BILL OF MATERIALS

Qty	Ref	Value	Description	Package	Manufacturer	Manufacturer PN
2	C19, C20	100 μ F	Surface-mount polymer aluminum capacitor, 25V	SMD	Panasonic	25SVPF100M
8	C11, C14, C15, C17, C24, C27, C28, C30	47 μ F	Ceramic capacitor, 6.3V	0805	Murata	GRM21BR60J476 ME15L
8	C2, C3, C4, C5, C6, C8, C9, C10	22 μ F	Ceramic capacitor, 25V	0805	Murata	GRM21BR61E226 ME44L
2	C1, C7	1 μ F	Ceramic capacitor, 25V	0805	Murata	GRM219R71E105 KA88D
2	C36, C37	100nF	Ceramic capacitor, 50V	0603	Murata	GRM188R71E104 KA01D
2	C35, C23	33nF	Ceramic capacitor, 50V	0603	Würth	885012206092
4	R4, R5, R10, R14	0 Ω	Resistor, 1%	0603	Yageo	RC0603FR-070RL
2	R16, R17	48k Ω	Resistor, 1%	0603	Yageo	RC0603FR-0748KL
4	R2, R7, R12, R13	10k Ω	Resistor, 1%	0603	Yageo	RC0603FR-0710KL
2	R3, R9	60.4k Ω	Resistor, 1%	0603	Yageo	RC0603FR-0760K4L
2	SWITCH1, SWITCH2	500mA	Switch slide SPDT, 5V	10mmx 2.5mm	Würth	450301014042
2	C22, C33	220 μ F	Tantalum capacitor, 6.3V, 15m Ω	SMD	Panasonic	EEFCX0J221R
1	U1	MPM3690-30A	16V, dual 18A, step-down power module	BGA (16mmx 16mmx 5.18mm)	MPS	MPM3690GBF-30A

EVB TEST RESULTS

Performance curves and waveforms are tested on the evaluation board. $V_{IN} = 12V$, $V_{OUT1} = V_{OUT2} = 1.2V$, $f_{SW1} = f_{SW2} = 500kHz$, $T_A = 25^\circ C$, unless otherwise noted.

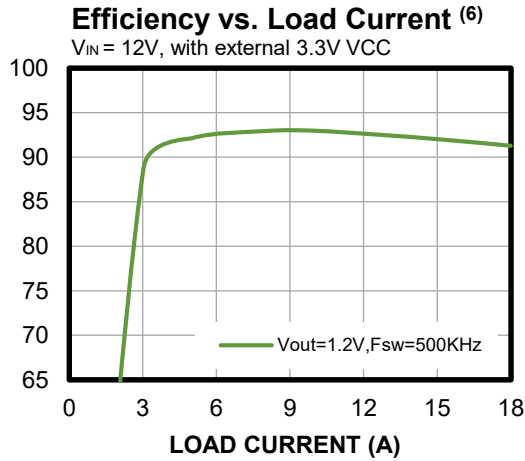

Thermal Performance

$I_{OUT1} = I_{OUT2} = 18A$, no forced airflow, $T_A = 28^\circ C$, $T_{CASE} = 73.9^\circ C$

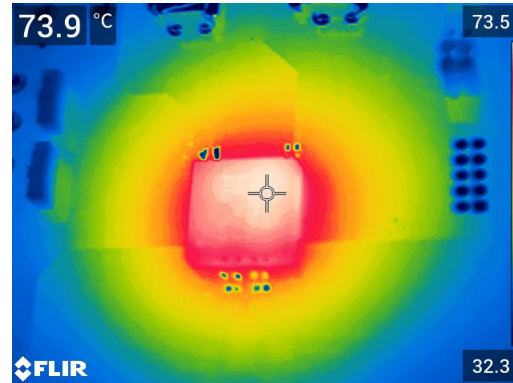

Note:

6) Only one channel is working; the other channel is off.

EVB TEST RESULTS *(continued)*

Performance curves and waveforms are tested on the evaluation board. $V_{IN} = 12V$, $V_{OUT1} = V_{OUT2} = 1.2V$, $f_{SW1} = f_{SW2} = 500kHz$, $T_A = 25^\circ C$, unless otherwise noted.

Steady State

$I_{OUT1} = I_{OUT2} = 18A$

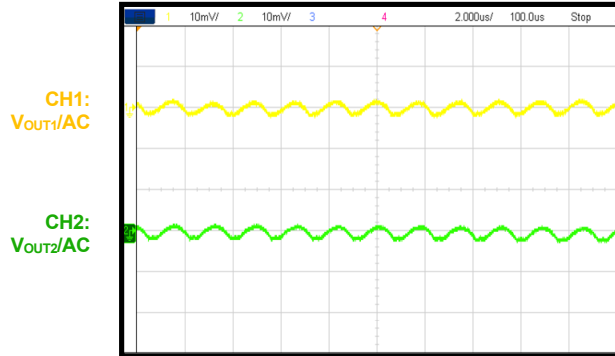

Load Transient Ripple

$I_{OUT1} = 0A$ to $9A$, slew rate = $10A/\mu s$

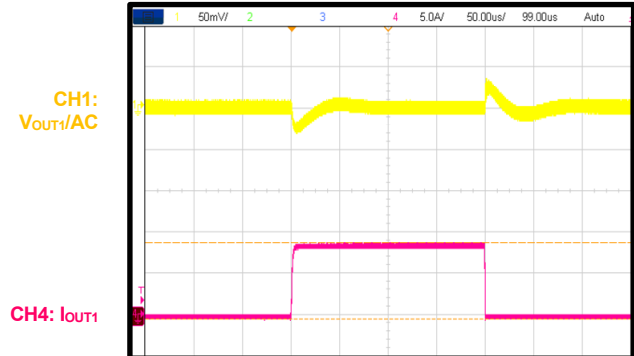

Start-Up through VIN

$I_{OUT1} = I_{OUT2} = 18A$

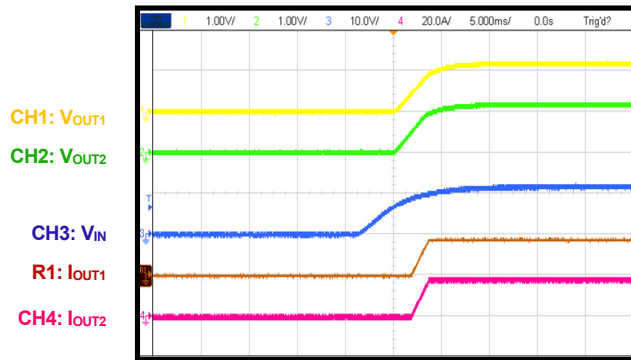

Shutdown through VIN

$I_{OUT1} = I_{OUT2} = 18A$

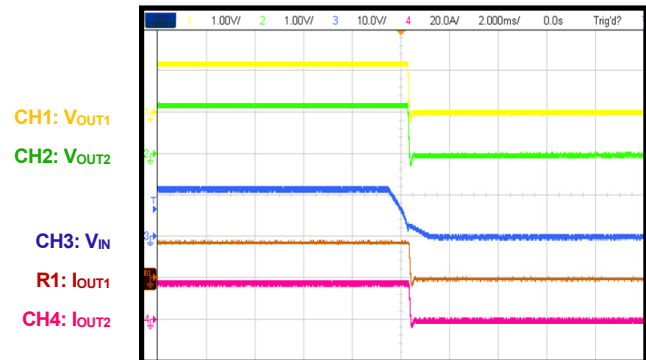

Start-Up through EN

$I_{OUT1} = 18A$

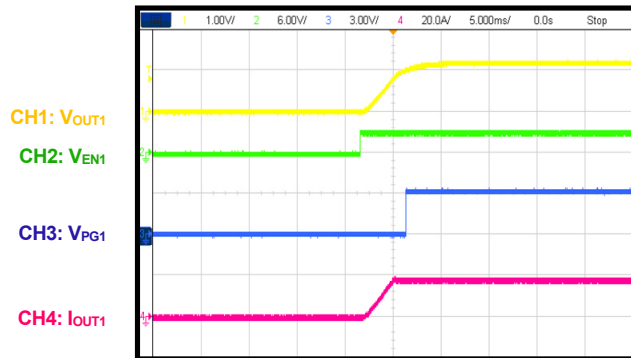

Shutdown through EN

$I_{OUT1} = 18A$

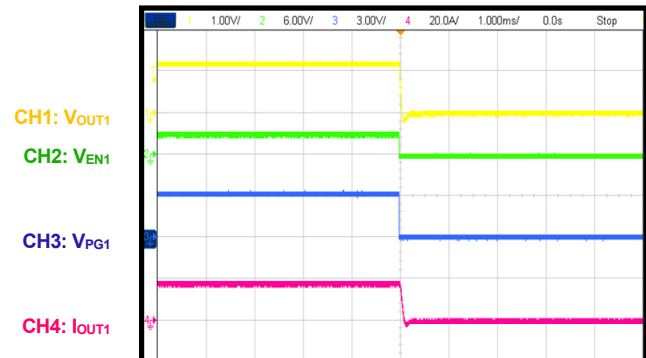

PCB LAYOUT

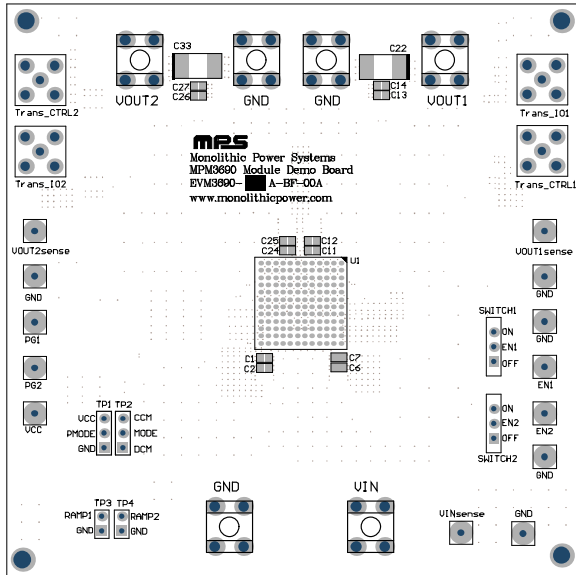

Figure 3: Top Silk

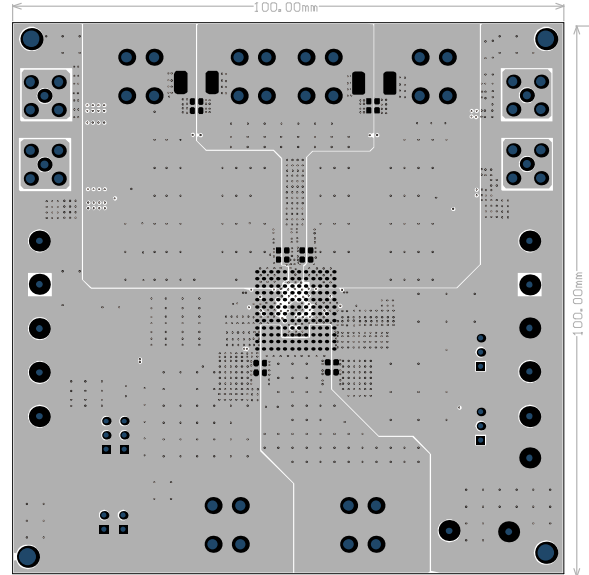

Figure 4: Top Layer

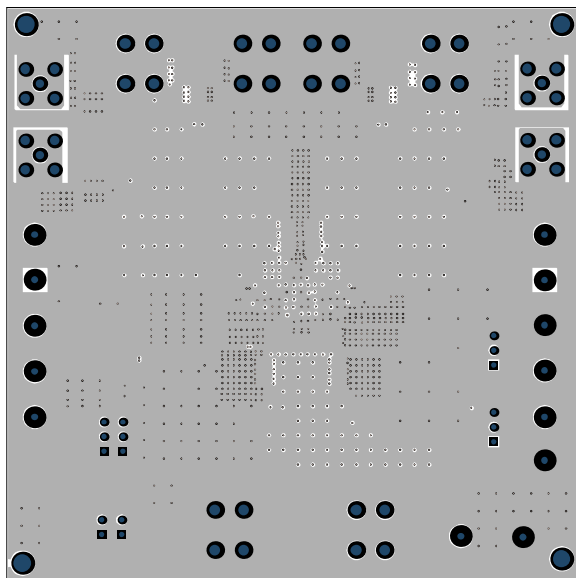

Figure 5: Mid-Layer 1

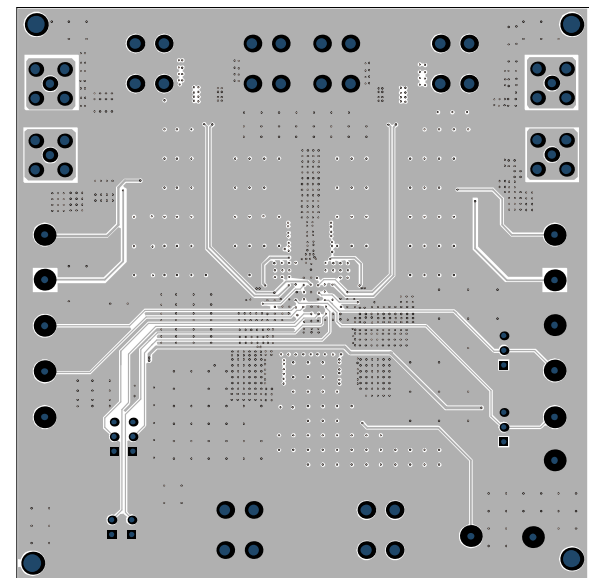

Figure 6: Mid-Layer 2

PCB LAYOUT (continued)

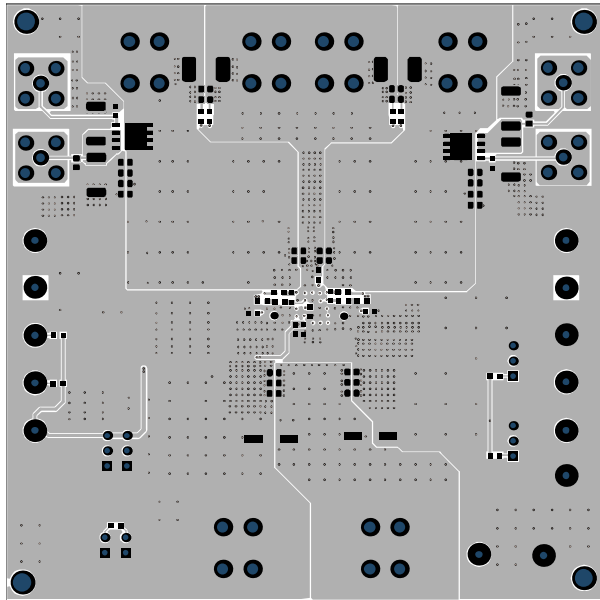

Figure 7: Bottom Layer

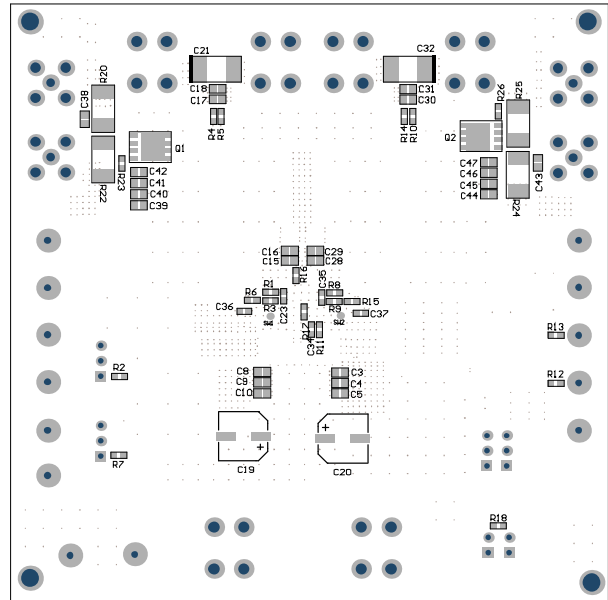

Figure 8: Bottom Silk



REVISION HISTORY

Revision #	Revision Date	Description	Pages Updated
1.0	08/23/2021	Initial Release	-

Notice: The information in this document is subject to change without notice. Please contact MPS for current specifications. Users should warrant and guarantee that third-party Intellectual Property rights are not infringed upon when integrating MPS products into any application. MPS will not assume any legal responsibility for any said applications.