



The Future of Analog IC Technology®

EVM3683-7-QN-01A

16V, 8A DC/DC Power Module
Evaluation Board

DESCRIPTION

The EVM3683-7-QN-01A Evaluation Board is designed to demonstrate the capabilities of MPS' MPM3683-7. The MPM3683-7 is an easy-to-use fully integrated peak 10A, continuous 8A step-down DC/DC power module. MPM3683-7 can deliver output current over a wide input supply voltage range with excellent load and line regulation.

The MPM3683-7 uses Constant-On-Time (COT) control to provide fast transient response and ease the loop stabilization.

The operating frequency is set easily to 600 kHz, 800 kHz, or 1000 kHz with the MODE configuration, allowing the MPM3683-7 frequency to remain constant regardless of the input/output voltages.

The MPM3683-7 is available in a space-saving QFN-28 (7mmx7mmx4mm) package.

ELECTRICAL SPECIFICATION

Parameter	Symbol	Value	Units
Input Voltage	V _{IN}	4-16	V
Output Voltage	V _{OUT}	1.2	V
Output Current	I _{OUT}	10	A

FEATURES

- Wide Input Voltage Range from 2.7 V:
 - 2.7 V to 16 V with External 3.3 V Bias
 - 4 V to 16 V with Internal Bias or External 3.3 V Bias
- Differential Output Voltage Remote Sense
- Peak 10A, Continuous 8A Output Current
- Adaptive Constant-on-Time (COT) for Ultrafast Transient Response
- Selectable Pulse Skip or Forced CCM Operation
- Output Voltage Discharge
- Pre-Bias Start-Up
- Selectable Switching Frequency from 600kHz, 800 kHz, and 1000 kHz
- Non-Latch OCP, UVP, UVLO, Thermal Shutdown, and OVP.
- Output Adjustable from 0.6 V to up to 5.5 V Max.
- QFN-28 (7mm x 7mm x 4mm) package

APPLICATIONS

- Telecom and Networking Systems
- Base Stations
- Industrial Systems
- Servers & Storage

All MPS parts are lead-free, halogen-free, and adhere to the RoHS directive. For MPS green status, please visit the MPS website under Quality Assurance. "MPS" and "The Future of Analog IC Technology" are registered trademarks of Monolithic Power Systems, Inc.

EVM3683-7-QN-01A DEMO BOARD



(L x W x H) 6.4cm x 6.4cm x 1.3cm

Board Number	MPS IC Number
EVM3683-7-QN-01A	MPM3683-7

Efficiency

V_{IN}=4V/12V/16V, V_{OUT}=1.2V, I_{OUT}=0-10A

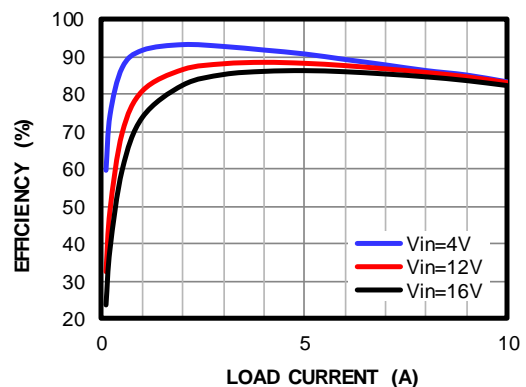

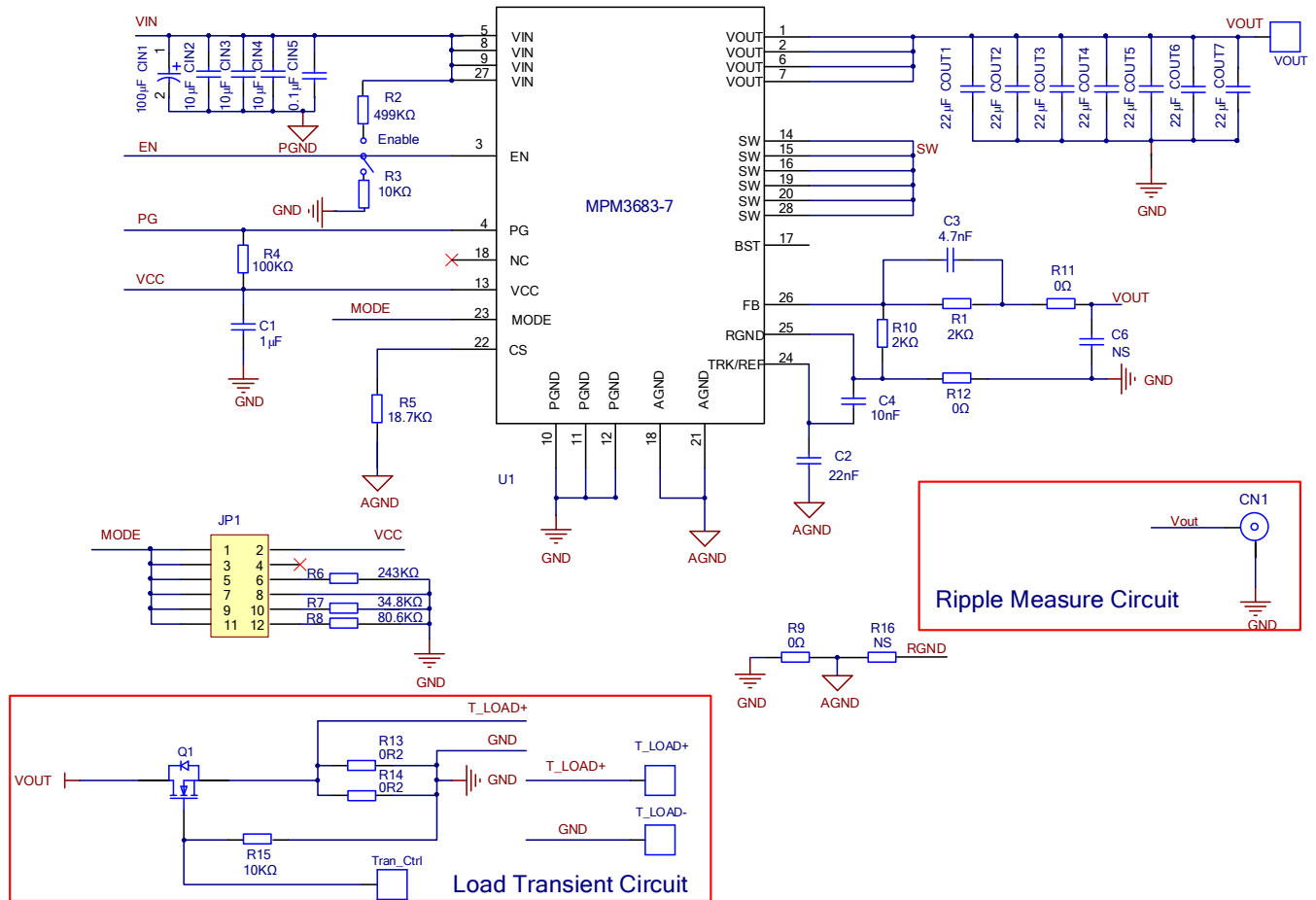
EVM3683-7-QN-01A SCHEMATIC

Vin=12V, Vout=1.2V

EVM3683-7-QN-01A BOM

Qty	RefDes	Value	Description	Package	Manufacturer	Manufacturer_P/N
1	CIN1	100µF	100µF/35V	SMD	NIPPON CHEMI-CON	EMZJ350ADA101MF80G
3	CIN2,CIN 3.CIN4	10µF	Ceramic Cap.,25V,X7S	0805	Murata	GRM21BC71E106KE11L
1	CIN5	100nF	Ceramic Cap.,25V,X7R	0603	Murata	GRM188R71E104KA01D
1	C1	1µF	Ceramic Cap.,25V,X7R	0603	Murata	GRM188R71E105KA12D
1	C2	22nF	Ceramic Cap.,25V,X7R	0603	WE	885012206067
1	C3	4.7nF	Ceramic Cap.,50V,X7R	0603	Murata	GRM188R71H472KA01D
1	C4	10nF	Ceramic Cap.,25V,X7R	0603	Murata	GRM188R71E103KA01D
7	COUT1. COUT2. COUT3. COUT4. COUT5. COUT6. COUT7	22µF	Ceramic Cap.,6.3V,X5R	0805	WE	885012107005
2	R1.R10	2k	Film Res,1%,0603,2k	0603	YAGEO	RC0603FR-072KL
1	R2	499k	Film Res,1%,0603,499k	0603	YAGEO	RC0603FR-07499KL
1	R4	100k	Film Res,1%,0603,100k	0603	YAGEO	RC0603FR-07100KL
2	R3.R15	10k	Film Res,1%,0603,10k	0603	YAGEO	RC0603FR-0710KL
1	R5	18K7	Film Res,1%,0603,18k7	0603	YAGEO	RC0603FR-0718K7L
1	R6	243k	Film Res,1%,0603,243k	0603	YAGEO	RC0603FR-07243KL
1	R7	34K8	Film Res,1%,0603,34k8	0603	YAGEO	RC0603FR-0734K8L
1	R8	80K6	Film Res,1%,0603,80k6	0603	YAGEO	RC0603FR-0780K6L
3	R9.R11. R12	0R	Film Res,1%,0603,0R	0603	YAGEO	RC0603FR-070RL
2	R13.R14	0R2	Film Res,1%,2512,0R2	2512	YAGEO	RC2512FR-00R2L
1	Q1	MOS				AM7432N

EVB TEST RESULTS

$V_{IN}=12V$, $V_{OUT}=1.2V$, $T_A = +25^{\circ}C$, $CCM=1000k$, unless otherwise noted.

Efficiency

$V_{IN}=4V/12V/16V, V_{OUT}=1.2V, I_{OUT}=0-10A$

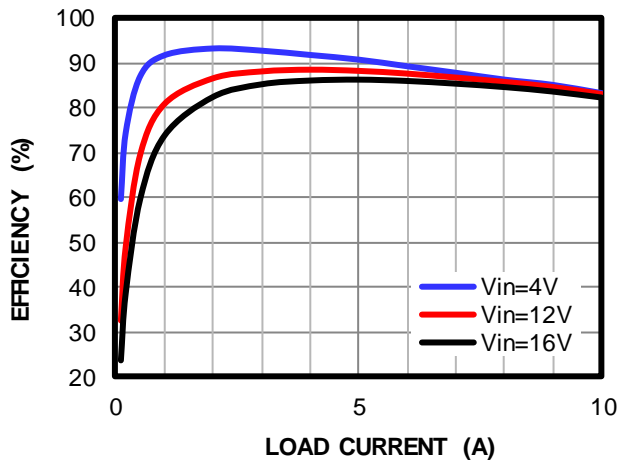

Line Regulation

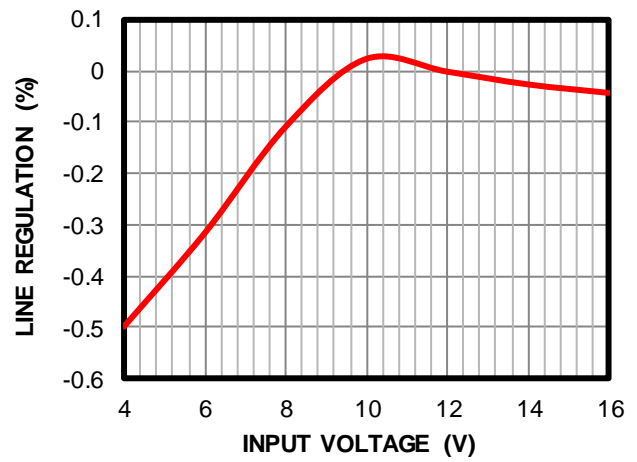

Load Regulation

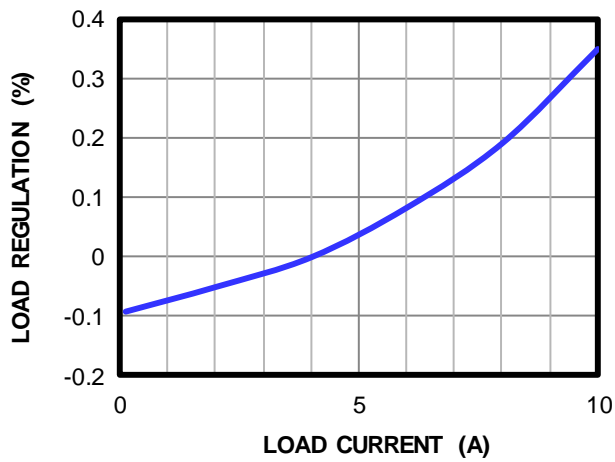

EVB TEST RESULTS (continued)

$V_{IN}=12V$, $V_{OUT}=1.2V$, $T_A=+25^{\circ}C$, CCM=1000k, unless otherwise noted.

Vo Ripple

$I_{OUT}=0A$

CH1:
 V_{OUT}/AC
5mV/div.

CH4: I_{OUT}
5A/div.

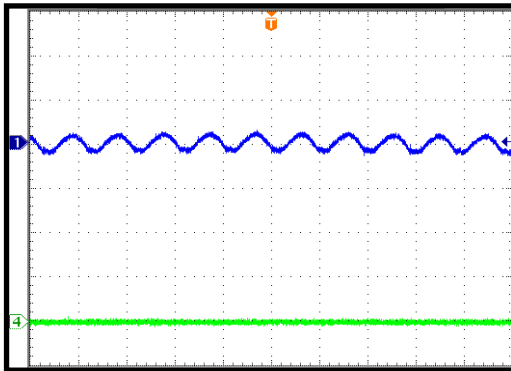

1.0 μ s/div.

Vo Ripple

$I_{OUT}=10A$

CH1:
 V_{OUT}/AC
5mV/div.

CH4: I_{OUT}
5A/div.

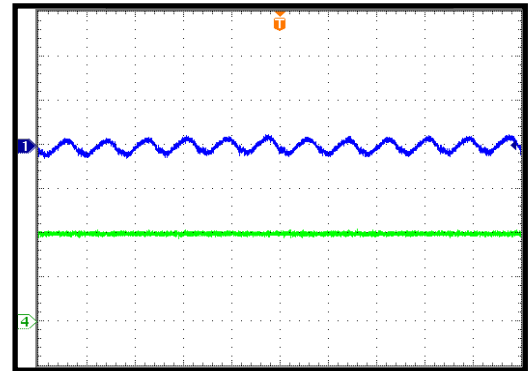

1.0 μ s/div.

Vin Start-Up Through Input Voltage

$I_{OUT}=0A$

CH1: V_{OUT}
1V/div.

CH2: V_{IN}
5V/div.

CH3: V_{SW}
5V/div.

CH4: I_{OUT}
10A/div.

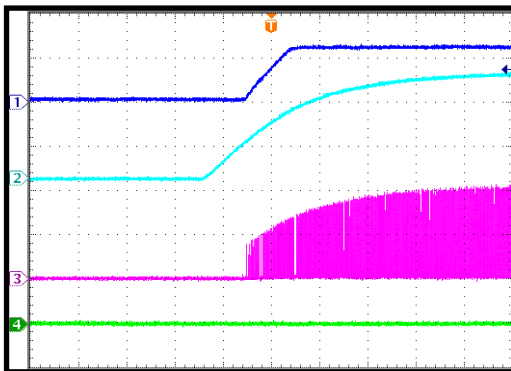

2ms/div.

Vin Start-Up Through Input Voltage

$I_{OUT}=10A$

CH1: V_{OUT}
1V/div.

CH2: V_{IN}
5V/div.

CH3: V_{SW}
5V/div.

CH4: I_{OUT}
10A/div.

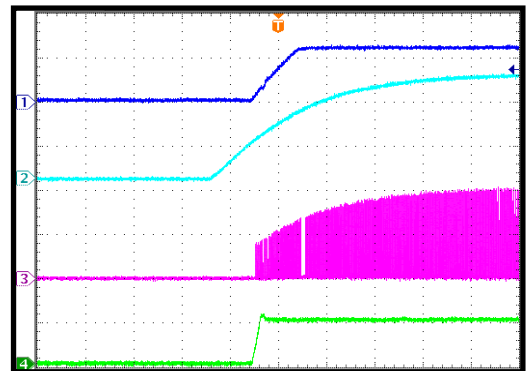

2ms/div.

Vin Shutdown Through Input Voltage

$I_{OUT}=0A$

CH1: V_{OUT}
1V/div.

CH2: V_{IN}
5V/div.

CH3: V_{SW}
5V/div.

CH4: I_{OUT}
10A/div.

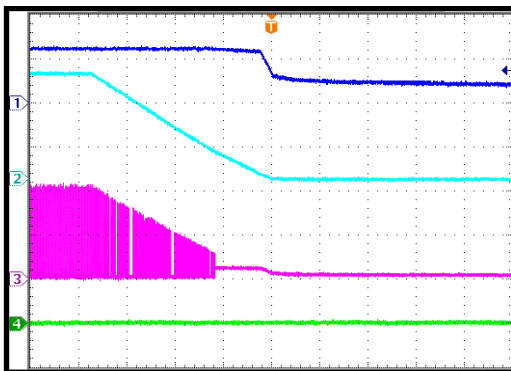

20ms/div.

Vin Shutdown Through Input Voltage

$I_{OUT}=10A$

CH1: V_{OUT}
1V/div.

CH2: V_{IN}
5V/div.

CH3: V_{SW}
5V/div.

CH4: I_{OUT}
10A/div.

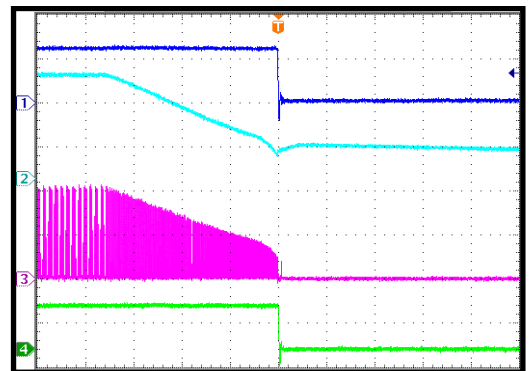

1ms/div.

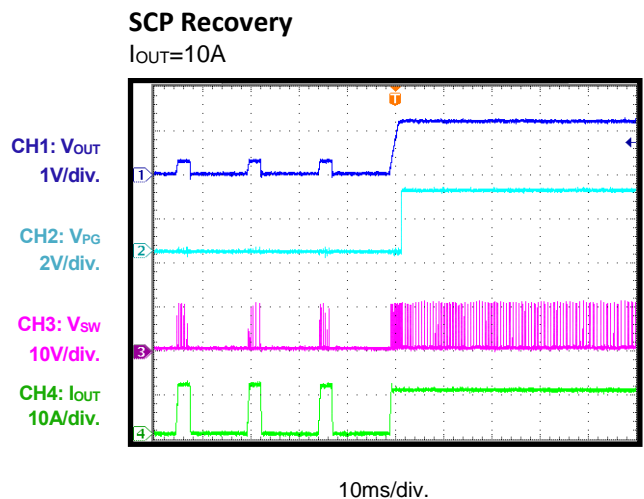
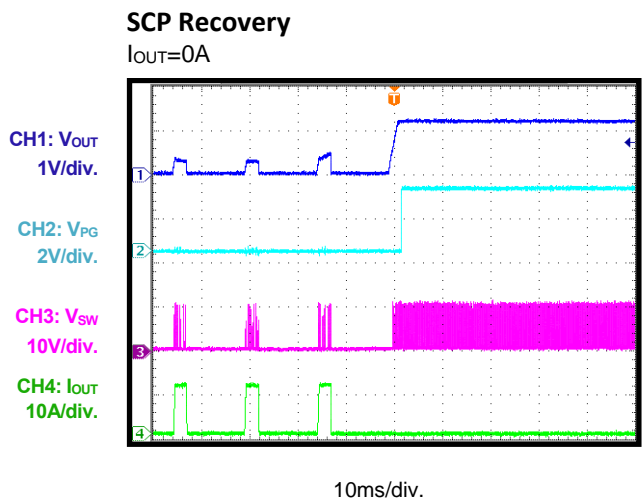
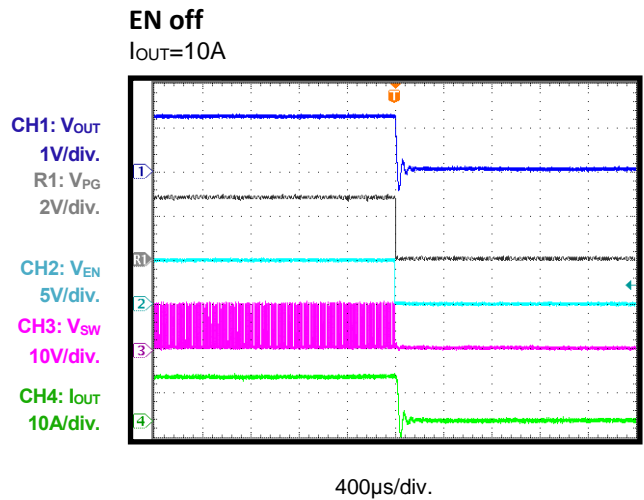
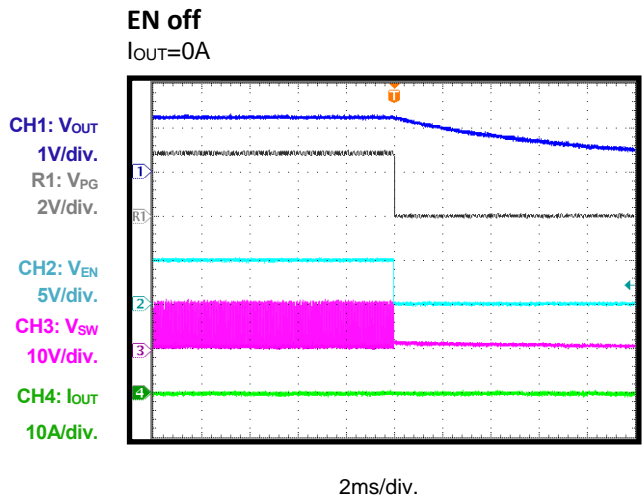
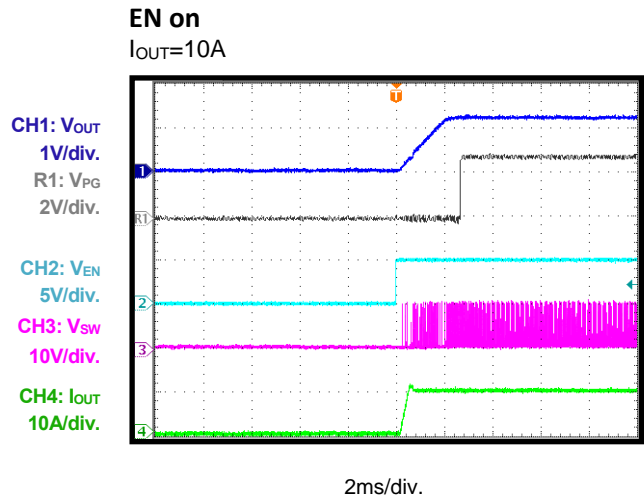
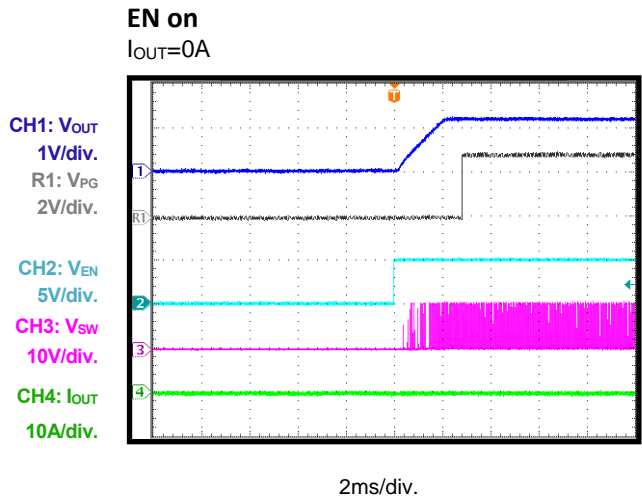
EVB TEST RESULTS (continued)
 $V_{IN} = 12V$, $V_{OUT} = 1.2V$, $T_A = +25^{\circ}C$, CCM=1000k, unless otherwise noted.

EVB TEST RESULTS (continued)
 $V_{IN}=12V$, $V_{OUT}=1.2V$, $T_A=+25^{\circ}C$, $CCM=1000k$, unless otherwise noted.

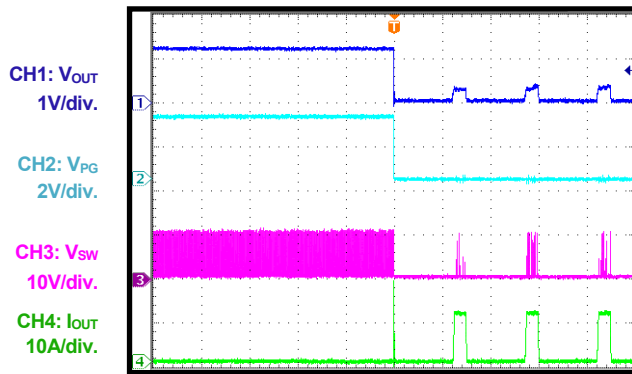
SCP Entry
 $I_{OUT}=0A$

10ms/div.

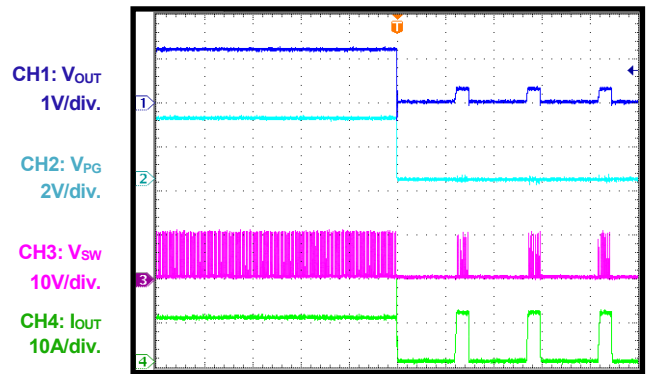
SCP Entry
 $I_{OUT}=10A$

10ms/div.

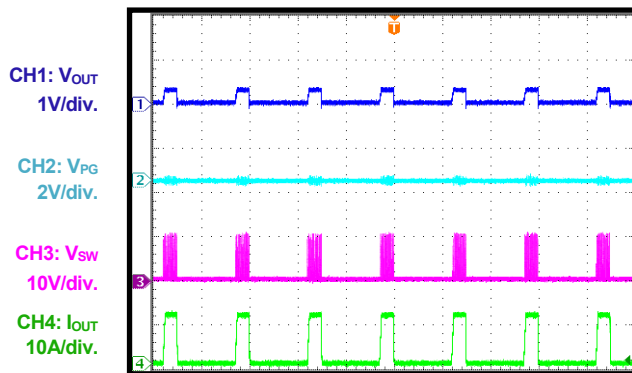
SCP Steady State

10ms/div.

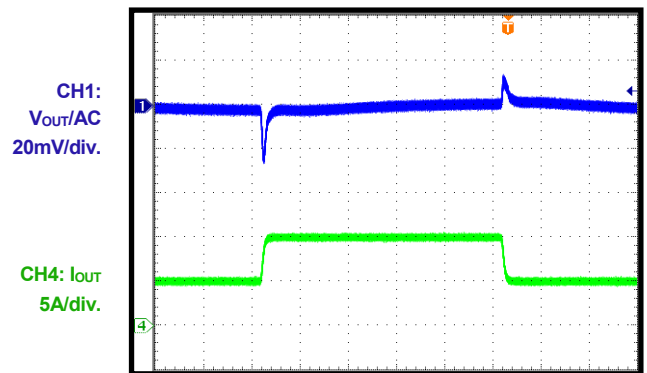
Load Transient
 $I_{OUT}=5A-10A, 1A/\mu s$

100µs/div.

PRINTED CIRCUIT BOARD LAYOUT (continued)

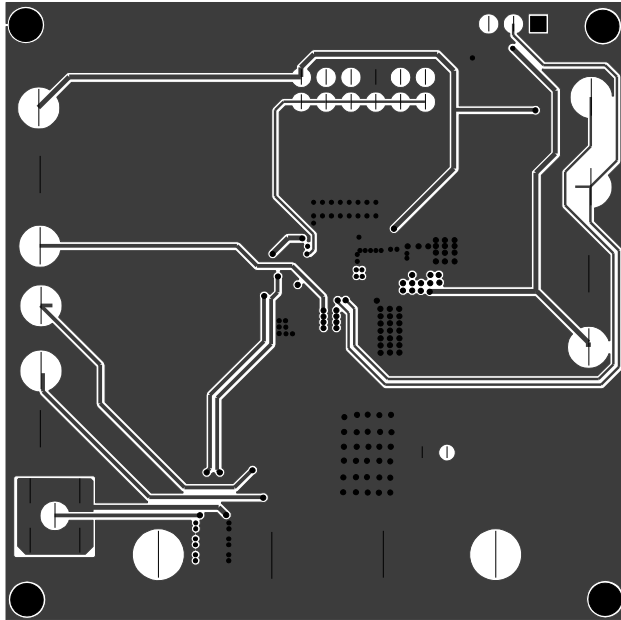

Figure 5-Inner2 Layer

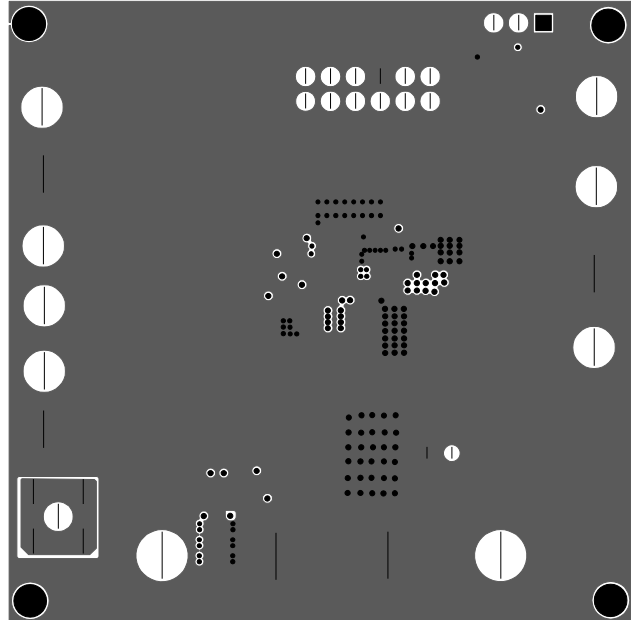

Figure 6-Inner3 Layer

QUICK START:

1. Connect the positive and negative terminals of the load to the VOUT and GND pins, respectively.
2. Preset the power supply output between 4V and 16V, and then turn off the power supply.
3. Connect the positive and negative terminals of the power supply output to the VIN and GND pins, respectively.
4. Before turn the power supply, choose the suitable Fsw by Jumper connector (JP1).
5. Turn the power supply on. The board will automatically start up.

NOTICE: The information in this document is subject to change without notice. Users should warrant and guarantee that third party Intellectual Property rights are not infringed upon when integrating MPS products into any application. MPS will not assume any legal responsibility for any said applications.