



# EVL8017-L-00B

## IEEE 802.3af-Compliant, PoE PD Solution with PSR Flyback Converter Evaluation Board

### DESCRIPTION

The EVL8017-L-00B is an evaluation board designed to demonstrate the capabilities of the MP8017, an integrated, IEEE 802.3af-compatible, power over Ethernet (PoE) powered device (PD). The device also includes a PD interface and a flyback power converter.

The MP8017 provides a front-end solution for small-sized, 13W, isolated PoE applications. The PD interface features IEEE 802.3af capability. The MP8017 flyback converter is

specifically designed for active-clamp, primary-side regulation (PSR) in a flyback topology, which supports small size and high efficiency. The MP8017 can also be set to secondary-side regulation (SSR) for active-clamp flyback topologies.

It is recommended to read the MP8017 datasheet prior to making any changes to the EVL8017-L-00B.

### PERFORMANCE SUMMARY

Specifications are at  $T_A = 25^\circ\text{C}$ , unless otherwise noted.

Parameters	Conditions	Value
Input voltage ( $V_{IN}$ ) range		37V to 57V
Output voltage ( $V_{OUT}$ )	$V_{IN} = 37\text{V to }57\text{V}$ , $I_{OUT} = 0\text{A to }2.4\text{A}$	5V
Maximum output current ( $I_{OUT}$ )	$V_{IN} = 37\text{V to }57\text{V}$	2.4A
Full load efficiency	$V_{IN} = 48\text{V}$ , $V_{OUT} = 5\text{V}$ , $I_{OUT} = 2.4\text{A}$ , $f_{SW} = 500\text{kHz}$	85.2%
Switching frequency ( $f_{SW}$ )		500kHz

 Optimized Performance with MPS Inductor MPL-AT2512 Series

### EVALUATION BOARD

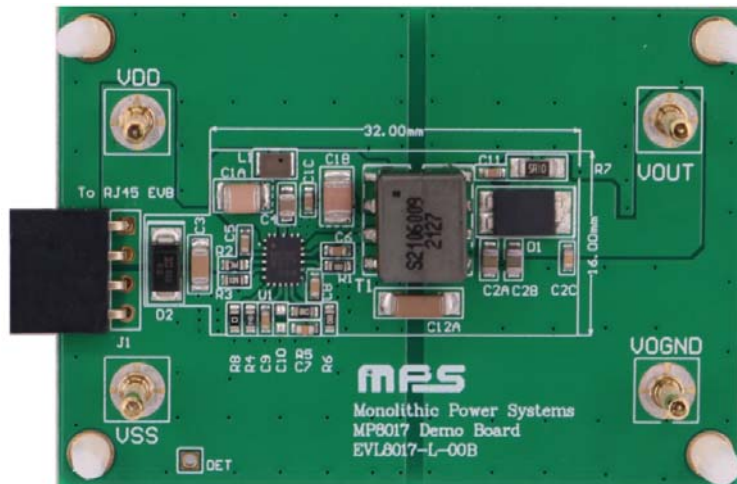

**LxWxH (6cmx4.2cmx1.2cm)**  
**2 Layers, 1oz/1oz**

Board Number	MPS IC Number
EVL8017-L-00B	MP8017GL

## QUICK START GUIDE

The EVL8017-L-00B evaluation board is easy to set up and use to evaluate the performance of the MP8017. For proper set-up, refer to Figure 1 on page 2 and Figure 2 on page 3. The EVL8017-L-00B has two start-up methods:

### Method 1:

Figure 1 shows the connection method using a DC source supply set-up.

1. Preset the power supply ( $V_{IN}$ ) between 40V and 57V, then turn off the power supply. <sup>(1)</sup>
2. Connect the power supply terminals to:
  - a. Positive (+): VDD
  - b. Negative (-): VSS
3. Connect the load terminals to:
  - a. Positive (+): VOUT
  - b. Negative (-): VOGND
4. After making the connections, turn on the power supply.
5. Once VDD is turned on, the MP8017 should be enabled on the evaluation board.

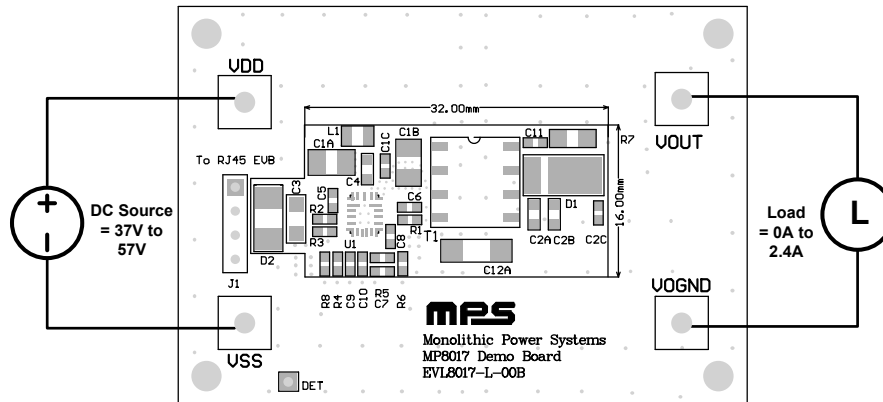
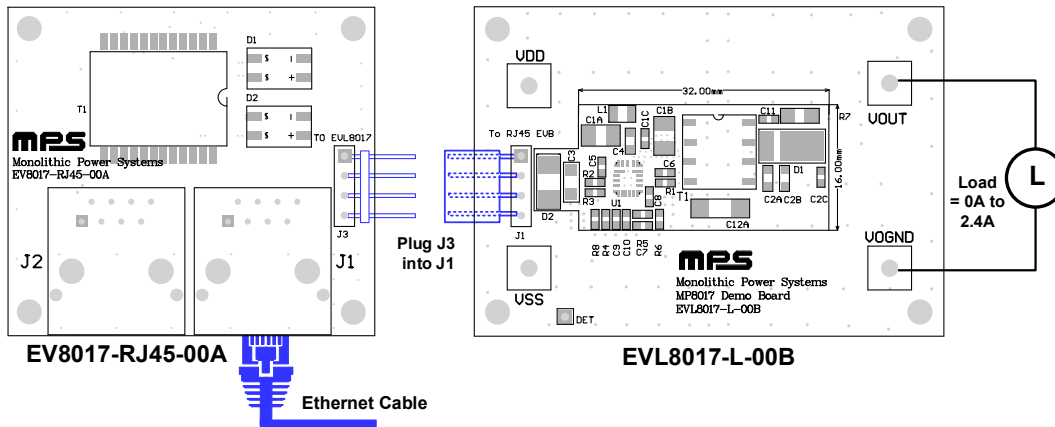

**Figure 1: DC Source Supply Set-Up**

### Method 2:

Figure 2 on page 3 shows the connection method using an Ethernet cable supply set-up.

1. Connect J1 on the EVL8017-L-00B to J3 on the EV8017-RJ45-00A. <sup>(2)</sup>
2. Connect the load terminals to:
  - a. Positive (+): VOUT
  - b. Negative (-): VOGND
3. Use the Ethernet cable to connect PSE power to J1 on the EV8017-RJ45-00A. The EVL8017-L-00B should start up automatically.

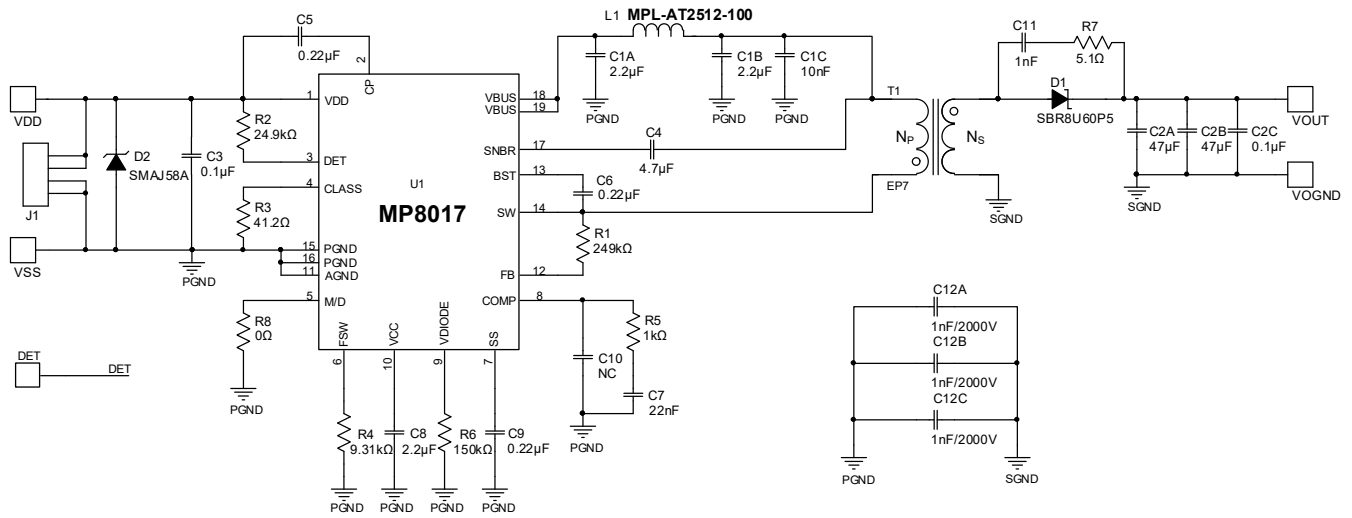

**Figure 2: Ethernet Cable Supply Set-Up**

**Notes:**

- 1) After start-up, the board can operate at a  $V_{IN}$  as low as 37V.
- 2) Contact an MPS FAE regarding the EV8017-RJ45-00A, an RJ45 connection board with an Ethernet cable.

## EVALUATION BOARD SCHEMATIC



**Figure 3: Evaluation Board Schematic**

**EVL8017-L-00B BILL OF MATERIALS**

Qty	Ref	Value	Description	Package	Manufacturer	Manufacturer PN
1	L1	10 $\mu$ H	Inductor, I <sub>SAT</sub> = 1.7A, DCR = 355m $\Omega$	SMD	MPS	MPL-AT2512-100
2	C1A, C1B	2.2 $\mu$ F	Ceramic capacitor, 100V, X7R	1210	Murata	GRM319R72A225KA01D
1	C1C	10nF	Ceramic capacitor, 100V, X7R	0603	Murata	GRM188R72A103KA01D
2	C2A, C2B	47 $\mu$ F	Ceramic capacitor, 10V, X7R	0805	Murata	GRM21BR71A476KA01D
1	C2C	0.1 $\mu$ F	Ceramic capacitor, 25V, X7R	0603	Murata	GRM188R71E104KA01D
1	C3	0.1 $\mu$ F	Ceramic capacitor, 100V, X7R	1206	Murata	GRM319R72A104KA01D
1	C4	4.7 $\mu$ F	Ceramic capacitor, 50V, X7R	0805	TDK	CGA4J1X7R1H475K
3	C5, C6, C9	0.22 $\mu$ F	Ceramic capacitor, 10V, X7R	0603	Murata	GRM188R71A224KA01D
1	C7	22nF	Ceramic capacitor, 10V, X7R	0603	Murata	GRM188R71A223KA01D
1	C8	2.2 $\mu$ F	Ceramic capacitor, 10V, X7R	0603	Murata	GRM188R71A225KA01D
1	C10	NC				
1	C11	1nF	Ceramic capacitor, 100V, X7R	0603	Murata	GRM188R72A102KA01D
3	C12A, C12B, C12C	1nF	Ceramic capacitor, 2000V, X7R	1808	Murata	GR442QR73D102KW01L
1	R1	249k $\Omega$	Film resistor, 1%	0603	Yageo	RC0603FR-07249KL
1	R2	24.9k $\Omega$	Film resistor, 1%	0603	Yageo	RC0603FR-0724K9L
1	R3	41.2 $\Omega$	Film resistor, 1%	0603	Yageo	RC0603FR-0741R2L
1	R4	9.31k $\Omega$	Film resistor, 1%	0603	Yageo	RC0603FR-079K31L
1	R5	1k $\Omega$	Film resistor, 1%	0603	Yageo	RC0603FR-071KL
1	R6	150k $\Omega$	Film resistor, 1%	0603	Yageo	RC0603FR-07150KL
1	R7	5.1 $\Omega$	Film resistor, 1%	1206	Yageo	RC1206FR-075R1L
1	R8	0 $\Omega$	Film resistor, 1%	0603	Yageo	RC0603FR-070RL
1	D1	60V	Switching diode, 8A	Power DI5	Diodes, Inc.	SBR8U60P5
1	D2	58V	TVS diode, 4.3A, 400W	SMA	Littelfuse, Inc.	SMAJ58A
1	T1	55 $\mu$ H	Power transformer, N <sub>P</sub> :N <sub>S</sub> = 4.8:1	SMD	Sunlord	TWPEP090711B327T
	T1 (optional)	55 $\mu$ H	Power transformer, N <sub>P</sub> :N <sub>S</sub> = 4.8:1	SMD	Coilcraft	AC1584-AL
1	J1	2.54mm	Connector, angled socket header	DIP	Würth	613004143121
1	U1	MP8017	PoE device with an integrated PD interface	QFN-19 (3mmx 4mm)	MPS	MP8017GL

## EVB TEST RESULTS

Performance curves and waveforms are tested on the evaluation board,  $V_{IN} = 48V$ ,  $V_{OUT} = 5V$ ,  $f_{sw} = 500kHz$ ,  $T_A = 25^\circ C$ , unless otherwise noted.

Efficiency vs. Load Current

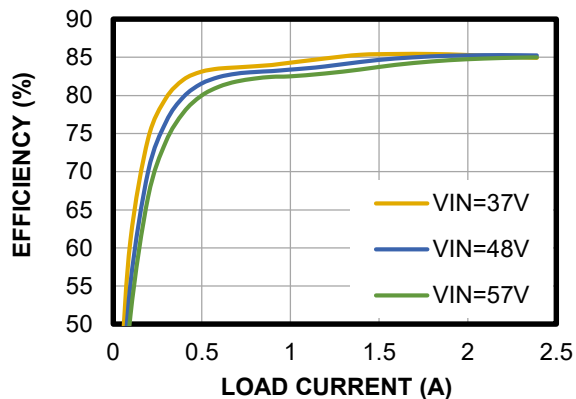

Load Regulation

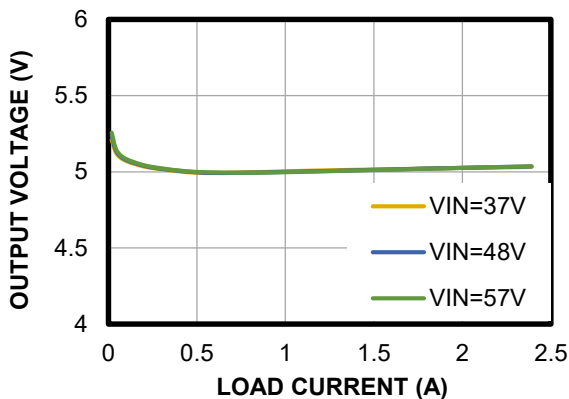

### Thermal Performance

$I_{OUT} = 2.4A$ , no forced airflow,  $T_{AMBIENT} = 28^\circ C$ ,  
 sp1 = MP8017, sp2 = transformer, sp3 = diode

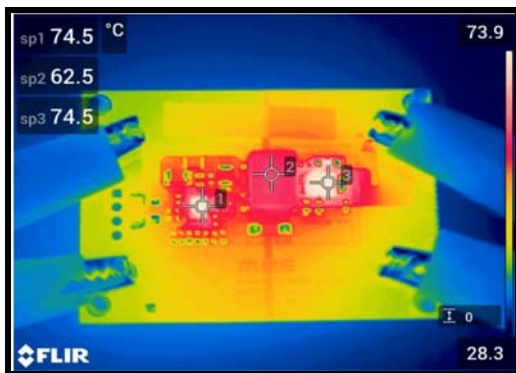

### EVB TEST RESULTS *(continued)*

Performance curves and waveforms are tested on the evaluation board,  $V_{IN} = 48V$ ,  $V_{OUT} = 5V$ ,  $f_{sw} = 500kHz$ ,  $T_A = 25^{\circ}C$ , unless otherwise noted.

#### Steady State and Output Ripple

$I_{OUT} = 2.4A$

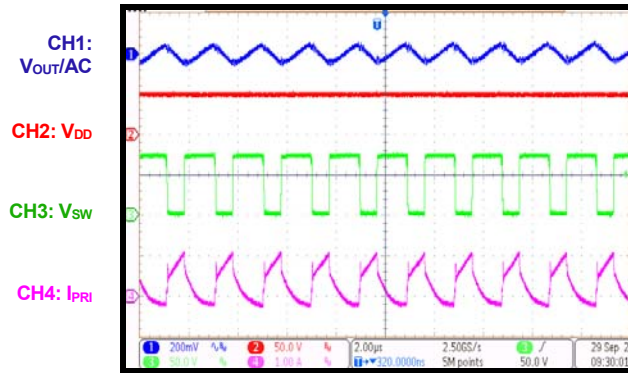

#### Load Transient Output Ripple

$I_{OUT} = 1.2A$  to  $2.4A$ , slew rate =  $25mA/\mu s$  (e-load)

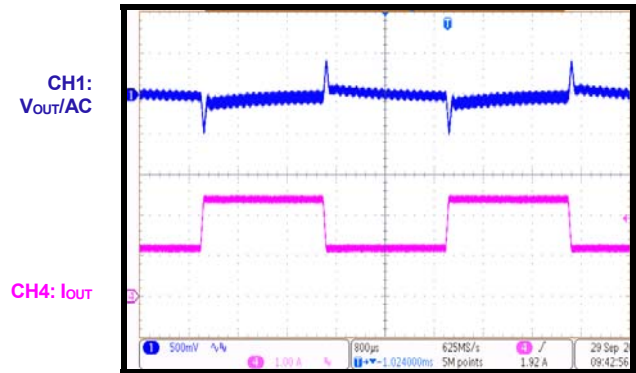

#### Radiated Emissions Results

$I_{OUT} = 2.4A$

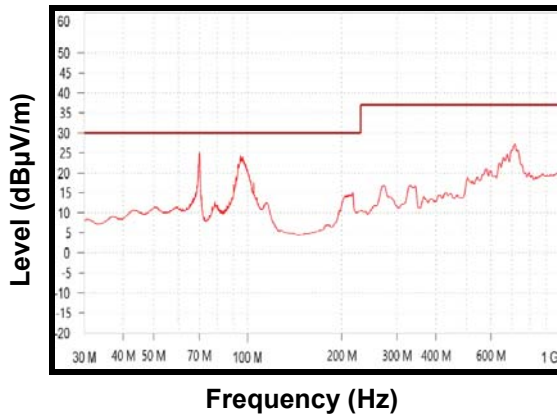

#### Conducted Emissions Results

$I_{OUT} = 2.4A$

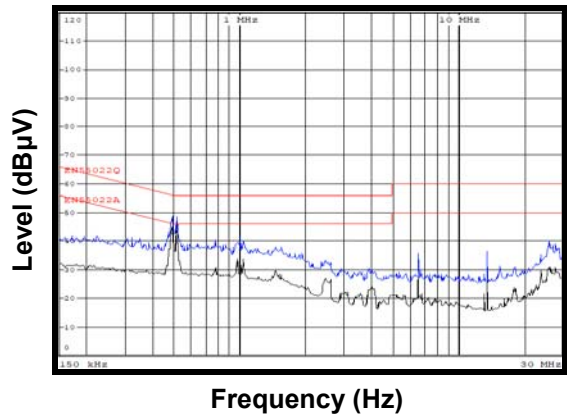

## PCB LAYOUT

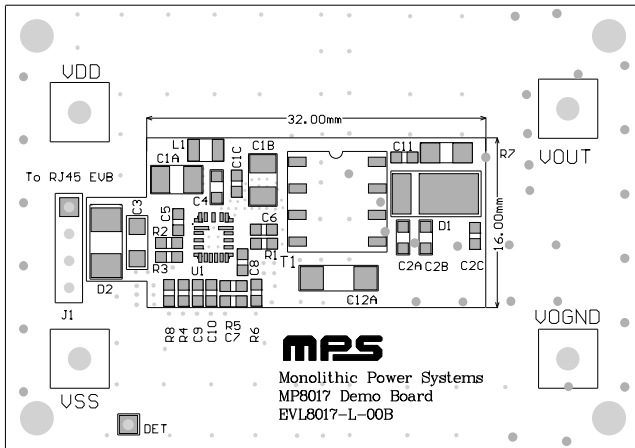

Figure 4: Top Silk

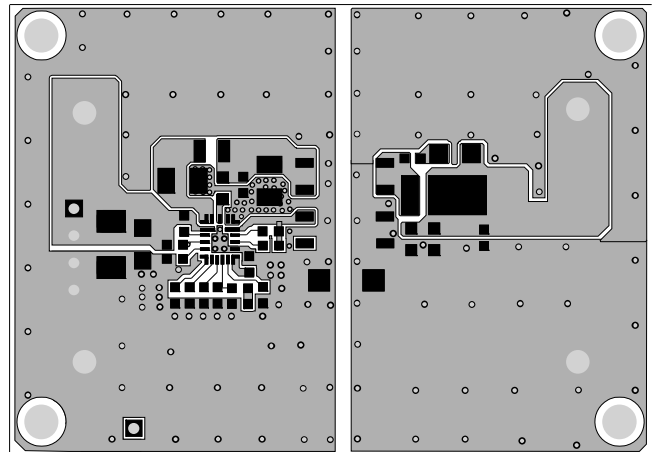

Figure 5: Top Layer

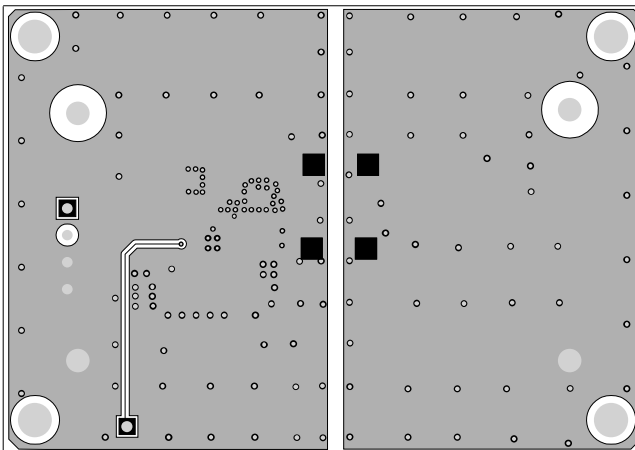

Figure 6: Bottom Layer

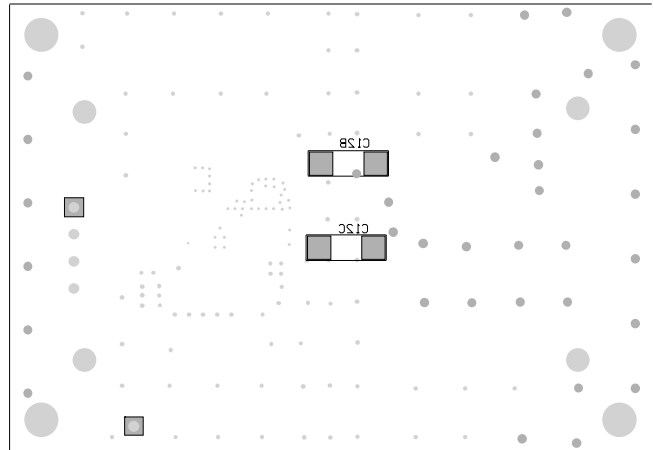

Figure 7: Bottom Silk



## REVISION HISTORY

Revision #	Revision Date	Description	Pages Updated
1.0	11/18/2021	Initial Release	-

**Notice:** The information in this document is subject to change without notice. Please contact MPS for current specifications. Users should warrant and guarantee that third-party Intellectual Property rights are not infringed upon when integrating MPS products into any application. MPS will not assume any legal responsibility for any said applications.