



EVL2328-TL-00A

High-Efficiency, 28V, 2A, 430kHz Synchronous Step-Down Converter In SOT583 Package

DESCRIPTION

The EVL2328 Evaluation Board is designed to demonstrate the capabilities of MPS' MP2328.

The MP2328 is a fully-integrated high-frequency, synchronous rectified, step-down, switch-mode converter with internal power MOSFETs. It offers a very compact solution to achieve a 2A continuous output current over a wide input range, with excellent load and line regulation. The MP2328 has synchronous-mode operation for high efficiency over wide output current-load range.

Constant On-Time control operation provides very fast transient response and easy loop design as well as very tight output regulation.

Full protection features include SCP, OCP, UVP and thermal shutdown.

The MP2328 requires a minimal number of readily-available, standard, external components and is available in a space-saving SOT583 package.

ELECTRICAL SPECIFICATION

Parameter	Symbol	Value	Units
Input Voltage	V _{IN}	6.5 - 28	V
Output Voltage	V _{OUT}	5	V
Output Current	I _{OUT}	0 - 2	A

FEATURES

- Wide 4.5V-to-28V Operating Input Range
- 115mΩ/55mΩ Low-R_{DS(ON)} Internal Power MOSFETs
- 160μA Quiescent Current
- >92% Efficiency for 24V to 5V/2A Condition
- Power Save Mode at Light Load
- Fast Load Transient Response
- 430kHz Switching Frequency
- Ton Extension for Improve Dropout
- Programmable Soft-Start Time
- Power Good Indication
- Hiccup Mode OCP/OVP Protection
- Thermal Shutdown Protection
- Includes an MPS-optimized Power Inductor

APPLICATIONS

- Game Consoles
- Digital Set-Top Boxes
- Flat-Panel Television and Monitors
- General Purposes Power Supply

All MPS parts are lead-free, halogen-free, and adhere to the RoHS directive. For MPS green status, please visit the MPS website under Quality Assurance. "MPS", the MPS logo, and "Simple, Easy Solutions" are registered trademarks of Monolithic Power Systems, Inc. or its subsidiaries.

EVL2328-TL-00A EVALUATION BOARD

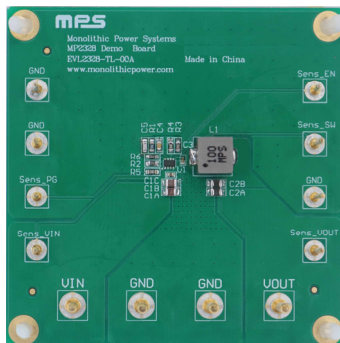

(L × W × H) 6.35cm x 6.35cm x 0.75cm

Board Number	MPS IC Number
EVL2328-TL-00A	MP2328GTL

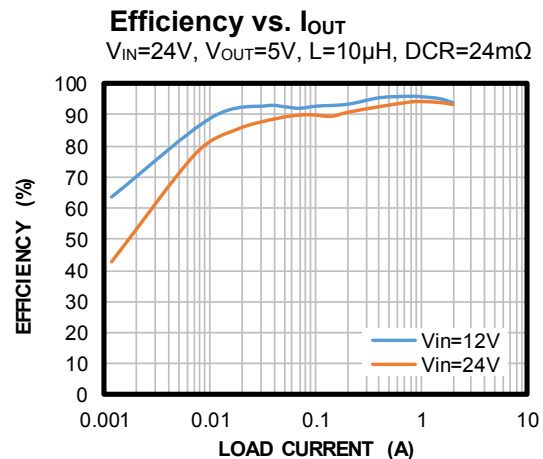

QUICK START GUIDE

The output voltage of this board is set to 5V. The board layout accommodates most commonly used components. Following are steps to quick start EVL2328-TL-00A.

1. Preset Power Supply to $6.5V \leq V_{IN} \leq 28V$.
2. Turn Power Supply off.
3. Connect Power Supply terminals to:
 - a. Positive (+): VIN
 - b. Negative (-): GND
4. Connect Load to:
 - a. Positive (+): VOUT
 - b. Negative (-): GND
5. Turn Power Supply on after making connections.
6. The MP2328 is enabled on the evaluation board once VIN is applied.
7. The output voltage VOUT can be changed by varying R1 and R2. Calculate the new value using the formula:

$$V_{OUT} = V_{FB} \times \left(1 + \frac{R1}{R2}\right)$$

Where $V_{FB} = 0.5V$.

8. To use the Enable function, apply a digital input to the EN pin. Drive EN higher than 1.3V to turn on EVL2328-TL-00A or less than 1V to turn it off. The EN voltage must not exceed 6V max to avoid damaging the internal circuit.

EVALUATION BOARD SCHEMATIC

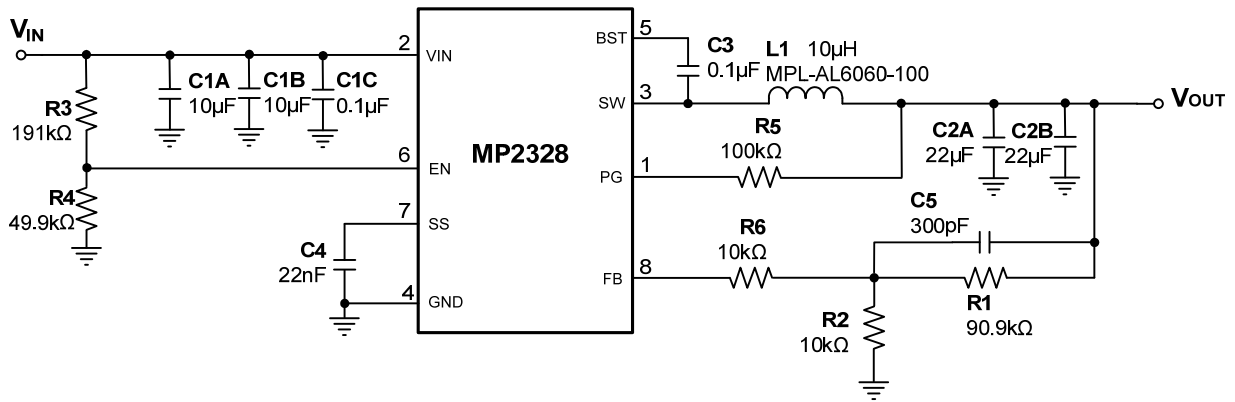

EVL2328-TL-00A BILL OF MATERIALS

Qty	Ref	Value	Description	Package	Manufacturer	Manufacturer PN
1	L1	10 μ H	Inductor, RDC=24m Ω , Isat=6.6A	SMD	MPS	MPL-AL6060-100
2	C1A,C1B	10 μ F	Ceramic Cap, 50V, X5R	0805	Murata	GRM21BR61H106KE43L
2	C1C,C3	100nF	Ceramic Cap, 50V, X7R	0402	Murata	GRM155R71H104ME14D
2	C2A,C2B	22 μ F	Ceramic Cap, 10V, X7S	0805	TDK	C2012X7S1A226MT000E
1	C4	22nF	Ceramic Cap, 25V, X7R	0603	Murata	GRM188R71E223JA01D
1	C5	300pF	Ceramic Cap, 50V, COG	0603	Murata	GRM1885C1H301JA01D
1	R1	90.9K	Film Res, 1%	0603	YAGEO	RC0603FR-0790K9L
1	R2	10K	Film Res, 1%	0603	YAGEO	RC0603FR-0710KL
1	R3	191K	Film Res, 1%	0603	YAGEO	RC0603FR-07191KL
1	R4	49K9	Film Res, 1%	0603	YAGEO	RC0603FR-0749K9L
1	R5	100K	Film Res, 1%	0603	YAGEO	RC0603FR-07100KL
1	R6	10K	Film Res, 1%	0603	YAGEO	RC0603FR-0710KL
1	U1	MP2328	28V/2A Buck	SOT583	MPS	MP2328GTL

EVB TEST RESULTS

Performance curves and waveforms are tested on the evaluation board.

$V_{IN} = 24V$, $V_{OUT} = 5V$, $L = 10\mu H$, $T_A = 25^\circ C$, unless otherwise noted.

Efficiency vs. I_{OUT}

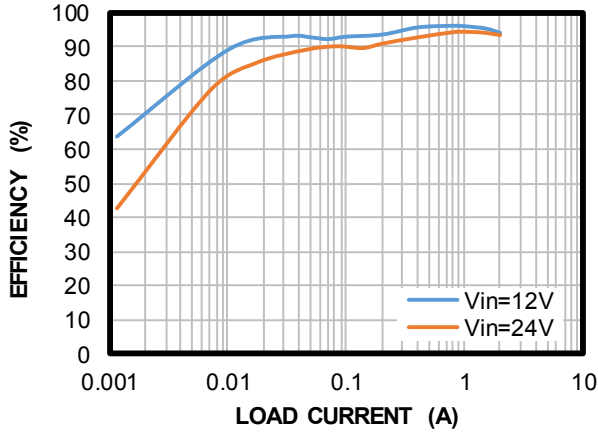

Load Regulation

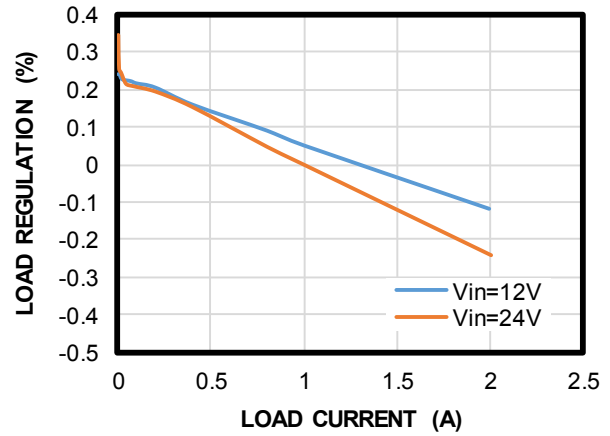

Line Regulation

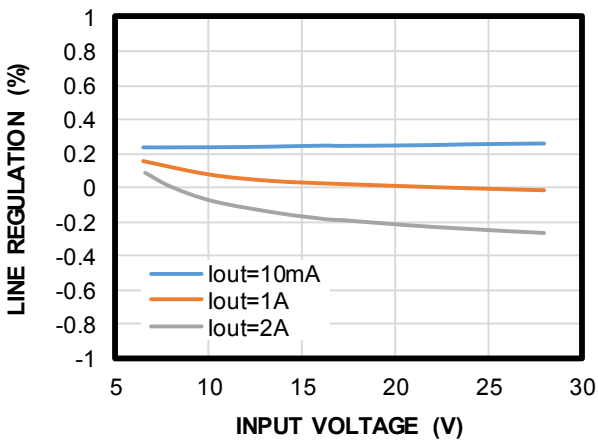

Case Temperature Rise vs. I_{OUT}

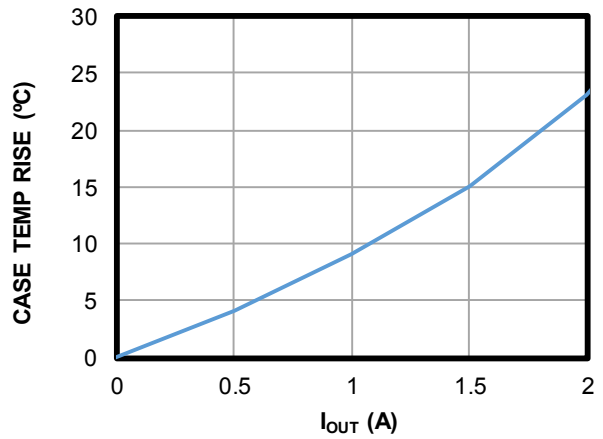

EVB TEST RESULTS (continued)

Performance curves and waveforms are tested on the evaluation board.

$V_{IN} = 24V$, $V_{OUT} = 5V$, $L = 10\mu H$, $T_A = 25^\circ C$, unless otherwise noted.

Steady State

$I_{OUT}=0A$

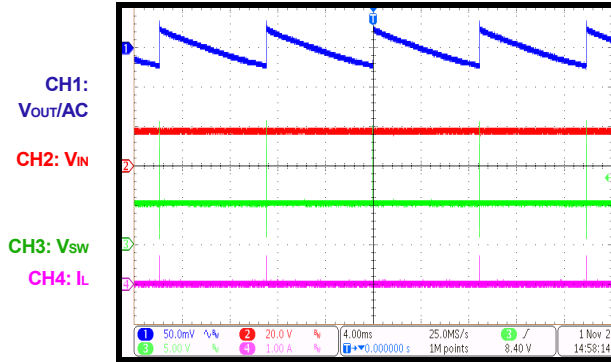

Steady State

$I_{OUT}=1A$

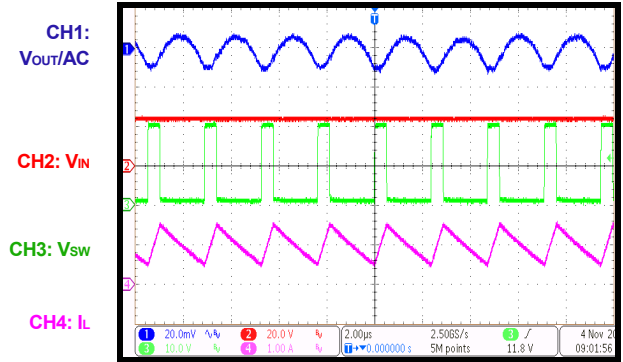

Steady State

$I_{OUT}=2A$

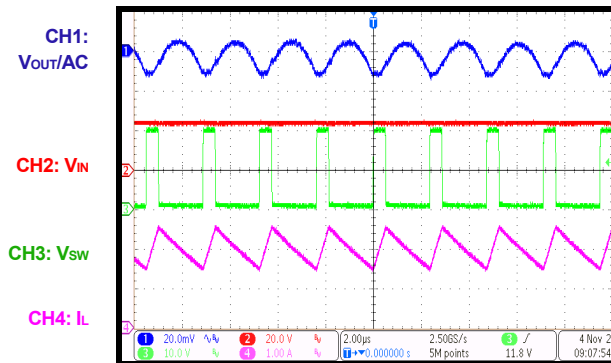

Input Power Start-Up

$I_{OUT}=0A$

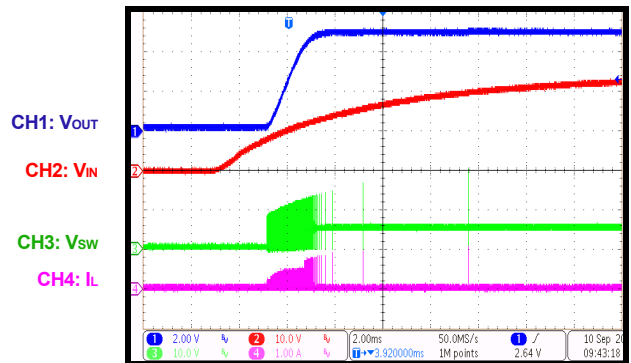

Input Power Start-Up

$I_{OUT}=2A$

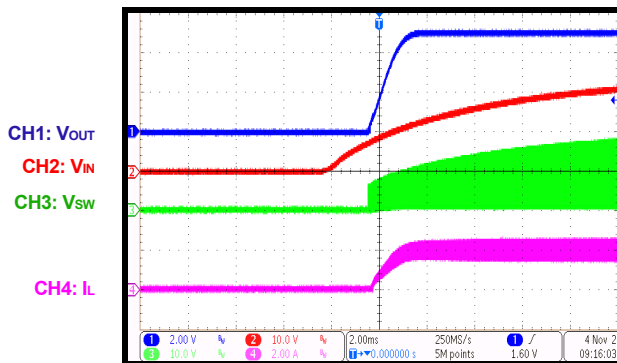

Input Power Shutdown

$I_{OUT}=0A$

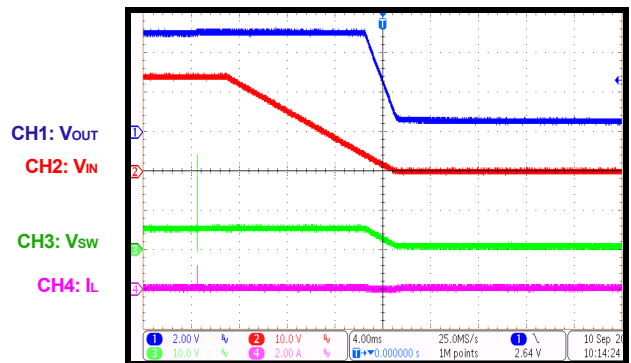

EVB TEST RESULTS (continued)

Performance curves and waveforms are tested on the evaluation board.

$V_{IN} = 24V$, $V_{OUT} = 5V$, $L = 10\mu H$, $T_A = 25^\circ C$, unless otherwise noted.

Input Power Shutdown

$I_{OUT}=2A$

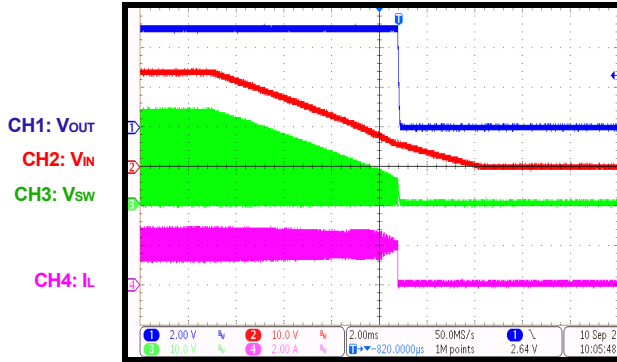

Start-Up through Enable

$I_{OUT}=0A$

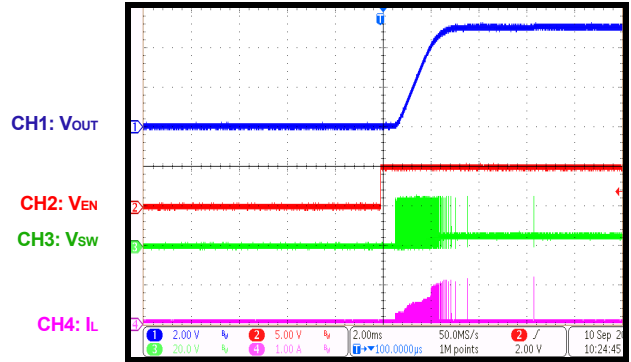

Start-Up through Enable

$I_{OUT}=2A$

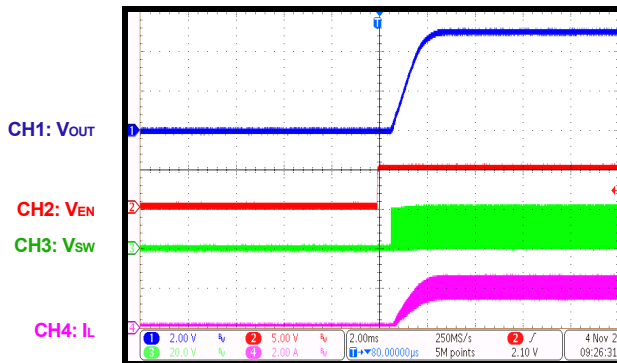

Shutdown through Enable

$I_{OUT}=0A$

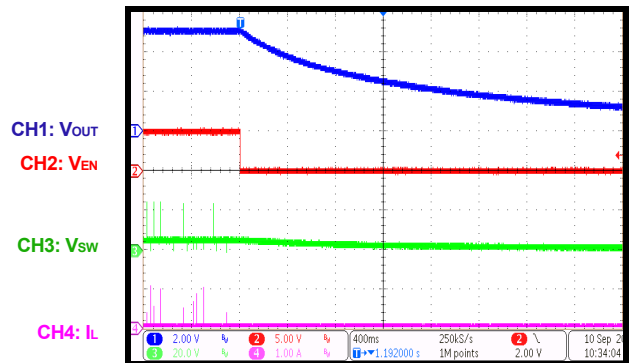

Shutdown through Enable

$I_{OUT}=2A$

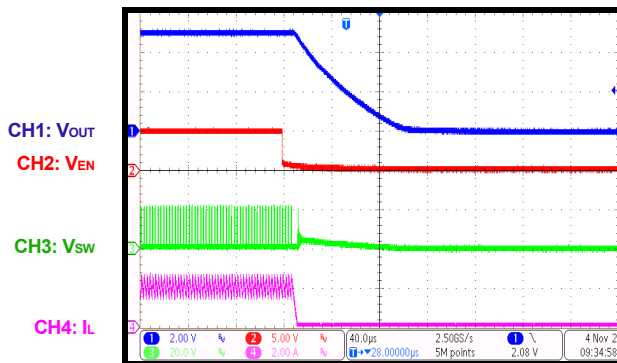

Load Transient

$I_{OUT}=0-1A$

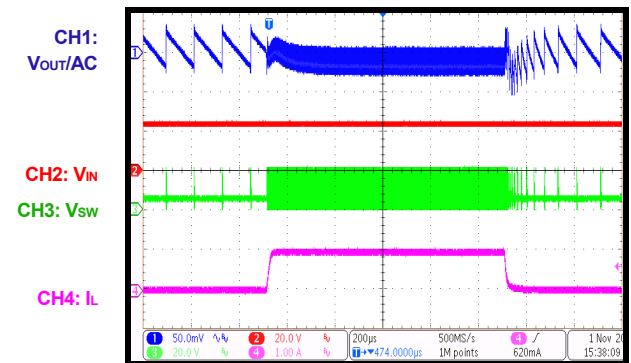

EVB TEST RESULTS (continued)

Performance curves and waveforms are tested on the evaluation board.

$V_{IN} = 24V$, $V_{OUT} = 5V$, $L = 10\mu H$, $T_A = 25^\circ C$, unless otherwise noted.

Load Transient

$I_{OUT} = 1-2A$

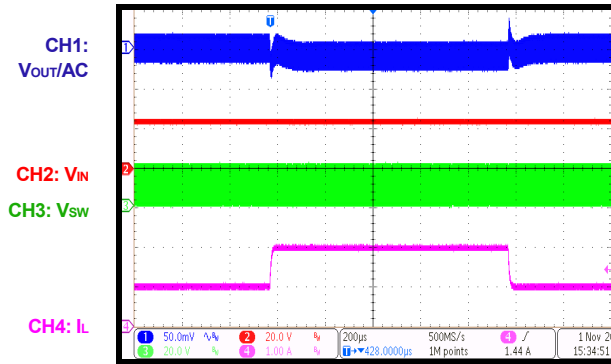

SCP

$I_{OUT} = 0A$, Entry

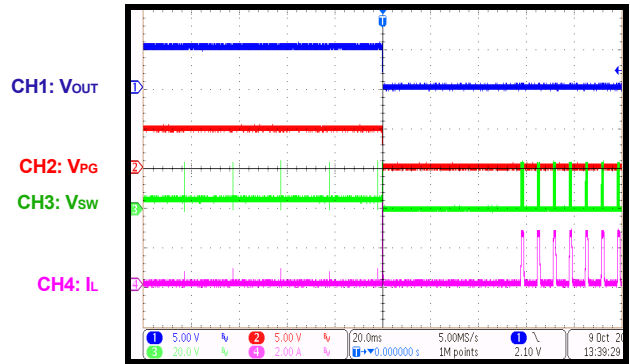

SCP

Steady State

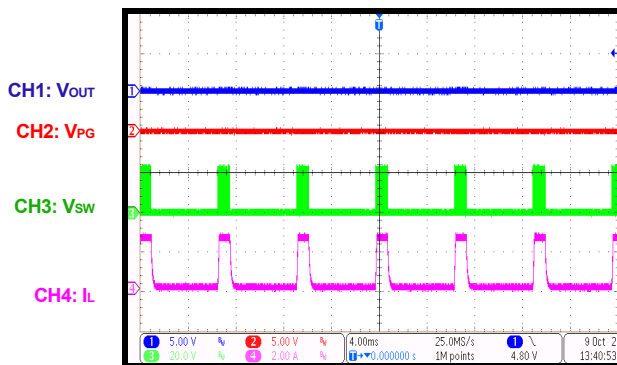

SCP

$I_{OUT} = 0A$, Recovery

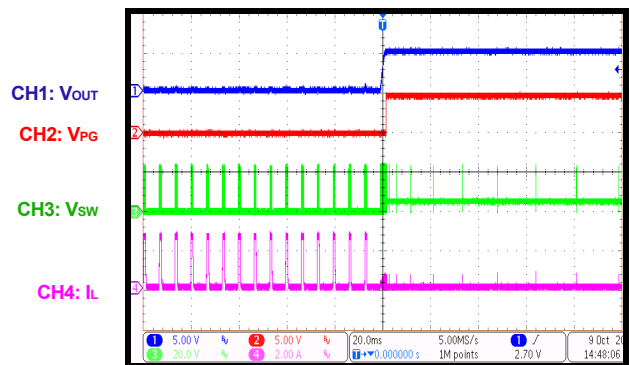

PRINTED CIRCUIT BOARD LAYOUT

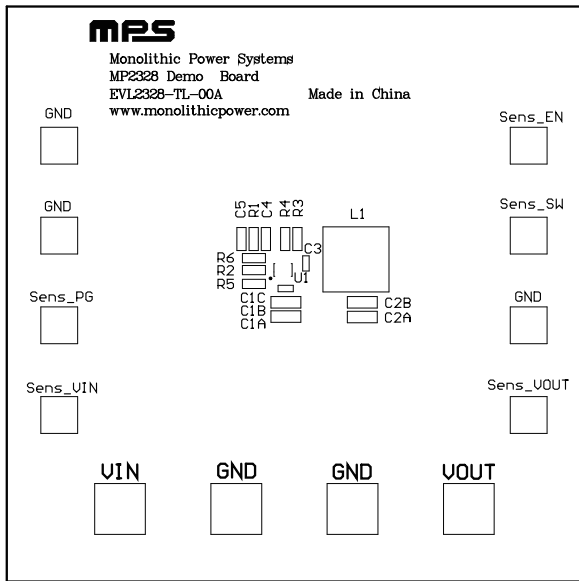

Figure 1: Top Silkscreen Layer

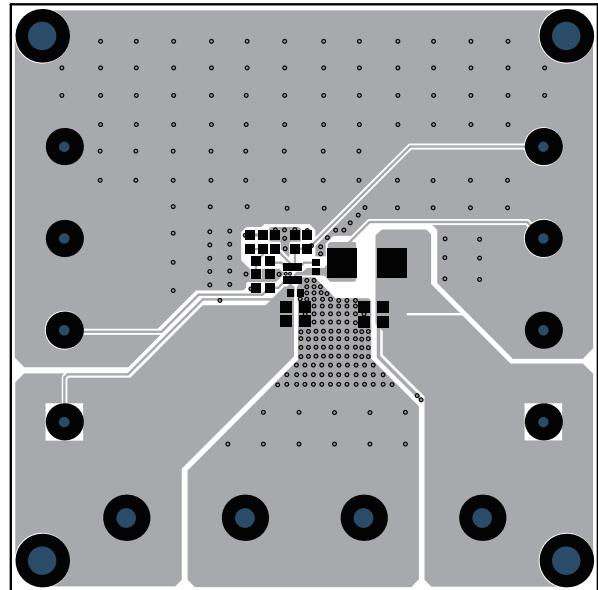

Figure 2: Top Layer

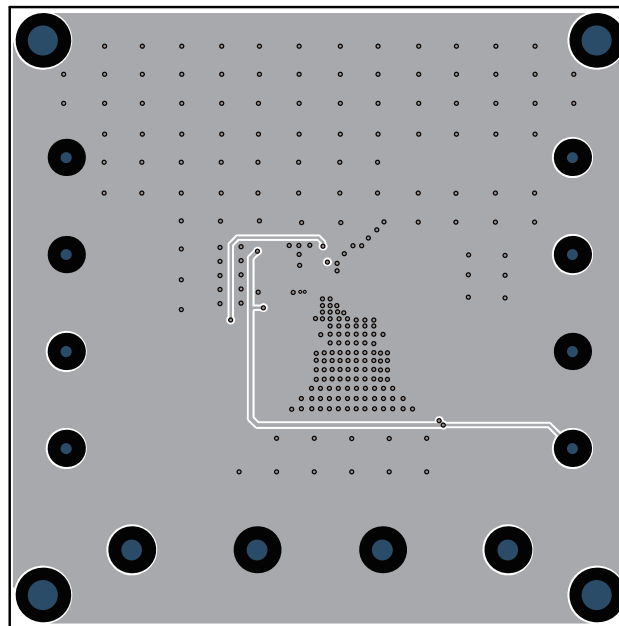

Figure 3: Bottom Layer

NOTICE: The information in this document is subject to change without notice. Please contact MPS for current specifications. Users should warrant and guarantee that third party Intellectual Property rights are not infringed upon when integrating MPS products into any application. MPS will not assume any legal responsibility for any said applications.