



MPS[®]

User Guide

MP2722 Evaluation Kit (EVKT-MP2722)

Table of Contents

Overview	3
Introduction	3
Kit Contents	3
Features and Benefits	4
Kit Specifications	4
Section 1. Hardware Specifications	6
1.1 Personal Computer Requirements	6
1.2 EV2722-RH-00A Specifications	6
1.3 EVKT-USBI2C-02 Specifications	6
Section 2. Software Requirements	7
2.1 Software Installation Procedure	7
Section 3. Evaluation Kit Test Set-Up	8
3.1 Hardware Set-Up	8
3.2 Powering Up the EVB.....	8
3.3 Software Set-Up	8
3.4 Device Programming Instructions	10
3.5 Troubleshooting Tips.....	13
Section 4. Ordering Information	14

Overview

Introduction

The EVKT-MP2722 is an evaluation kit for the MP2722. It is used to demonstrate the capabilities of the MP2722, an I²C-controlled, single-cell, 5A, narrow-voltage DC (NVDC) buck charger with USB Type-C dual-role power (DRP) detection. The device can accept a 4V to 16V input voltage (V_{IN}) to charge the battery. The default function of this board is preset for charger mode, and the charge-full voltage is preset to 4.2V for a single-cell Li-ion battery.

Kit Contents

EVKT-MP2722 kit contents (items below can be ordered separately):

#	Part Number	Item	Quantity
1	EV2722-RH-00A	MP2722 evaluation board	1
2	EVKT-USBI2C-02	Includes one USB-to-I ² C communication interface, one USB cable, one ribbon cable	1
3	Online resources	Include GUI and supplemental documents	-

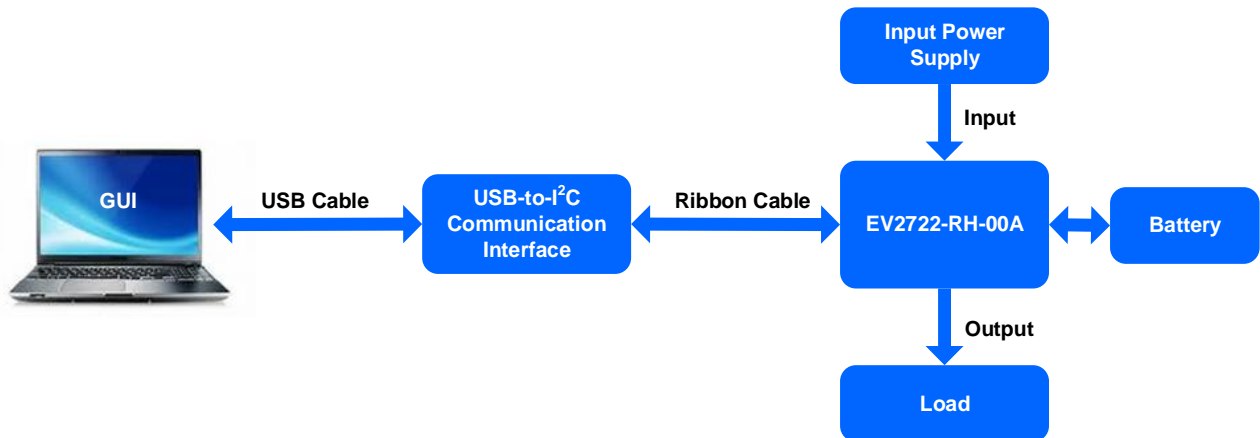

Figure 1: EVKT-MP2722 Evaluation Kit Set-Up

Features and Benefits

- Fully Integrated CC Controller Compliant with USB Type-C 1.3
- USB-C Dual-Role Power (DRP) with Try.SNK and Try.SRC Mode Support
- Supports USB BC 1.2 and Non-Standard Adapters
- 26V Sustainable Input Voltage (V_{IN})
- Configurable 80mA to 5A Charge Current (I_{CC}) via the I²C
- Configurable 100mA to 3.2A Input Current Limit (I_{IN_LIM}) via the I²C
- Minimum V_{IN} Loop for Maximum Adapter Power Tracking
- Comprehensive Safety Features:
 - Fully Customizable JEITA Profile
 - Additional Negative Temperature Coefficient (NTC) Thermistor Input
 - Configurable Die Temperature Regulation from 60°C to 120°C
 - Complete Charge and Pre-Charge Safety Timers
 - Watchdog Safety Timer
- Configurable 750kHz to 1.5MHz Switching Frequency (f_{SW})
- Ultra-Low 8.5µA Battery Discharge Current in Shipping Mode
- Down to 30mA Termination Current Settings for Wearable Applications
- I²C Port for Flexible System Parameter Setting and Status Reporting
- Configurable Boost Converter for Source Mode and USB On-The-Go (OTG)
- Accuracy:
 - ±0.5% Battery Regulation Voltage (V_{BATT_REG})
 - ±5% I_{CC}
 - ±5% I_{IN_LIM}
 - ±2% Output Regulation in Boost Mode
- Available in a Small QFN-22 (2.5mmx3.5mm) Package

⚠ *All changes made in I²C mode are not retained once the evaluation board shuts down.*

⚠ *Information written in OTP mode cannot be changed.*

Adjustable Features

I ² C	OTP
<ul style="list-style-type: none"> • Charge Current (I_{TC}, I_{PRE}, I_{CC}, I_{TERM}) • Battery-Full Voltage • V_{IN_LIM} Regulation Voltage • I_{IN_LIM} Regulation Current • V_{SYS_MIN} Regulation Voltage • Safety Charge Timer • Over-Voltage Protection (OVP) Thresholds • NTC Thresholds • Thermal Regulation Point • CC1/CC2 Configuration Options • Switching Frequency (f_{SW}) • Output Voltage in Source Mode • Output Current Limit in Source Mode 	<ul style="list-style-type: none"> • EN_STAT_IB Default Value • EN_PG_NTC2 Default Value • Hold-Off Timer Default Value • Default f_{SW} • IIN_MODE Default Value • Default Charge Current (I_{TC}, I_{PRE}, I_{CC}, I_{TERM}) • Default Battery-Full Voltage • Default V_{IN_OVP} Threshold • V_{SYS_MIN} Default Value • Watchdog Timer Default Value • Default Boost Output Voltage • CC1/CC2 Default Configurations (CC_CFG, RP_CFG, FORCE_CC) • AUTOOTG, AUTODPDM Default Value • HVEN Default Value • NTC1_ACTION Default Value • NTC2_ACTION Default Value • BOOST_STP_EN Default Value • BOOST_OTP_EN Default Value • Interrupt Mask Default Value

Kit Specifications

Features	Specifications
Supply for Board	4V to 16V
Operating Input Voltage	4V to 16V
Operating Systems Supported	Windows XP, 7, or later
System Requirements	Minimum 21.6MB free
GUI Software	Programming tool MP2722
EVb Size (LxW)	6.3cmx6.3cm

Section 1. Hardware Specifications

1.1 Personal Computer Requirements

The following minimum requirements must be met to use the EVKT-MP2722:

- Operating System of Windows XP, 7, or later
- Net Framework 4.0
- PC with a minimum of one available USB port
- At least 21.6MB of free space

1.2 EV2722-RH-00A Specifications

The EV2722-RH-00A is an evaluation board for the MP2722. For more information, refer to the EV2722-RH-00A datasheet.



Figure 2: EV2722-RH-00A Evaluation Board

Feature	Specifications
Supply for Evaluation Board	4V to 16V
Operating Input Voltage	4V to 16V
EVB Size (LxW)	6.3cmx6.3cm

1.3 EVKT-USBI2C-02 Specifications

The EVKT-USBI2C-02 refers to the USB-to-I²C communication interface, which connects the EVB, the PC, and its supporting accessories (see Figure 3). It provides I²C capabilities. Together with MPS Virtual Bench Pro and I²C GUI tools, it provides a quick and easy way to evaluate the performance of MPS digital products. For more details, refer to the EVKT-USBI2C-02 datasheet.



Figure 3: EVKT-USBI2C-02 Communication Interface

Section 2. Software Requirements

2.1 Software Installation Procedure

Programming occurs through the MPS I²C GUI. Follow the instructions below to install the software:

Note: This software can be downloaded from the MPS website.

1. Download and extract the relevant files from the MPS website.
2. Double click the “.exe” file to open the set-up guide (see Figure 4). If a protection window comes up, click “More info,” then click “Run anyway.”
3. Follow the prompts in the set-up guide.
4. Wait for the status screen to verify that installation is complete (see Figure 5).

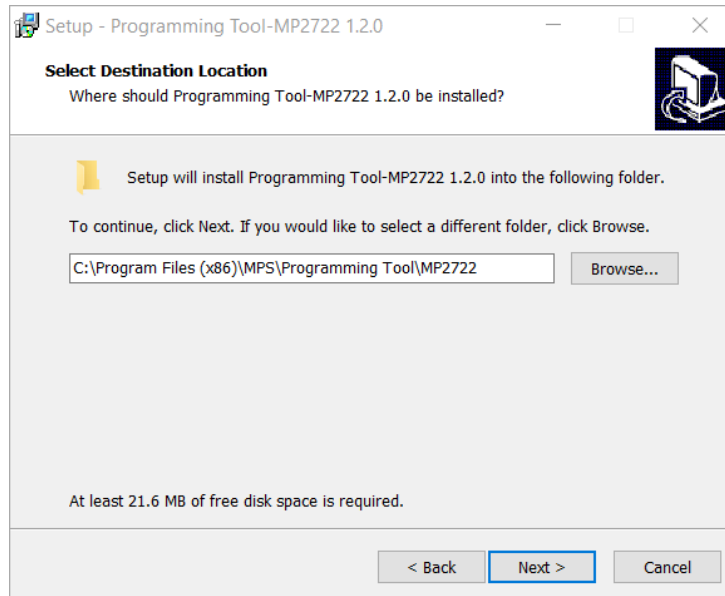

Figure 4: MPS I²C GUI Set-Up Guide



Figure 5: Driver Set-Up Success

Section 3. Evaluation Kit Test Set-Up

3.1 Hardware Set-Up ⁽¹⁾

The hardware must be properly configured prior to use. Follow the instructions below to set up the EVB:

1. Connect the EVB to the EVKT-USBI2C-02 communication interface with the 3-pin ribbon cable or 10-pin ribbon cable, and ensure that they are connected.
2. Connect SCL, SDA, and GND (see Figure 6). Refer to the MP2722 datasheet for additional clarification.
3. Connect the EVKT-USBI2C-02 to the computer.

Note:

- 1) It is important to adhere to the order of these steps. Failing to do so may cause damage to the communication pins (SCL and SDA) during a hot-plug event.

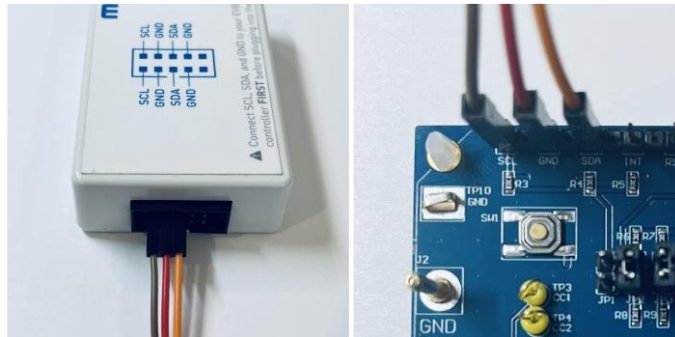

Figure 6: EVB to MPS I²C Communication Interface Wire Connection

3.2 Powering Up the EVB

1. Connect the load terminals to:
 - a. Positive (+): SYS
 - b. Negative (-): GND
2. Connect the battery terminals to:
 - a. Positive (+): BATT
 - b. Negative (-): GND
3. If using a battery simulator, preset the battery voltage to be between 0V and 4.2V, then turn it off. Connect the battery simulator output to the BATT and GND pins, respectively.
4. Preset the power supply output to be between 4V and 16V, and then turn off the power supply.
5. Connect the power supply terminals to:
 - a. Positive (+): VIN
 - b. Negative (-): PGND
6. Ensure the battery voltage is present (if using a battery simulator, turn on the battery simulator). Turn the power supply on. The IC should start up automatically.

3.3 Software Set-Up

After connecting the hardware according to the steps above, follow the steps below to use the GUI software:

1. Start the software. It should automatically check the EVB connection.

- If the connection is successful, “Device connected” will be shown at the bottom left of the screen (see Figure 7).



Figure 7: Connected Status Shows Successful Connection

- If the connection is unsuccessful, a warning should appear at the bottom. There are two potential warnings.
 - If the application shows “Device disconnected”, this means that the evaluation board is not connected correctly (see Figure 8).
 - If the application shows “USB disconnected”, this means that the USB-to-I²C communication interface is not connected correctly (see Figure 9 on page 10).

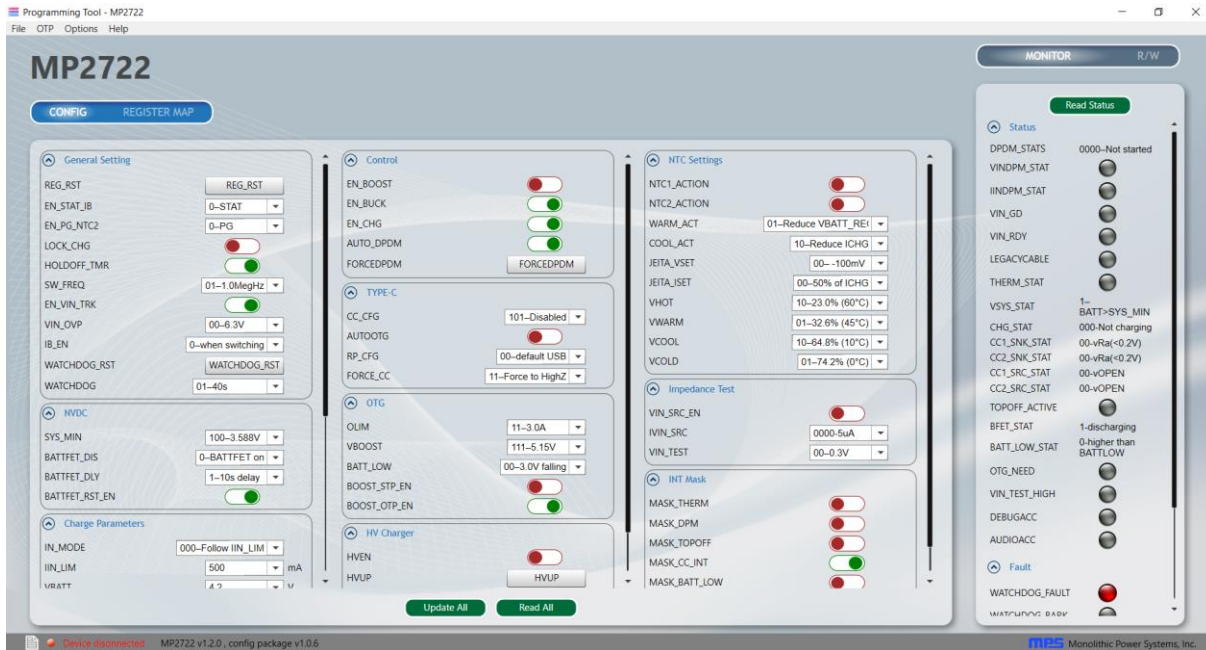

Figure 8: Warning Indicates Unsuccessful Connection (Evaluation Board is Not Connected)

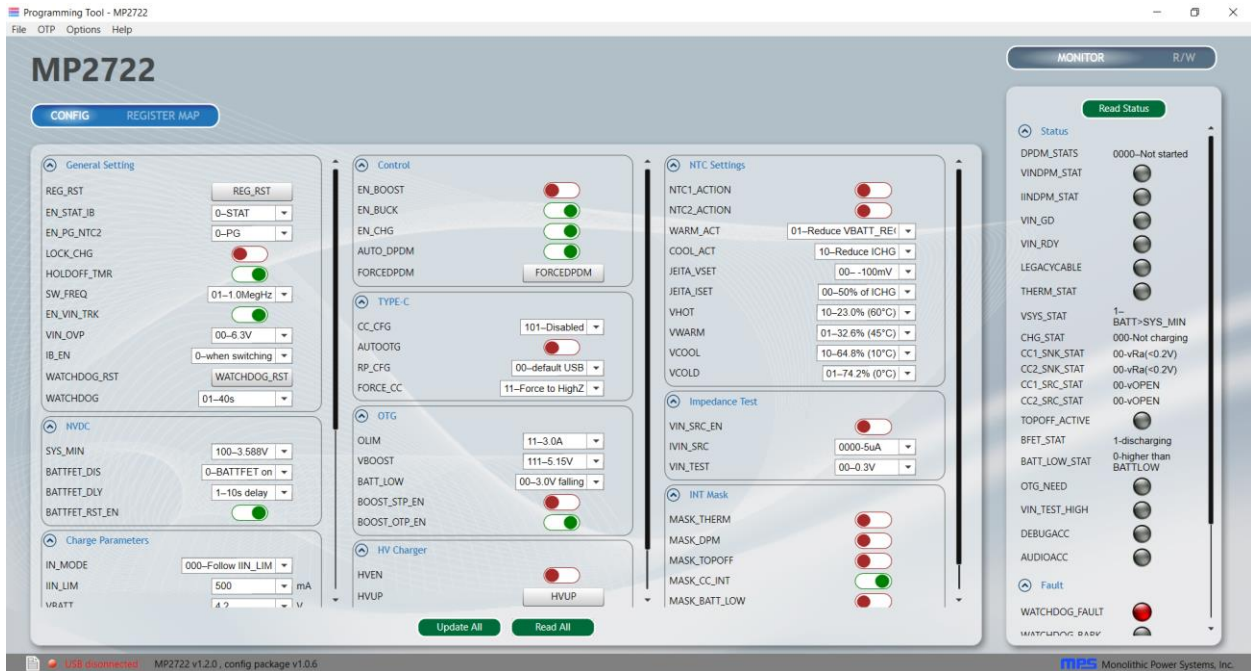

Figure 9: Warning Indicates Unsuccessful Connection (USB I²C Communication Interface is Not Connected)

2. If the connection is successful, proceed to Step 3. Otherwise, check connections between the EVB, communication interface, and PC. Re-plug the USB into the computer and restart the GUI.
3. Click the “Read All” button to read the I²C register values. The default values should be displayed (see Figure 7 on page 9).
4. Find the item(s) to be changed, then select the target value(s) from the drop-down menu.
5. Click the “Write All” button to update the values. The changed information should be downloaded to the IC.

⚠ All changes made via the PC are restored to their default values once the EVB is powered down.

3.4 Device Programming Instructions

The MP2721-xxxx is a one-time programmable (OTP) memory part, where “xxxx” is the register setting option. The factory default is “0000,” and this content can be viewed in the I²C register map. Follow the instructions below to create and export customized configurations:

1. Using a computer, open the MPS GUI software. Ensure that the EVB has powered on.
2. Ensure that there is a successful connection between the EVB and computer.
3. Select “OTP View” in the toolbar (see Figure 10).

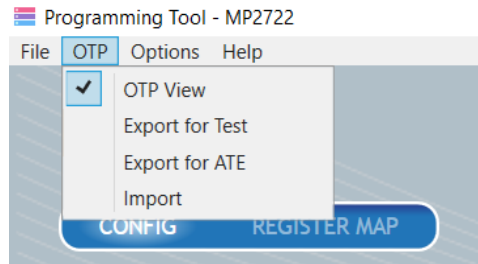

Figure 10: Select OTP View, Located in Toolbar

4. All selectable parameters can be changed (see Figure 11).



Figure 11: Parameters that can be Adjusted in OTP Mode

5. Select the target value(s) from the drop-down menu(s).
6. Ensure that all the parameters have been input, then click “Export for Test” in the toolbar (see Figure 12).

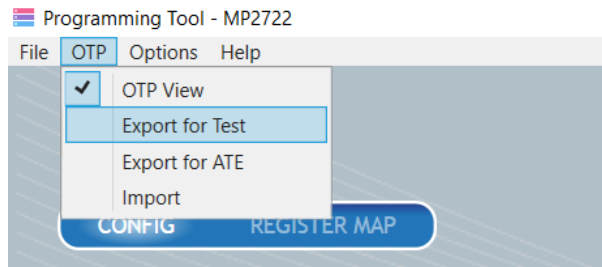

Figure 12: Click Export for Test

7. Export the selected configurations by clicking “Export” (see Figure 13).

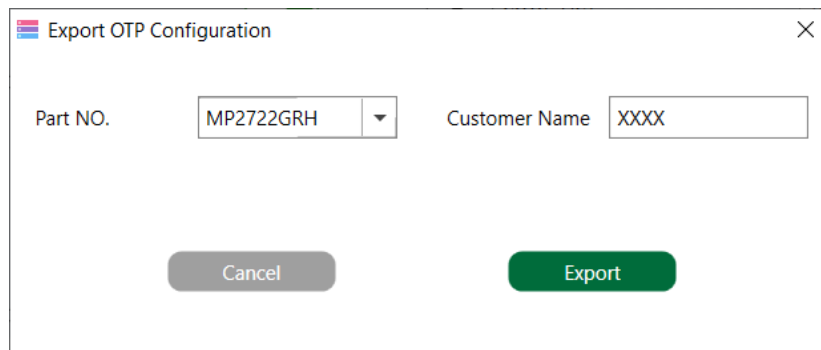

Figure 13: Click Export Buttons

8. Find a location for the exported file and click “Save”. The configurations should be saved in a text file (see Figure 14).

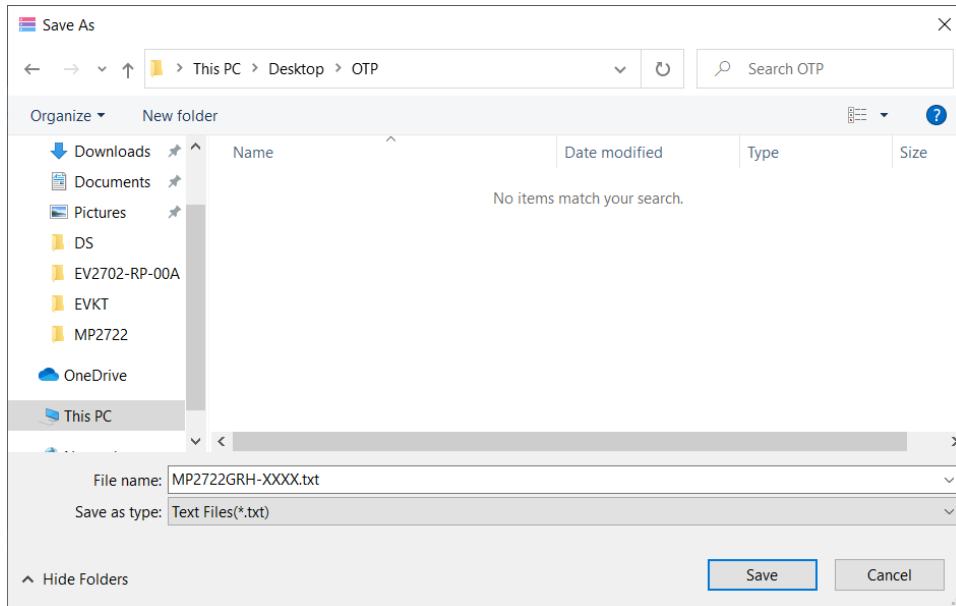

Figure 14: Export Text File

9. Send this file to an MPS FAE to apply for the customized “xxxx” code

3.5 Troubleshooting Tips

EVKT-USBI2C-02 Driver Installation Problem

If the USBI2C-02 driver is not properly installed, manual installation is required. Follow the steps below to manually install the EVKT-USBI2C-02 driver:

Note: Find “USBXpress Device” in the Device Manager.



If the PC is running Windows 10, check the driver version of USBXpress Device. Windows 10 will automatically install the older USB driver, which is not compatible. The correct driver version should be newer than 4.0.0.0 (see Figure 15).

1. Install the correct USBXpress “.exe” file. Choose either the 32-bit or 64-bit operating system.

32-bit: USBXpressInstaller_x86.exe

64-bit: USBXpressInstaller_x64.exe

2. Connect the EVKT-USBI2C-02 communication interface to the PC with a USB cable.

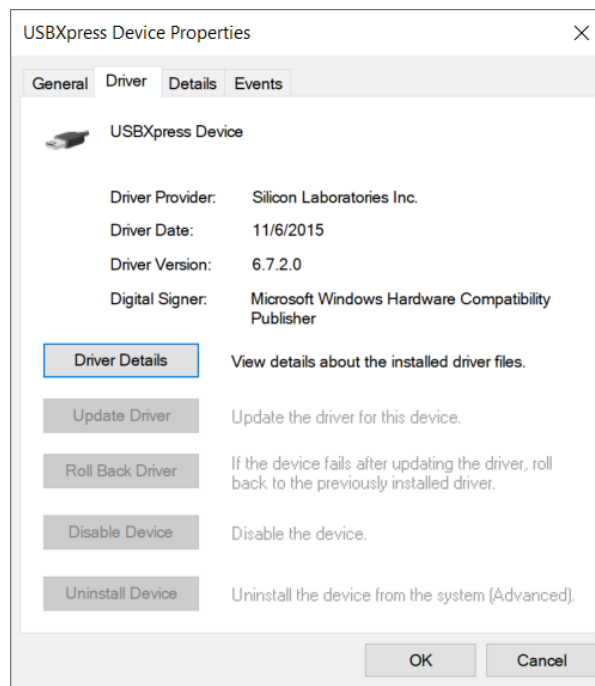

Figure 15: Correct Driver Version

No Supply

The IC’s input pin has an under-voltage lockout (UVLO) detection circuit. If the input voltage (V_{IN}) is falls below the UVLO rising threshold, the charging function is disabled.

Shutdown Event

If the IC detects that V_{IN} is below the UVLO falling threshold (device enters a no supply state), or over-temperature protection is triggered (device enters a shutdown state), the IC stops switching and charging is suspended.

Thermal Recovery

If the die temperature exceeds the thermal protection threshold, the device enters a shutdown state. The IC starts up again once the die temperature decreases.

Section 4. Ordering Information

The components of the evaluation kit can be purchased separately depending on user needs.

Part Number	Description
EVKT-MP2722	Complete evaluation kit
Contents of EVKT-MP2722	
EV2722-RH-00A	MP2722 evaluation board
EVKT-USBI2C-02	Includes one USB-to-I ² C communication interface, one USB cable, and one ribbon cable
Online resources	Include GUI and supplemental documents

Order directly from MonolithicPower.com or our distributors.

REVISION HISTORY

Revision #	Revision Date	Description	Pages Updated
1.0	2/17/2023	Initial Release	-

Notice: The information in this document is subject to change without notice. Please contact MPS for current specifications. Users should warrant and guarantee that third-party Intellectual Property rights are not infringed upon when integrating MPS products into any application. MPS will not assume any legal responsibility for any said applications.