



The Future of Analog IC Technology®

# EVHR2000-S-00A Fluorescent Lamp HB Driver with PFC

## DESCRIPTION

The EVHR2000-S-00A is an evaluation board for the HR2000. The HR2000 is a fluorescent lamp ballast controller with PFC function and high voltage half-bridge driver. Only 16pin is used to offer cost effective solutions with minimized external components.

The EVHR2000DS-00A is designed to drive 16W fluorescent lamp. With the simple and sufficient on-time control APFC, the demo board provides 400V DC bus voltage for ballast and clean load for Grid. The power factor is greater than 0.9 in all input voltage range. The over-voltage and over-current protection of PFC stage are integrated to ensure the safety.

The half-bridge ballast controller directly drives two MOSFETs to control the fluorescent lamp. The preheat and ignition time are programmed to proper level to meets the characteristics of fluorescent lamp. The over-voltage, over-current, capacitive-mode, and end-of-life (EOL) protection are all integrated.

The EVHR2000DS-00A meets EN55015 EMI standard. And THD meets IEC61000-3-2 Class C standard.

## ELECTRICAL SPECIFICATION

Parameter	Symbol	Value	Units
Input Voltage	V <sub>in</sub>	198-264	VAC
AC Line Frequency	f <sub>LINE</sub>	50	Hz
Lamp Voltage	V <sub>lamp</sub>	55	Vrms
Lamp Current	I <sub>lamp</sub>	0.29	A
Lamp Power	P <sub>lamp</sub>	16	W
Preheat Current	I <sub>pre</sub>	0.18-0.3	A
Preheat time	t <sub>Pre</sub>	674	ms
Open circuit voltage	V <sub>oc</sub>	300	Vrms
Burning frequency	f <sub>run</sub>	40-50	kHz
Efficiency	η	>80	%
Power Factor	PF	>90	%

## Features

### PFC PART

- Only four pins realize PFC function.
- Ton control.
- Boundary Conduction Mode operation.
- Less peripheral components.
- Over voltage and over current protection.

### HALF-BRIDGE PART

- 600V bootstrap half-bridge driver.
- Programmable preheat current.
- Programmable preheat time.
- Programmable ignition time.
- Single ignition attempt.
- Over voltage protection.
- Over current protection.
- End-Of-Life protection
- Capacitive mode protection.
- Minimized external components.
- Over temperature protection

## APPLICATIONS

- Tube fluorescent lamp ballast
- Compact fluorescent lamp ballast

All MPS parts are lead-free and adhere to the RoHS directive. For MPS green status, please visit MPS website under Quality Assurance.

"MPS" and "The Future of Analog IC Technology", are Registered Trademarks of Monolithic Power Systems, Inc.



**Warning:** Although this board is designed to satisfy safety requirements, the engineering prototype has not been agency approved. Therefore, all testing should be performed using an isolation transformer to provide the AC input to the prototype board.

### EVHR2000-S-00A EVALUATION BOARD



**FRONT**



**BACK**

(L x W x H) 26cm x 2.7cm x 2.4cm

Board Number	MPS IC Number
EVHR2000-S-00A	HR2000DS

# EVALUATION BOARD SCHEMATIC

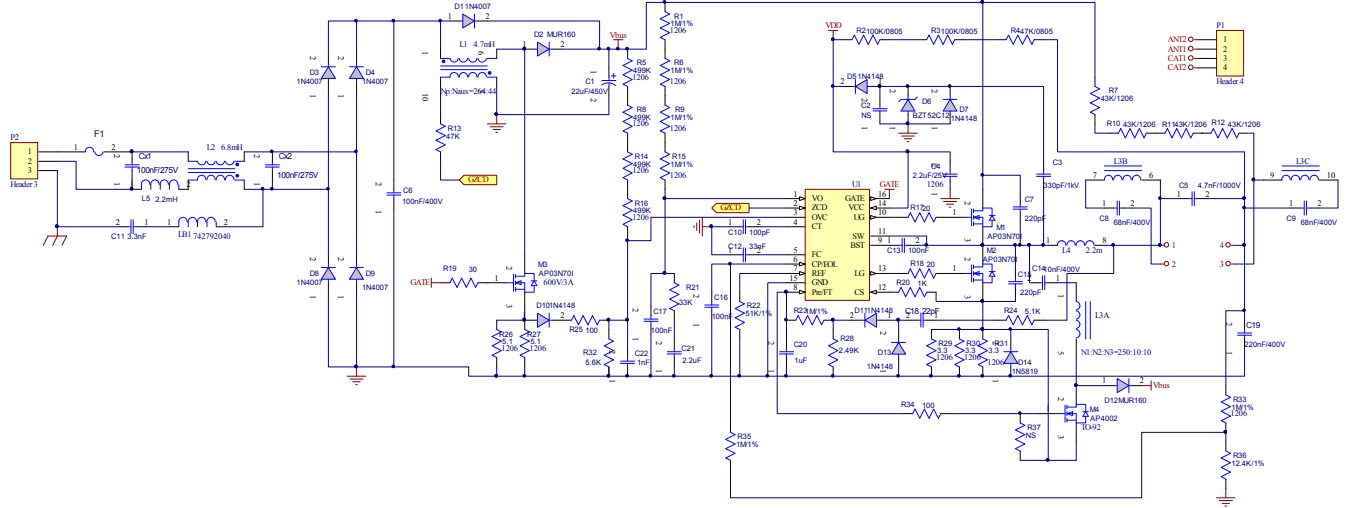

**EVHR2000-S-00A BILL OF MATERIALS**

Qty	Ref	Value	Description	Package	Manufacturer	Part Number
1	C1	22 $\mu$ F/450V	Electrolytic Capacitor;450V; Electrolytic;DIP	DIP	江海	CD110-450V22
1	C2	NS				
1	C3	330pF/1kV	Capacitor;1000V	DIP	ANY	
1	C4	2.2 $\mu$ F/25V	Ceramic Capacitor; 25V;X7R;1206	1206	muRata	GRM31MR71E225KA93L
1	C5	4.7nF/1000V	Capacitor;1000V	DIP	法拉	MMKP82-1000V- 472P10JA
1	C6	100nF/400V	Capacitor;400V;CBB	DIP	Panasonic	ECQE4104KF
2	C7, C15	220pF	Ceramic Capacitor; 1000V;U2J;1206	1206	muRata	GRM31A7U3A221JW31D
2	C8, C9	68nF/400V	Capacitor;400V;CBB	DIP	Panasonic	ECQE400VDC683K
1	C10	100pF	Ceramic Capacitor; 50V;C0G;0603	0603	TDK	C1608COG1H101J
1	C11	3.3nF	Y Capacitor;2600V;20%	DIP	鸿科	JY10F332MY72N
1	C12	33nF	Ceramic Capacitor; 50V;X7R;0603;	0603	muRata	GRM188R71H333KA61D
3	C13, C16, C17	100nF	Ceramic Capacitor;50V;X7R;0603;	0603	TDK	C1608X7R1H104K
1	C14	10nF/400V	Capacitor;400V;CBB	DIP	Panasonic	ECQE4103KF
1	C18	22pF	Capacitor;6000V;5%	DIP	鸿科	3J07SL220JY72N
1	C19	220nF/400V	Capacitor;400V;CBB	DIP	Panasonic	ECQE4224KF
1	C20	1 $\mu$ F	Ceramic Capacitor; 25V;X7R;0805	0805	muRata	GRM21BR71E105KA99L
1	C21	2.2 $\mu$ F	Ceramic Capacitor; 16V;X7R;0805	0805	muRata	GRM21BR71C225KA12L
1	C22	1nF	Ceramic Capacitor; 50V;X7R;0603;	0603	muRata	GRM188R71H102KA01D
2	Cx1, Cx2	100nF/275V	Capacitor;275V	DIP	Carli	PX104K3ID19L270D9R
5	D1, D3, D4, D8, D9	1N4007	Diode;1000V;1A	DO-41	Diodes	1N4007
2	D2, D12	MUR160-T	Diode;600V;1A	DO-41	HQ	MUR160-T
5	D5, D7, D10,D11, D13	1N4148W	Diode;75V;0.15A;	SOD-123	Diodes	1N4148W
1	D14	1N5819HW	Schottky Diode,40V,1A	SOD-123	Diodes	1N5819
1	D6	BZT52C12	Zener Diode; 12V;5mA/500mW;	SOD-123	Diodes	BZT52C12
1	F1	SS-5-1A	Fuse;250V;1A	DIP	COOPER BUSSMANN	SS-5-1A
1	L1	4.7mH	PFC Inductor, EE16, Np:Ns=264:44	DIP	E-MEI	FX308
1	L2	7446121007	Common Chock, 6.8mH/1A	DIP	Würth	7446121007
1	L3	FX307	Preheat Transformer,EE16, Np:Ns1:NS2=250:10:10	DIP	E-MEI	FX307
1	L4	2.2mH	Resonant Inductor, EF20, Np=220	DIP	E-MEI	FX306

**EVHR2000-S-00A BILL OF MATERIALS (CONTINUED)**

Qty	Ref	Value	Description	Package	Manufacturer	Part Number
1	L5	2.2mH	Inductor;2.2mH;4.73;320mA	DIP	Würth	7447720222
1	LB1	742792040	Magnetic Bead	0805	Würth	742792040
3	M1, M2, M3	ITA02N60A	N-Channel Mosfet; 600V, 4.5/10V;	TO-220	IPS	ITA02N60A
1	M4	ITNCS1N60	N-Channel Mosfet; 600V;15/10V	TO-92	IPS	ITNCS1N60
1	P1		Header, 6-Pin			
1	P2		Header, 3-Pin			
7	R1, R6, R9, R15, R23, R33, R35	1M/1%	Film Resistor;1%;	1206	Yageo	RC1206FR-071ML
2	R2, R3,	100k/0805	Film Resistor;5%	0805	Yageo	RC0805JR-07100KL
1	R4	47k	Film Resistor;5%	0805	Yageo	RM10JN473
4	R5, R8, R14, R16	499k	Film Resistor;1%;	1206	Yageo	RC1206FR-07499KL
4	R7, R10, R11, R12	43k/1206	Resistor;1%;	1206	Royalohm	1206F4302T5E
1	R13	47k	Film Resistor;5%;1/10W	0603	LIZ	CR0603JA0473G
2	R17, R18	20	Film Resistor;5%;1/10W	0603	LIZ	CR0603JA0200G
1	R19	30	Film Resistor;1%;	0603	Yageo	RC0603FR-0730RL
1	R20	1k	Film Resistor;1%	0603	Yageo	RC0603FR-071KL
1	R21	33k	Film Resistor;1%;	0603	Yageo	RC0603FR-0733KL
1	R22	51k/1%	Film Resistor;1%	0603	SYN- TECH	RC0603FR-0751KL
1	R24	5.1k	Film Resistor;5%	0603	Yageo	RC0603JR-075K1L
1	R25	100	Film Resistor;1%;	1206	Yageo	RC1206FR-07100RL
2	R26, R27	5.1	Film Resistor;5%;	1206	Yageo	RC1206JR-075R1L
1	R28	2.49k	Film Resistor;1%	0603	Yageo	RC0603FR-072K49L
3	R29, R30, R31	3.3	Resistor;1%	1206	Royalohm	1206F330KT5E
1	R32	5.6k	Film Resistor;1%;	0603	Yageo	RC0603FR-075K6L
1	R34	100	Film Resistor;1%;	0603	Yageo	RC0603FR-07100RL
1	R36	12.4k/1%	Film Resistor;1%;	0603	Yageo	RC0603FR-0712K4L
1	R37	NS				
1	U1	HR2000	FL Controller	SOIC-16	MPS	HR2000

## MAGNETIC COMPONENTS

### A. FX306, Resonant Inductor (L4)

Electrical Diagram:

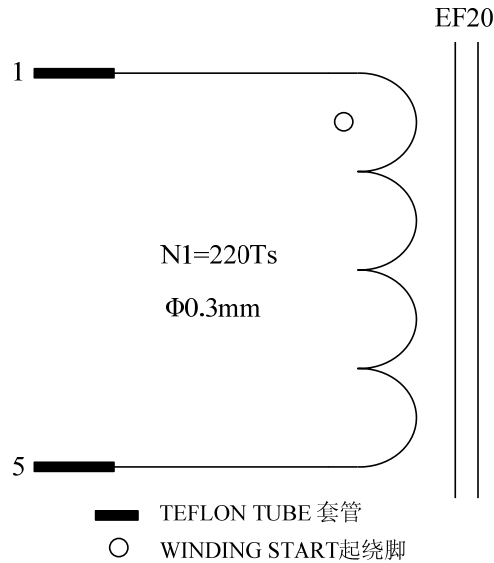

Winding Diagram

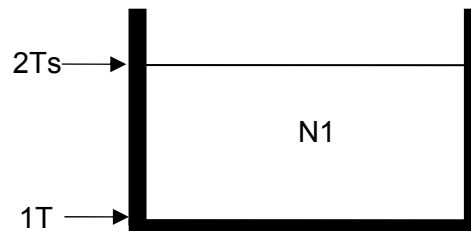

Winding Order

胶带圈数 (Tape Layer Number)	绕组顺序 (Winding No.)	始末脚位 (Start & End)	线径 $\phi$ (Magnet Wire)	圈数 (Turns)
1				
2	N1	1—5	0.3mm*1	220

Electric Characteristics

1	电感量 (Primary Inductance)	$L_p(1-5)$	2.2mH $\pm$ 10%	100kHz
2	匝比 (Turn Ratio)	N1	220	
3	抗电强度 (Electrical Strength)	Pri. Side ~ Sec. Side	AC: 3000V	1s, 1mA
		Pri. Side ~ Core	AC: 2000V	
		Sec. Side ~ Core	AC: 2000V	

## B. FX307, Preheating Transformer (L3)

### Electrical Diagram:

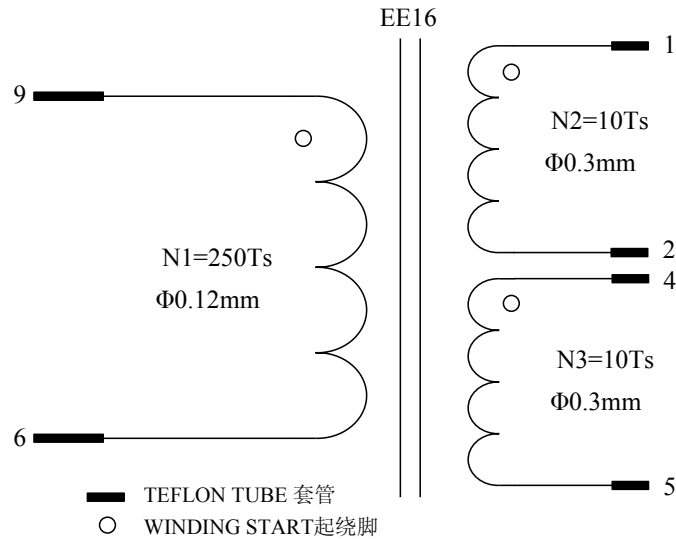

### Winding Diagram

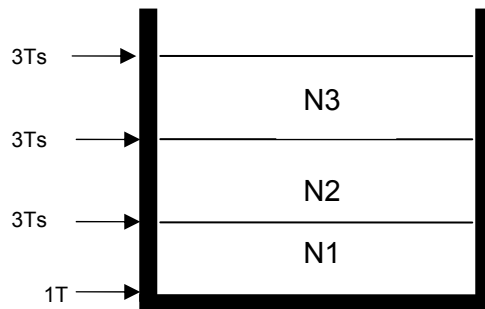

### Winding Order

胶带圈数 (Tape Layer Number)	绕组顺序 (Winding No.)	始末脚位 (Start & End)	线径 φ (Magnet Wire)	圈数 (Turns)
1				
3	N1	9—6	0.12mm*1	250
3	N2	1—2	0.3mm*1	10
3	N3	4—5	0.3mm*1	10

### Electric Characteristics

1	电感量 (Primary Inductance)	Lp(9—6)	>50mH	100kHz
2	匝比 (Turn Ratio)	N1:N2:N3	250:10:10	
3	抗电强度 (Electrical Strength)	Pri. Side ~ Sec. Side	AC: 3000V	1s, 1mA
		Pri. Side ~ Core	AC: 2000V	
		Sec. Side ~ Core	AC: 2000V	

### C. FX308, PFC Inductor (L1)

#### Electrical Diagram:

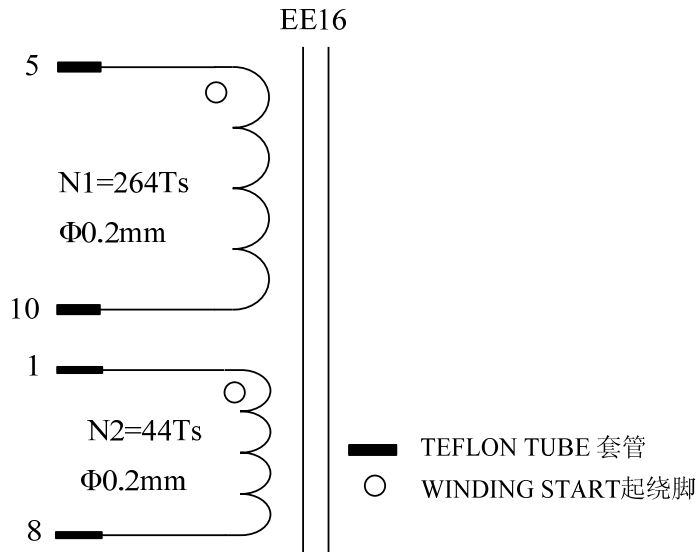

#### Winding Diagram

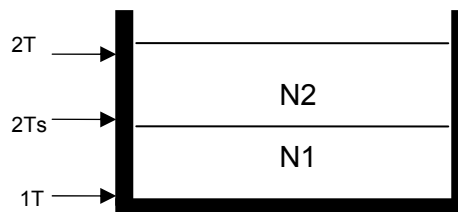

#### Winding Order

胶带圈数 (Tape Layer Number)	绕组顺序 (Winding No.)	始末脚位 (Start & End)	线径 φ (Magnet Wire)	圈数 (Turns)
1				
2	N1	5—> 10	0.2mm*1	264
2	N2	1—> 8	0.2mm*1	44

#### Electric Characteristics

1	电感量 (Primary Inductance)	Lp(1—5)	4.7mH±10%	100kHz
2	匝比 (Turn Ratio)	N1:N2	264:44	
3	抗电强度 (Electrical Strength)	Pri. Side ~ Sec. Side	AC: 3000V	1s, 1mA
		Pri. Side ~ Core	AC: 2000V	
		Sec. Side ~ Core	AC: 2000V	



## EVB TEST RESULTS

Performance waveforms are tested on the evaluation board.

$V_{IN} = 198V_{AC}$  to  $265V_{AC}$ , 16W Lamp,  $T_A = 25^{\circ}C$ , unless otherwise noted.

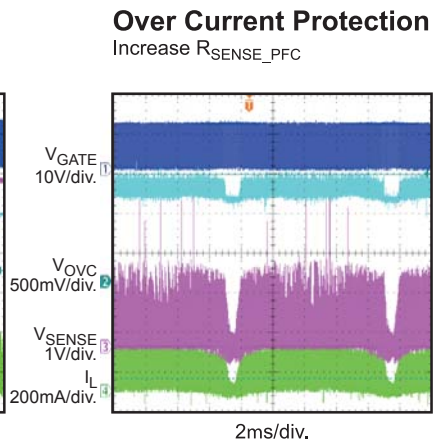
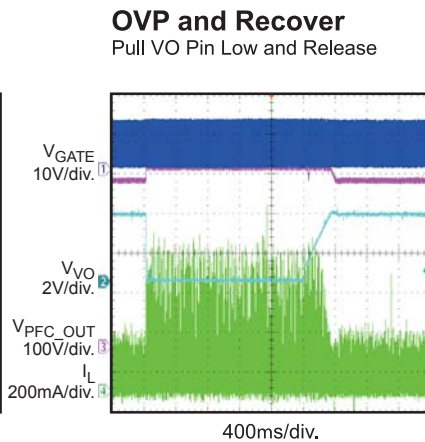
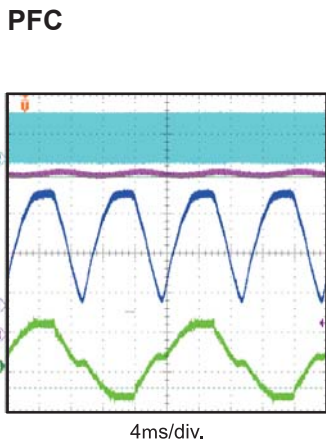
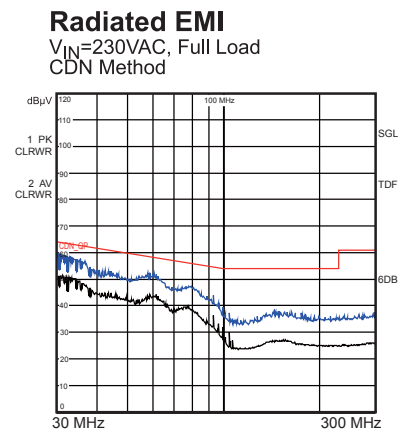
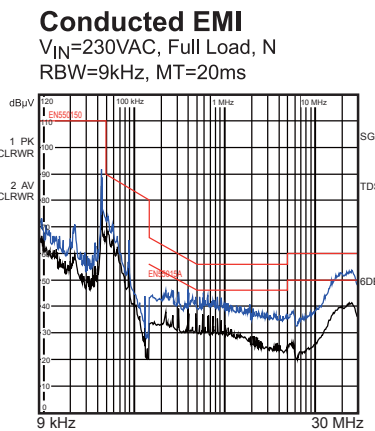
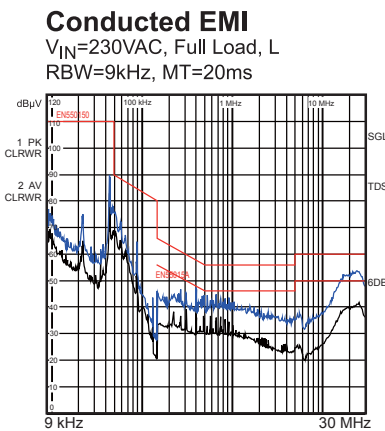
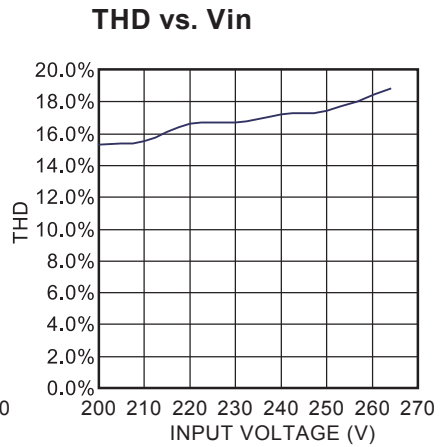
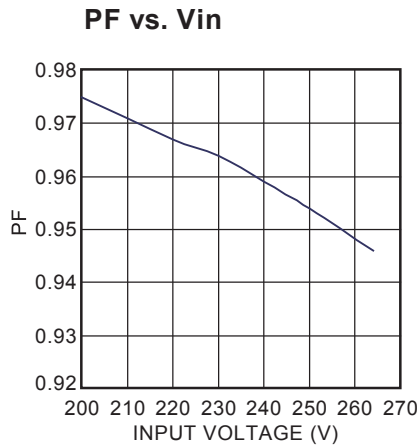
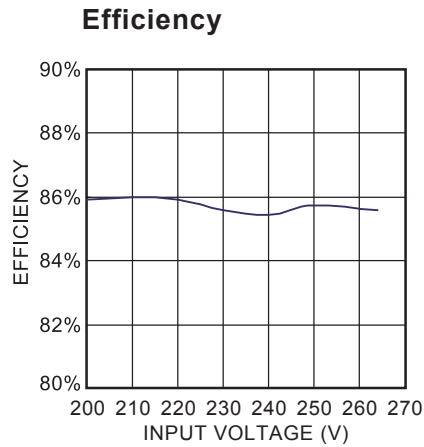

**EVB TEST RESULTS (continued)**

Performance waveforms are tested on the evaluation board.

 $V_{IN} = 198V_{AC}$  to  $265V_{AC}$ , 16W Lamp,  $T_A = 25^{\circ}C$ , unless otherwise noted.

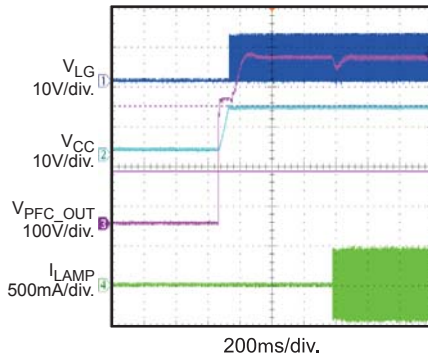
**Start Up**

**Preheat & Ignition**

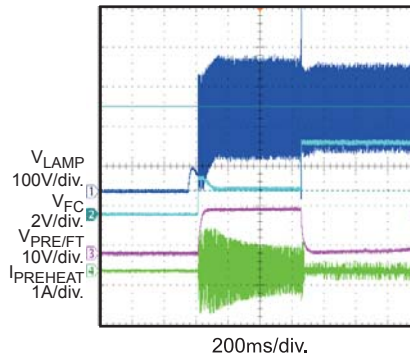
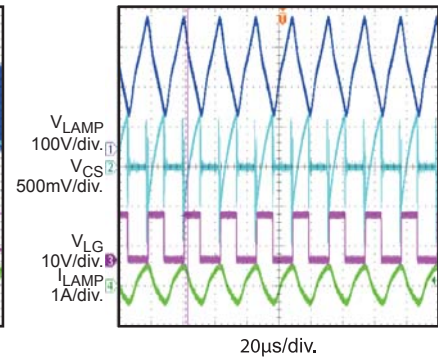
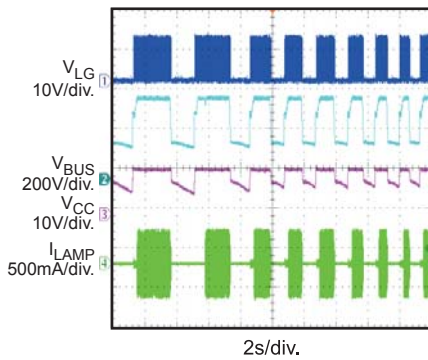
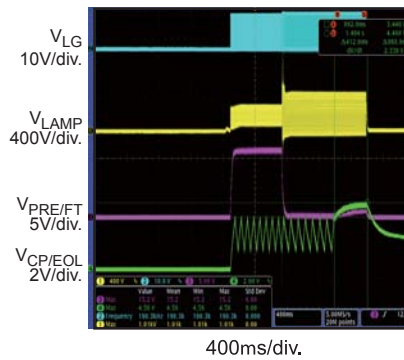
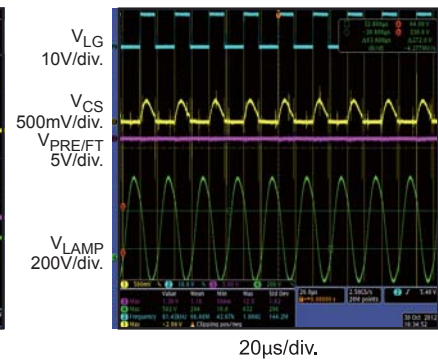
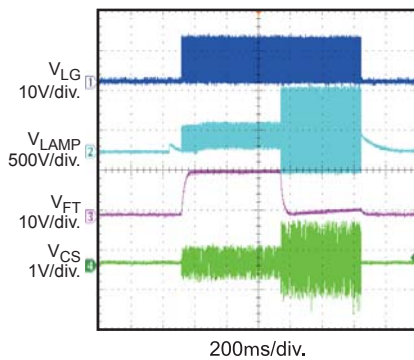
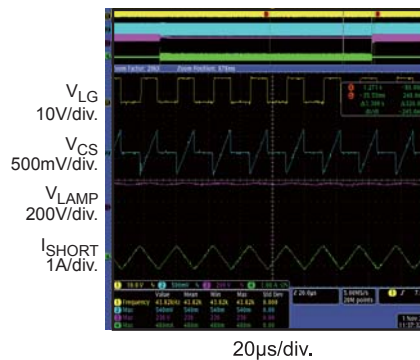
Controlled Preheat Time, Frequency, Current/Lamp Voltage

**Burn State**

**Quick Power On/Off**

**EOL Protection**

**Capacitive Mode Protection (Always Soft Switching)**

**Open Lamp Protection**

**Short Lamp and Recover**

**HARMONIC DATA**

Vin (Vac/Hz)	Pin(W)	Power Factor	THD (%)	
200/50	22.6	0.975	15.3	
<b>EN 61000-3-2/2000 active power <math>\geq</math> 25W, class C(%)</b>				
Harmonic Order	Measured Data (%)	Test Result (Pass/Fail)		
3	30* $\lambda$	13.70	Pass	
5	10	4.80	Pass	
7	7	4.10	Pass	
9	5	1.70	Pass	
11~39	3	1.70	Pass	

Vin (Vac/Hz)	Pin(W)	Power Factor	THD (%)	
220/50	22.33	0.967	16.6	
<b>EN 61000-3-2/2000 active power <math>\geq</math> 25W, class C (%)</b>				
Harmonic Order	Measured Data (%)	Test Result (Pass/Fail)		
3	30* $\lambda$	15	Pass	
5	10	5.40	Pass	
7	7	3.80	Pass	
9	5	1.70	Pass	
11~39	3	1.10	Pass	

Vin (Vac/Hz)	Pin(W)	Power Factor	THD (%)	
264/50	22.04	0.946	18.80	
<b>EN 61000-3-2/2000 active power <math>\geq</math> 25W, class C(%)</b>				
Harmonic Order	Measured Data (%)	Test Result (Pass/Fail)		
3	30* $\lambda$	17.10	Pass	
5	10	6.40	Pass	
7	7	3.50	Pass	
9	5	1.00	Pass	
11~39	3	0.40	Pass	

## SURGE TEST RESULT

Line to Line 500V and Line to Power Earth 1kV surge test was completed. Input voltage was set at 230Vac/50Hz. Output was loaded at full load and operation was verified following each surge event.

Surge Level (V)	Input Voltage (Vac)	Injection Location	Injection Phase (°)	Test Result (Pass/Fail)
±500V	230	L to N	0	Pass
±500V	230	L to N	90	Pass
±500V	230	L to N	180	Pass
±500V	230	L to N	270	Pass
±1000V	230	L to PE	0	Pass
±1000V	230	L to PE	90	Pass
±1000V	230	L to PE	180	Pass
±1000V	230	L to PE	270	Pass
±1000V	230	N to PE	0	Pass
±1000V	230	N to PE	90	Pass
±1000V	230	N to PE	180	Pass
±1000V	230	N to PE	270	Pass

# PRINTED CIRCUIT BOARD LAYOUT

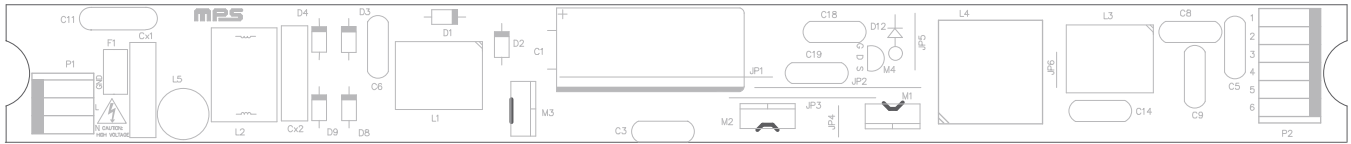

Figure 1—Top Silk Layer

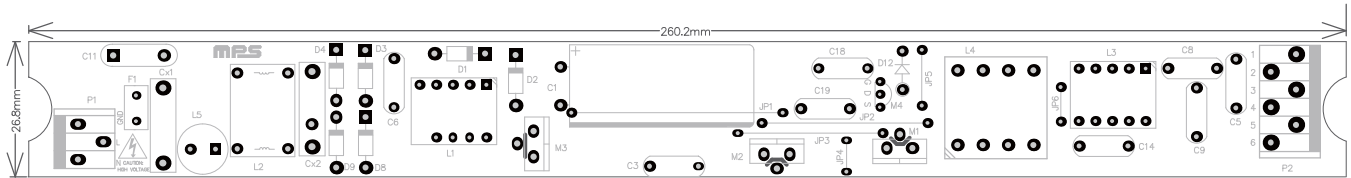

Figure 2—Top Layer

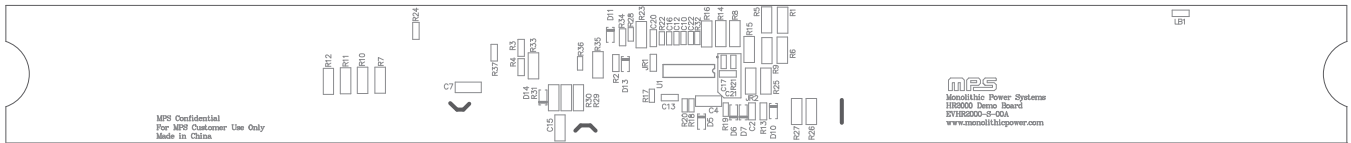

Figure 3—Bottom Silk Layer

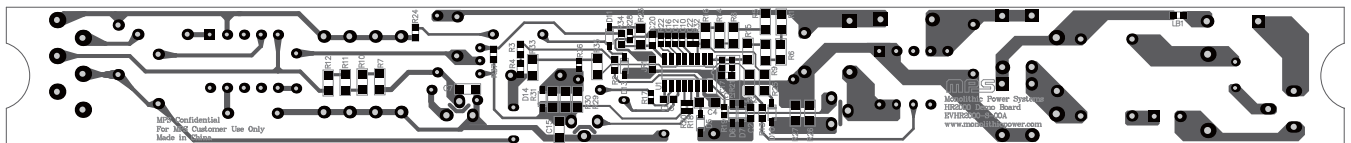

Figure 4—Bottom Layer

## QUICK START GUIDE

1. Connect the fluorescent lamp to EVB's connector 'P2', one side of terminals to '1' and '2' and the other side of terminals to '3' and '4';
2. Preset the AC power supply to  $198V \leq AC \text{ input} \leq 264V$ ; turn off the AC power supply.
3. Connect the AC power supply to 'P1';
4. Turn on the AC power supply, the lamp should be ignited.

**NOTICE:** The information in this document is subject to change without notice. Please contact MPS for current specifications. Users should warrant and guarantee that third party Intellectual Property rights are not infringed upon when integrating MPS products into any application. MPS will not assume any legal responsibility for any said applications.