

DESCRIPTION

The EVHFC0400-S-00B Evaluation Board is designed to demonstrate the capabilities of HFC0400. HFC0400 is a fixed-frequency current mode controller with built-in slope compensation. At light load condition, it freezes the peak current and reduces its switching frequency down to 25kHz. As a result, it offers excellent efficiency at light load. At very light load, the controller enters burst mode. So very low standby power consumption can be achieved.

The EVHFC0400-S-00B is designed for TV monitor and it typically drives 39W with dual outputs. One is 16V_{TYP}, 1.5A load and the other is 5V_{TYP}, 3A load from 90V_{AC}/60Hz to 265V_{AC}/50Hz.

The EVHFC0400-S-00B has excellent efficiency and meets 2kV IEC61000-4-5 surge immunity and EN55022 conducted EMI requirements. HFC0400 features variable protections like Thermal Shutdown (TSD), Vcc under Voltage Lockout (UVLO), Over Load Protection (OLP), Over Voltage Protection (OVP), Over Temperature Protection (OTP) and Brown-Out Protection.

HFC0400 is available in the SOIC8-7A package.

ELECTRICAL SPECIFICATION

Parameter	Symbol	Value	Units
Supply Voltage	V _{AC}	90 - 265	V _{AC}
Output Voltage 1	V _{OUT1}	5.0	V
Output Current 1	I _{OUT1}	3.0	A
Output Voltage 2	V _{OUT2}	16.0	V
Output Current 2	I _{OUT2}	1.5	A

FEATURES

- Fixed-frequency current mode control operation with built-in slope compensation.
- Frequency Foldback down to 25kHz at light load condition
- Burst Mode for low standby power consumption
- Frequency jittering for a reduced EMI signature
- X-CAP discharge function
- Internal high voltage current source
- VCC Under Voltage Lockout with Hysteresis (UVLO)
- Brown-Out Protection on HV pin
- Over Load Protection with programmable delay
- Latch-off for external Over Voltage Protection(OVP) and Over Temperature Protection(OTP) on TIMER Pin
- Thermal Shutdown (auto restart with hysteresis)
- Short Circuit Protection
- Programmable soft start

APPLICATIONS

- TV and Monitors.

All MPS parts are lead-free and adhere to the RoHS directive. For MPS green status, please visit MPS website under Quality Assurance.

"MPS" and "The Future of Analog IC Technology", are Registered Trademarks of Monolithic Power Systems, Inc..

EVHFC0400-S-00B EVALUATION BOARD

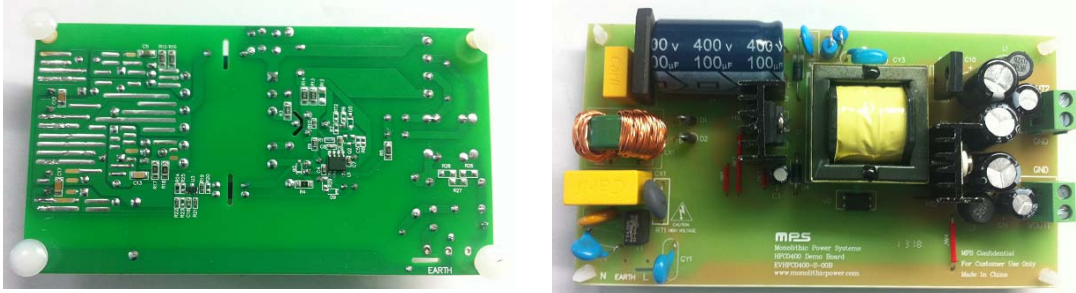

(L x W x H) 130mm x 70mm x 30mm

Board Number	MPS IC Number
EVHFC0400-S-00B	HFC0400GS

VALUATION BOARD SCHEMATIC

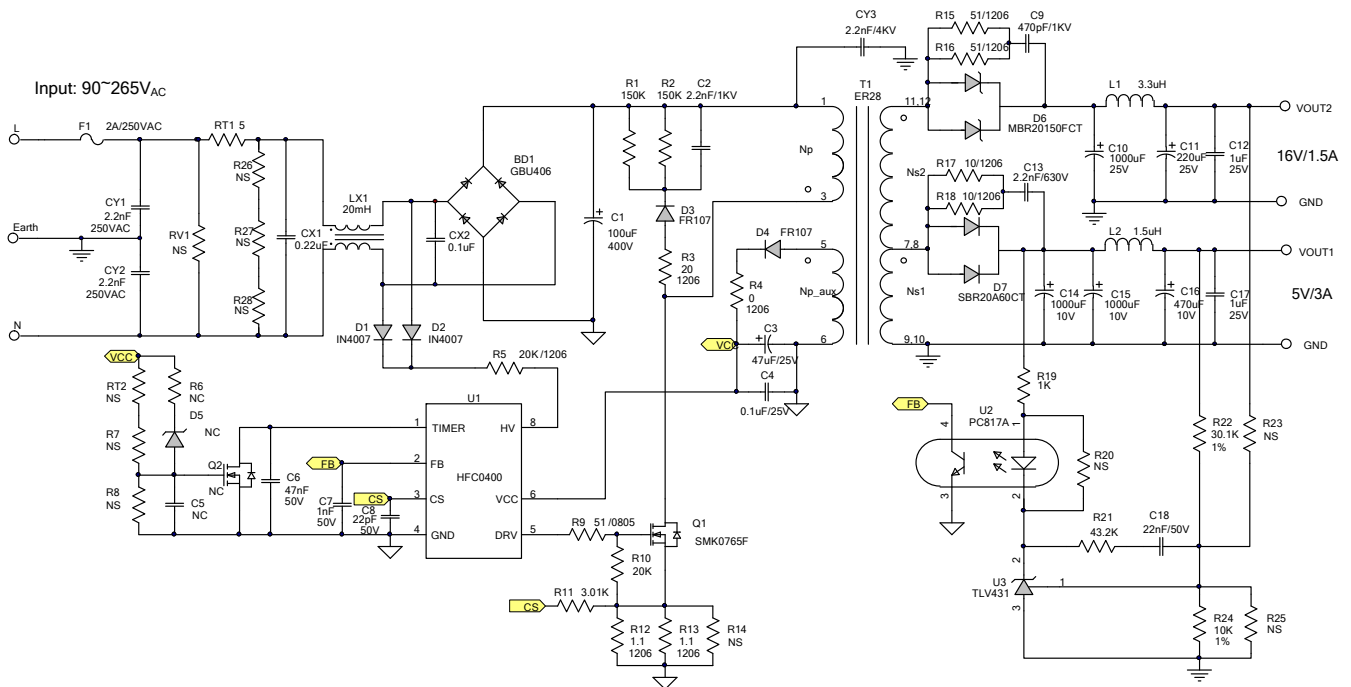

EVHFC0400-S-00B BILL OF MATERIALS

Qty	Ref	Value	Description	Package	Manufacturer	Part Number
1	BD1	GBU406	Diode;600V;4A	DIP	Diodes	GBU406
1	C1	100 μ F	Electrolytic Capacitor; 400V	DIP	Jianghai	CD263-400V100
1	C2	2.2nF	Capacitor;1000V	DIP	Any	
1	C3	47 μ F	Electrolytic Capacitor; 25V	DIP	Jianghai	CD28L-25V47
1	C4	0.1 μ F	Ceramic Capacitor; 25V;X7R	0603	Yageo	CC0603KRX7R8BB104
0	C5	NS				
1	C6	47nF	Ceramic Capacitor; 50V;X7R	0603	muRata	GRM188R71H473KA61D
1	C7	1nF	Ceramic Capacitor; 50V;X7R	0603	muRata	GRM188R71H102KA01D
1	C8	22pF	Ceramic Capacitor; 50V;C0G	0603	muRata	GRM1885C1H220JA01D
1	C9	470pF	Ceramic Capacitor; 1000V;U2J	1206	muRata	GRM31B7U3A471JW31L
1	C10	1000 μ F	Electrolytic Capacitor; 25V;	DIP	Panasonic	
1	C11	220 μ F	Electrolytic Capacitor; 25V;	DIP	Jianghai	CD287-25V220
2	C12, C17	1 μ F	Ceramic Capacitor; 25V;X7R	1206	muRata	GRM31MR71E105KA01
1	C13	2.2nF	Ceramic Capacitor; 250V;X7R	1206	Any	
2	C14, C15	1000 μ F	Electrolytic Capacitor; 10V	DIP	Jianghai	CD287-10V1000
1	C16	470 μ F	Electrolytic Capacitor; 10V	DIP	Jianghai	CD287-10V470
1	C18	22nF	Ceramic Capacitor; 50V;X7R	0603	muRata	GRM188R71H223KA01D
1	CX1	0.22 μ F	Film Capacitor; 275V;10%	DIP	Carli	PX224K3ID49L270D9R
1	CX2	0.1 μ F	Film Capacitor; 275V;10%	DIP	Carli	PX104K3IC39L270D9R
2	CY1, CY2	2.2nF	Y Capacitor; 250V;20%	DIP	Hongke	JY09F222ML72N
1	CY3	2.2nF	Capacitor;4000V;20%	DIP	Hongke	JN12E222MY02N
2	D1, D2	1N4007	Diode;1000V;1A	DO-41	Diodes	1N4007
2	D3,D 4	FR107	Diode;1000V;1A	DO-41	Diodes	FR107
0	D5, D8, D9	NS				
1	D6	MBR20150FCT	Diode;150V;20A	TO- 220AB	PANJIT	MBR20150FCT

EVHFC0400-S-00B BILL OF MATERIALS (continued)

Qty	Ref	Value	Description	Package	Manufacturer	Part Number
1	D7	SBR20A60CT	Diode;60V;20A	TO-220AB	Diodes	SBR20A60CT
1	F1	SS-5-2A	Fuse;250V;2A	DIP	COOPER BUSSMANN	SS-5-2A
1	L1	3.3 μ H	Inductor;3.3 μ H; 25mOhm;2.66A	DIP	TOKO	8RHB2-#822LY-3R3M
1	L2	1.5 μ H	Inductor;1.5 μ H; 10 mOhm;7A	DIP	Würth	744732015
1	LX1	30mH	Common Inductor; 1.5A;	DIP	Emei	TP4M30-02
1	Q1	SMK0765F	Mosfet;650V;7A	TO-220F-3L	AUK	SMK0765F
0	Q2	NS				
2	R1, R2	150k	Resistor;1%;1W	DIP	Any	
1	R3	20 Ω	Film Resistor; 5%;1/4W	1206	Royalohm	1206J0200T5E
1	R4	0	Resistor;5%	1206	Yageo	RC12065JR-070RL
1	R5	20k	Film Resistor; 5%;1/4W	1206	LIZ	CR1206J40203G
1	R9	51	Resistor; 5%;1/8W;	0805	Yageo	RC0805JR-0751RL
1	R10	20k	Film Resistor; 5%;	0603		653610846CR03T03705NJ20K
1	R11	3.01k	Film Resistor;1%	0603	Yageo	RC0603FR-073K01L
2	R13, R14	1.1	Film Resistor;1%	1206	Yageo	RC1206FR-071R1L
2	R15, R16	51	Film Resistor;1%	1206	Yageo	RC1206FR-0751RL
2	R17, R18	10	Film Resistor; 5%;1/4	1206	Yageo	CR1206JR-0710R
1	R19	1k	Film Resistor;5%	0603		0603SAJ0102T5E
1	R21	43.2k	Film Resistor; 1%;	0603	Yageo	RC0603FR-0743K2L
1	R22	30.1k	Film Resistor; 1%;	0603	Yageo	RC0603FR-0730K1L
1	R24	10k	Film Resistor; 1%;	0603	Yageo	RC0603FR-0710KL
0	R6, R7, R8, R14, R20, R23, R25, R26, R27, R28, R29	NS				

EVHFC0400-S-00B BILL OF MATERIALS (continued)

Qty	Ref	Value	Description	Package	Manufacturer	Part Number
1	RT1	5	Resistor, NTC	DIP	Xingshun	5D2-10
1	RT2	NS				
1	RV1	TVR10431	Varistor	DIP	TKS	TVR10431KSY
1	T1		Transformer;894µH; Np:Naux:Ns1:Ns2 =64:10:4:8	ER28	Emei ⁽¹⁾	FX0312
1	U1	HFC0400	Fixed Frequency Flyback Controller with ultra low Power consumption	SOIC8-7A	MPS	HFC0400, R2
1	U2	PC817A	Photocoupler; 1-Channel	DIP	Yiguang	PC817A
1	U3	TLV431	Shunt Regulator, 1.24V	SOT23	Guoda	TLV431ACDBZR

Note:

1. The website is www.emeigroup.com

TRANSFORMER STRUCTURE

Electrical Diagram

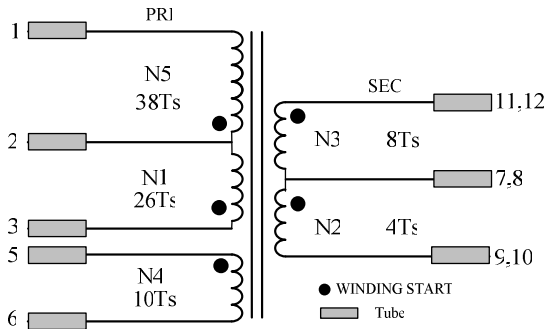

Winding Diagram

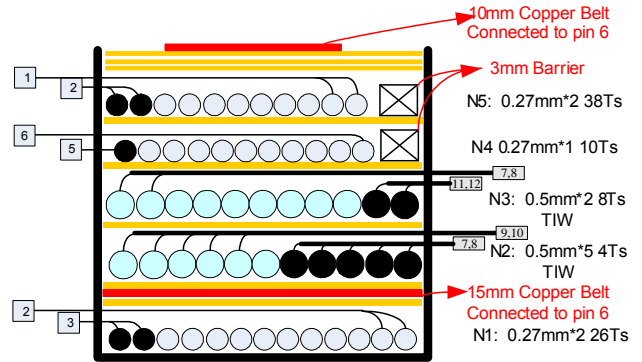

Notes:

1. Round one layer copper outside of the N1. And make sure the head and the tail of the copper and connected, then connected the copper to Ground Pin(Pin6).
2. Round one layer copper outside of the core air gap. And make sure the head and the tail of the copper and connected, then connected the copper to Ground Pin(Pin6).
3. Left 3mm barrier for N4 and N5 turns..

Pin Definition of Bobbin

Pin Out

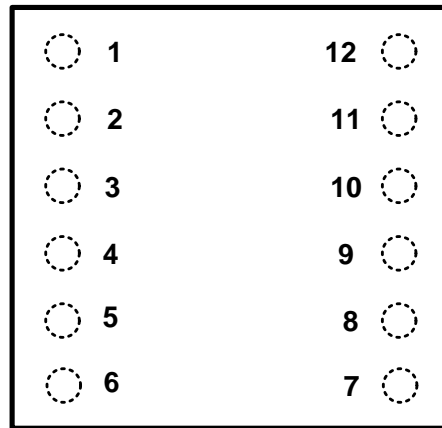

View from the top

Table 1—Electrical Characteristic

Parameter	Condition	Value
Primary Inductance	L _p (1-3)	894uH±5%
Core		EER28
Bobbin		EER28
Core Material		PC40 or equivalent
Turn Ratio	N1:N2:N3:N4:N5	26:4:8:10:38

Table 2—Winding Specification

Tape Turns	Winding No.	Start&End	Wire Diameter (mm)	Turns
1	N1	3→2	0.27×2	26
1	N2	7,8→9,10	0.5×5 TIW	4
1	N3	11,12→7,8	0.5×2 TIW	8
1	N4	5→6	0.27*1	10
3	N5	2→1	0.27×2	38

EVB TEST RESULTS

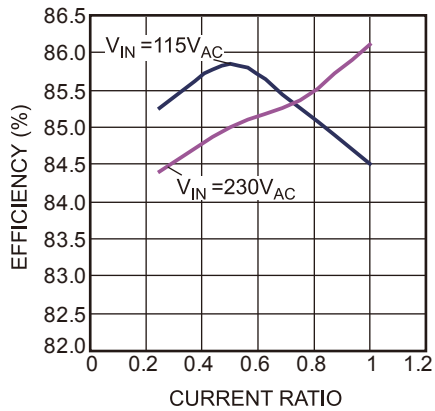
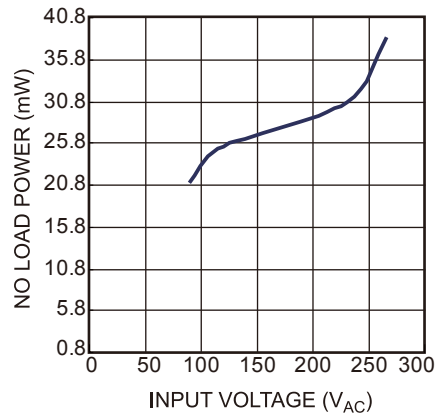
Efficiency vs. Load Current

No Load Power Consumption vs. Input Voltage

Load Regulation

Load condition		Input Voltage			
		90V _{AC}		265V _{AC}	
5V	16V	5V	16V	5V	16V
0.3A	0.3A	4.99V	15.41V	4.99V	15.38V
0.3A	1.5A	4.98V	14.99V	4.98V	14.97V
3A	0.3A	4.97V	16.59V	4.98V	16.71V
3A	1.5A	4.97V	15.82V	4.99V	15.65V

EVB TEST RESULTS

Performance waveforms are tested on the evaluation board.

$V_{IN} = 265V_{AC}$, $V_{OUT1} = 5V$, $V_{OUT2} = 16V$, full load, $T_A = 25^\circ C$, unless otherwise noted.

Stress

Steady State, Mosfet

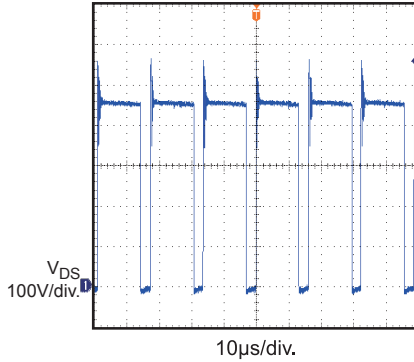

Stress

Steady State,
Output 1 Diode

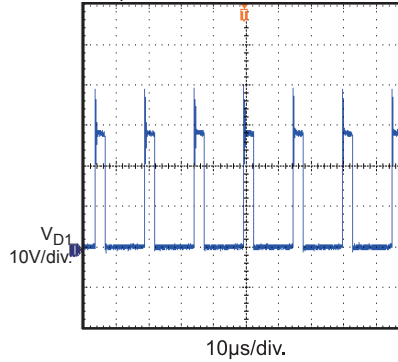

Stress

Steady State,
Output 2 Diode

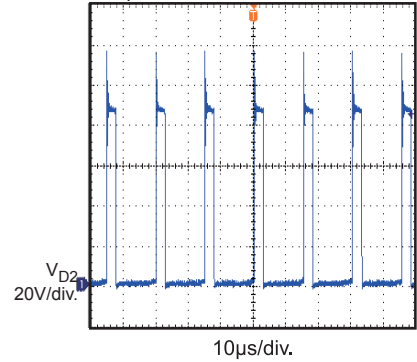

Stress

OVP, Mosfet

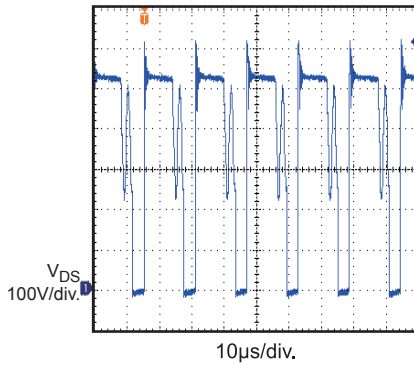

Stress

OVP, Output 1 Diode

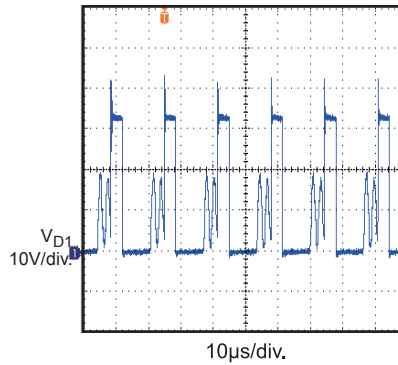

Stress

OVP, Output 1 Diode

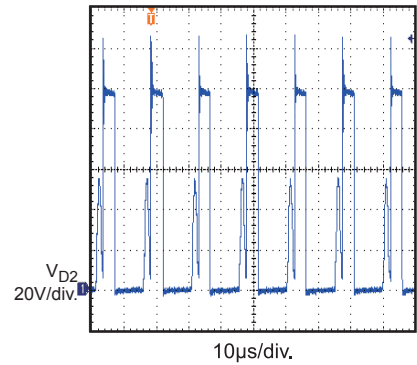

SCP

$V_{IN}=90V_{AC}$

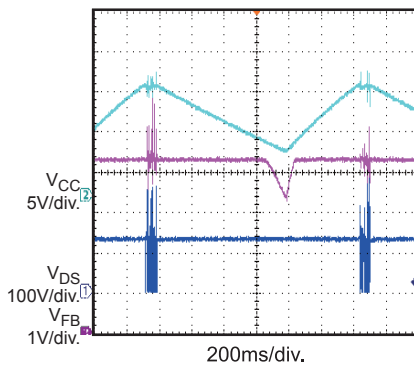

SCP

$V_{IN}=230V_{AC}$

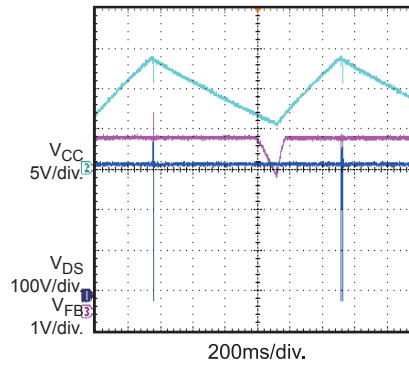

OVP

$V_{IN}=115V_{AC}$

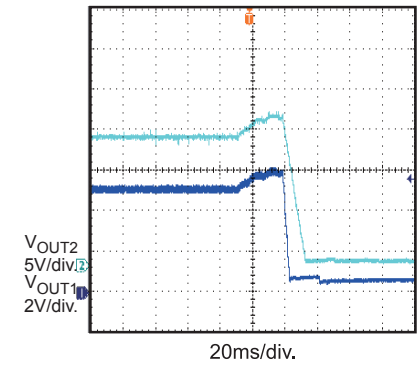

EVB TEST RESULTS *(continued)*

Performance waveforms are tested on the evaluation board.

$V_{OUT1} = 5V$, $V_{OUT2} = 16V$, full load, $T_A = 25^\circ C$, unless otherwise noted.

OVP

$V_{IN} = 230V_{AC}$

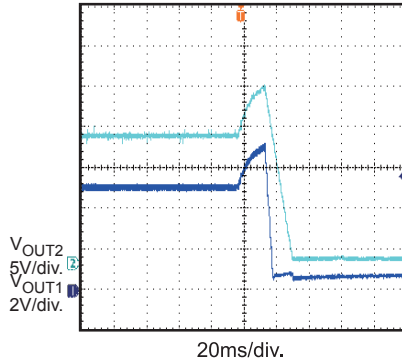

Output Ripple 1

$V_{IN} = 115V_{AC}$

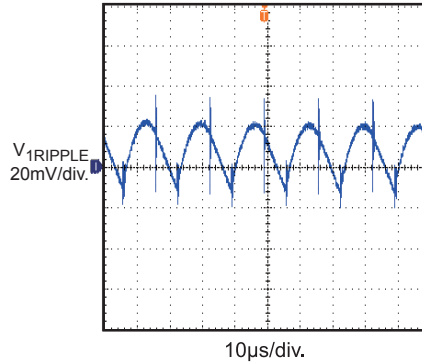

Output Ripple 1

$V_{IN} = 230V_{AC}$

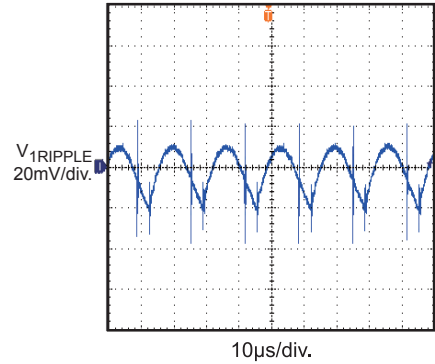

Output Ripple 2

$V_{IN} = 115V_{AC}$

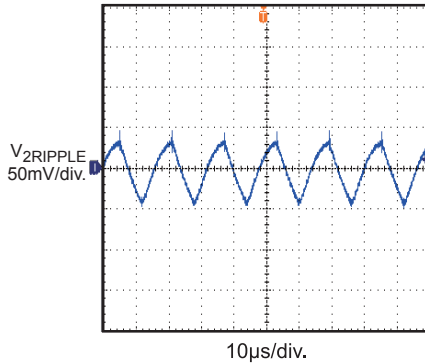

Output Ripple 2

$V_{IN} = 230V_{AC}$

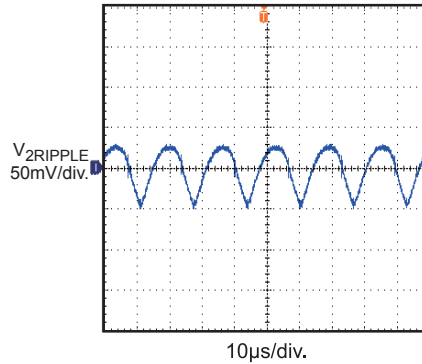

Turn On Delay

$V_{IN} = 90V_{AC}$

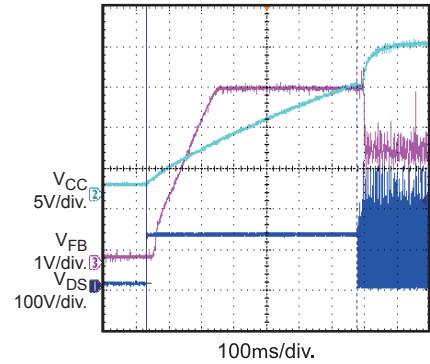

Turn On Delay

$V_{IN} = 265V_{AC}$

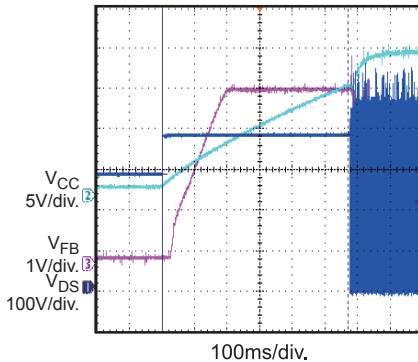

Rise Time

$V_{IN} = 90V_{AC}$

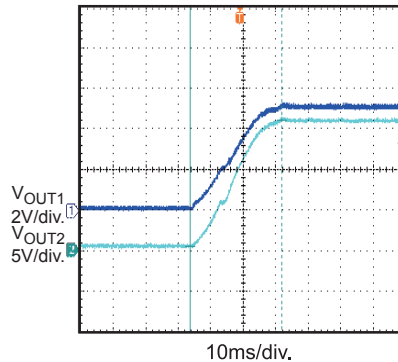

Rise Time

$V_{IN} = 265V_{AC}$

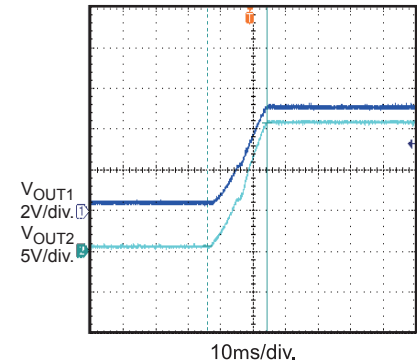

EVB TEST RESULTS *(continued)*

Performance waveforms are tested on the evaluation board.

$V_{OUT1} = 5V$, $V_{OUT2} = 16V$, full load, $T_A = 25^\circ C$, unless otherwise noted.

Start Up

$V_{IN}=115V_{AC}$

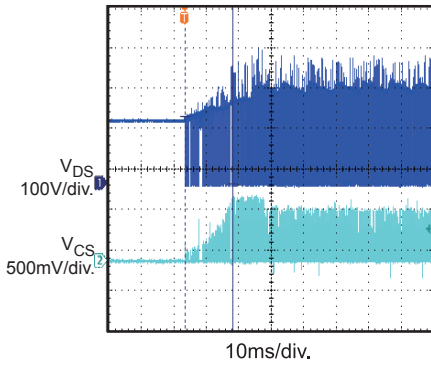

Start Up

$V_{IN}=230V_{AC}$

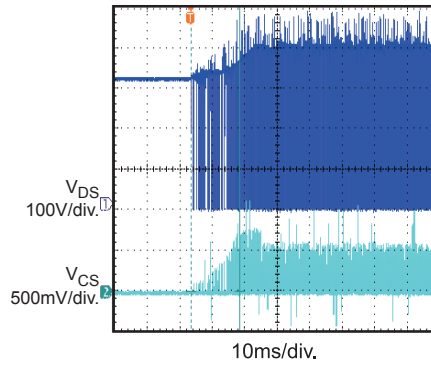

EMI

Three Line, 110V, L

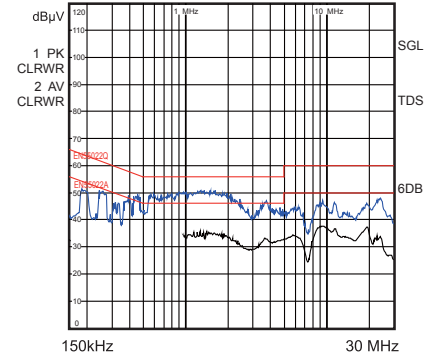

EMI

Three Line, 110V, N

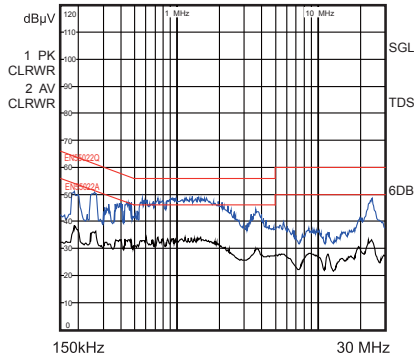

EMI

Three Line, 230V, L

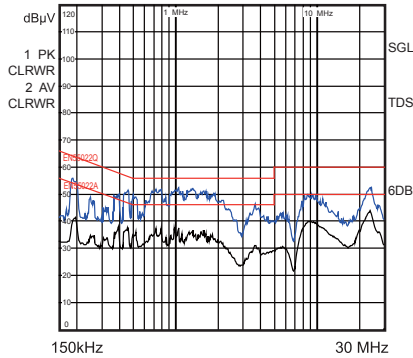

EMI

Three Line, 230V, N

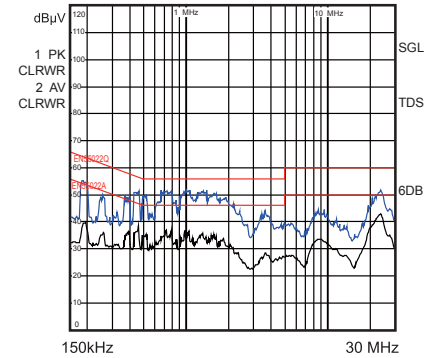

PRINTED CIRCUIT BOARD LAYOUT

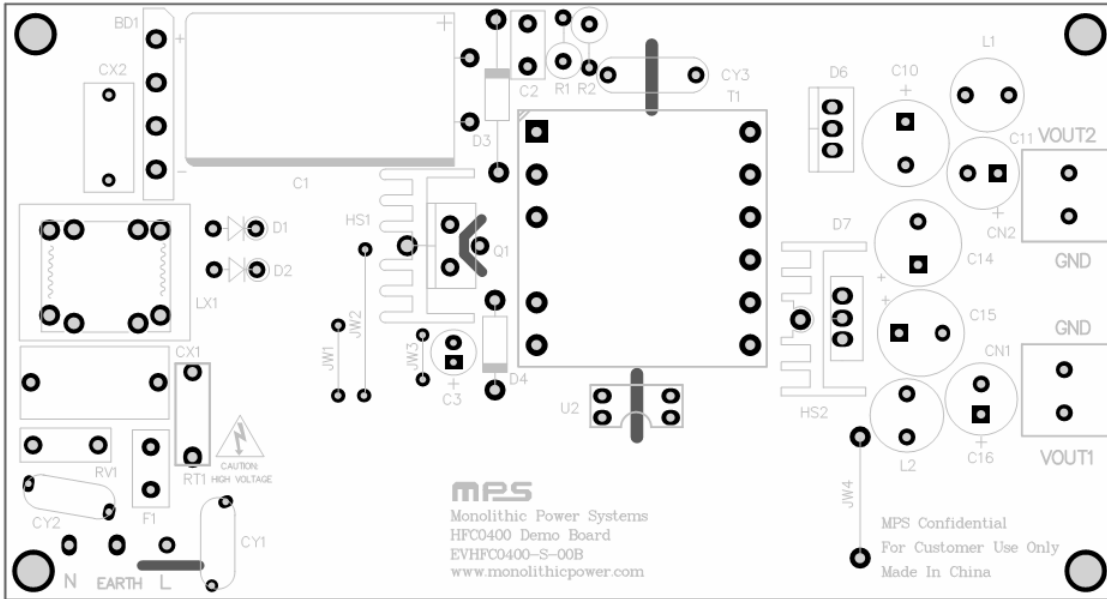

Figure 1 — Top Layer

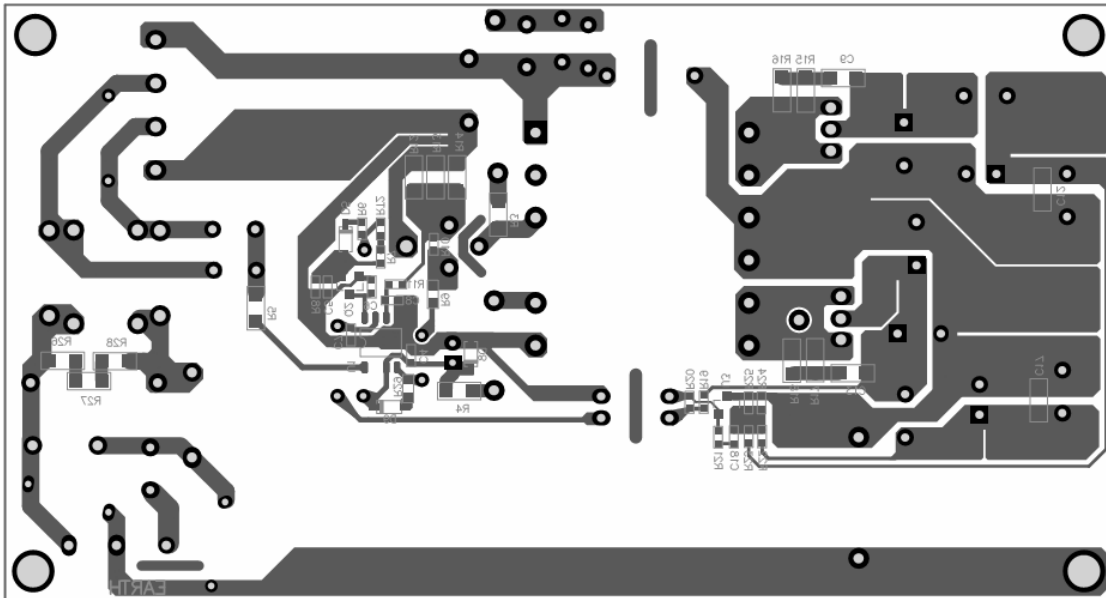

Figure 2 — Bottom Layer

QUICK START GUIDE

1. Preset Power Supply to $90V \leq V_{AC} \leq 265V$.
2. Turn Power Supply off.
3. Connect the power supply output to L and N pins respectively.
4. Connect the positive and negative terminals of the Load to VOUT and GND pins respectively.
5. Turn Power Supply on after making connections.

NOTICE: The information in this document is subject to change without notice. Please contact MPS for current specifications. Users should warrant and guarantee that third party Intellectual Property rights are not infringed upon when integrating MPS products into any application. MPS will not assume any legal responsibility for any said applications.