



EVHF920-S-00D

85VAC/60Hz~350VAC/50Hz
13.5V/0.3A;8V/50mA;8V/50mA
Off-line Switching Regulator

DESCRIPTION

HF920 is a flyback regulator with a monolithic 900V MOSFET. HF920 provides excellent power regulation in AC-DC applications that require high reliability. The switching frequency can be programmed with a single resistor. Also a special frequency doubling mode, designed for strong magnetizing application, can be enabled through a simple external setup.

EVHF920-S-00D evaluation board is specially designed for a better EMC performance with very few EMI filters, which provides reference to effective PCB design for the customer. It features an off-line wide input voltage (85VAC~350VAC) with triple outputs (13.5V/300mA, 8V/50mA, 8V/50mA), and is very suitable for power meter application with the need of three isolated power supplies.

EVHF920-S-00D can meet EN55022 conducted EMI requirements easily with frequency jittering function, as well as CISPR22 RE class B with the proper transformer design. It offers a full suite of protective features such as over-temperature protection, VCC under-voltage lockout, over-voltage protection, over-load protection and short-circuit protection.

ELECTRICAL SPECIFICATION

Parameter	Symbol	Value	Units
Input Voltage	V_{IN}	85 to 350	VAC
Output Voltage1	V_{OUT1}	13.5	V
Output Current1	I_{OUT1}	300	mA
Output Voltage2	V_{OUT2}	8	V
Output Current2	I_{OUT2}	50	mA
Output Voltage3	V_{OUT3}	8	V
Output Current3	I_{OUT3}	50	mA

FEATURES

- Wide input voltage (85VAC~350VAC)
- Triple isolated output power supplies
- Fixed switching frequency, programmable up to 150kHz
- Frequency doubling operation mode
- Excellent EMC performance
- External input PRO pin protection with hysteresis and auto-restart recovery
- Over Temperature Protection
- Over Voltage Protection on VCC
- Time-based Over Load Protection
- Short Circuit Protection

APPLICATIONS

- E-Meters
- Industrial controls
- Large appliances

All MPS parts are lead-free, halogen free and adhere to the RoHS directive. For MPS green status, please visit MPS website under Quality Assurance. "MPS" and "The Future of Analog IC Technology", are Registered Trademarks of Monolithic Power Systems, Inc.



High Voltage

Warning: Although this board is designed to satisfy safety requirements, the engineering prototype has not been agency approved. Therefore, all testing should be performed using an isolation transformer to provide the AC input to the prototype board.

EVHF920-S-00D EVALUATION BOARD



TOP VIEW

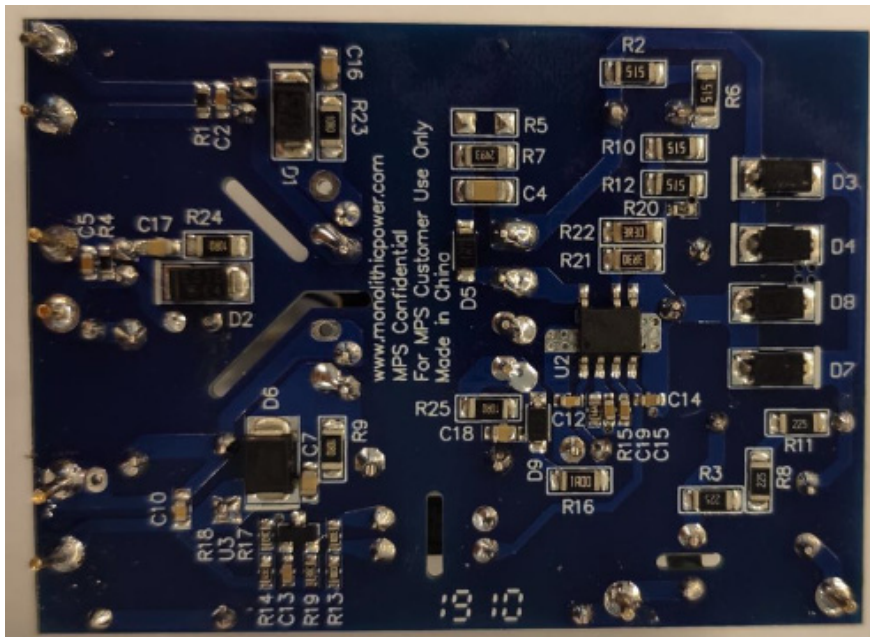

BOTTOM VIEW

(L x W x H) 65mm x 47mm x 22mm

Board Number	MPS IC Number
EVHF920-S-00D	HF920GSE

EVALUATION BOARD SCHEMATIC

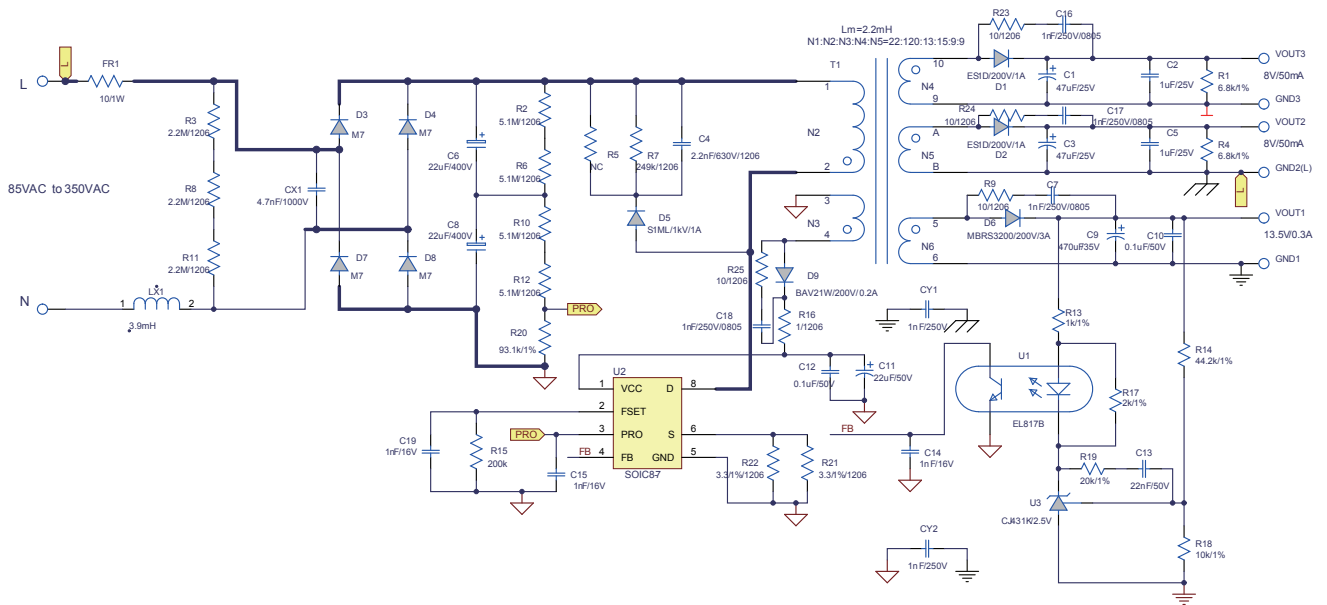

Figure 1: Schematic

EVHF920-S-00D BILL OF MATERIALS

Qty	Ref	Value	Description	Package	Manufacturer	Manufacturer_P/N
2	C1,C3	47 μ F	Electrolytic Capacitor;25V	DIP	Jianghai	CD28L-25V47
2	C2,C5	1 μ F	Ceramic Capacitor;25V;X7R	0603	Murata	GRM188R71E2105KA12D
1	C4	2.2nF	Ceramic Capacitor;630V;X7R	1206	Murata	GRM31BR72J222KW01L
2	C6,C8	22 μ F	Electrolytic Capacitor;400V	DIP	Rubycon	400PX22MEFC12.5X20
4	C7,C16,C17,C18	1nF	Ceramic Capacitor;250V;X7R	0805	Murata	GRM21AR72E102KW01D
1	C9	470 μ F	Ceramic Capacitor;35V	DIP	Jianghai	CD263-35V470
2	C10,C12	100nF	Ceramic Capacitor;50V	0603	Würth	885012206095
1	C11	22 μ F	Electrolytic Capacitor;50V	DIP	Rubycon	50YXM22MEFC5*11
1	C13	22nF	Ceramic Capacitor;50V	0603	Murata	GRM188R71H223KA01D
3	C14,C15,C19	1nF	Ceramic Capacitor;16V	0603	Würth	8.85012E+11
1	CX1	4.7nF	X Capacitor 1000V	DIP	法拉	MMKP82-1000V-472P1
2	CY1,CY2	1nF	Y Capacitor;250V;20%	DIP	Hongke	JNK09E102MY02N
2	D1,D2	ES1D	Schottky Diode;200V;1A	SMA	Diodes	Taiwan
4	D3,D4,D7,D8	M7	Diode;1000V;1A	SMA	Diodes	Toshiba
1	D5	S1ML	Diode;1000V;1A;	SOD123	Diodes	Taiwan
1	D6	MBRS3200T3G	Schottky Diode;200V;3A	SMB	Onsemi	MBRS3200TS3G
1	D9	BAV21W	Diode;200V;0.2A;	SOD123	Diodes	BAV21W-7-F
1	LX1	7447452392	3.9mH	DIP	Würth	7447452392
1	FR1	10	Fuse Resistor;5%;1/2W	DIP	CTC	FKN1WSJT-52-10R
2	R1,R4	6.8k	Film Resistor;1%	0603	Yageo	RC0603FR-076K8L
4	R2,R6,R10,R12	5.1M	Film Resistor;5%;1/4W	1206	Yageo	RI1206L515JT
3	R3,R8,R11	2.2M	Film Resistor;5%;1/4W	1206	Royalohm	1206J0225T5E
1	R7	249k	Film Resistor;5%;1/4W	1206	Yageo	RC1206FR-07249KL
4	R9,R23,R24,R25	10	Film Resistor;1%;1/4W	1206	Yageo	RC1206FR-0710RL

EVHF920-S-00D BILL OF MATERIALS (continued)

Qty	Ref	Value	Description	Package	Manufacturer	Manufacturer_P/N
1	R13	1k	Film Resistor;1%	0603	Yageo	RC0603FR-071KL
1	R14	44.2k	Film Resistor;1%	0603	Yageo	RC0603FR-0744K2L
1	R15	210k	Film Resistor;1%	0603	Yageo	RC0603FR-07210KL
1	R16	1	Film Resistor;1%	1206	Yageo	RC1206FR-071RL
1	R17	2k	Film Resistor;1%	0603	Yageo	RC0603FR-072KL
1	R18	10k	Film Resistor;1%	0603	Yageo	RC0603FR-0710KL
1	R19	20k	Film Resistor;1%	0603	Yageo	RC0603FR-0720KL
1	R20	93.1k	Film Resistor;1%	0603	Yageo	RC0603FR-0793K1L
2	R21,R22	3.3	Film Resistor;1%;1/4W	1206	Yageo	RC1206FR-073R3L
1	U2	HF920G SE	Flyback regulator with 900V integrated MOS	SOIC8-7 A	MPS	HF920GSE
1	U1	EL817B	Photocoupler;1-Channel	DIP	Everlight	EL817B
1	U3	CJ431	2.5V voltage reference	SOT23	Diodes	CJ431
	8	L,N,VOU T1, VOUT2, GND1,G ND2,Vout 3,GND3	Connector	1.0mm		
	1	JP1		28mm		
	1	JP2		22.6mm		
	1	Transformer		EE16 FX0553		

Notes:

 1) Emei transformer sample request please login on website: www.emeigroup.com

EVB TEST RESULTS

Performance waveforms are tested on the evaluation board.

$V_{IN} = 230VAC$, $V_{OUT1} = 13.5V$, $I_{OUT1} = 300mA$, $V_{OUT2} = V_{OUT3} = 8V$, $I_{OUT2} = I_{OUT3} = 50mA$, $T_A = 25^{\circ}C$, unless otherwise noted.

Efficiency

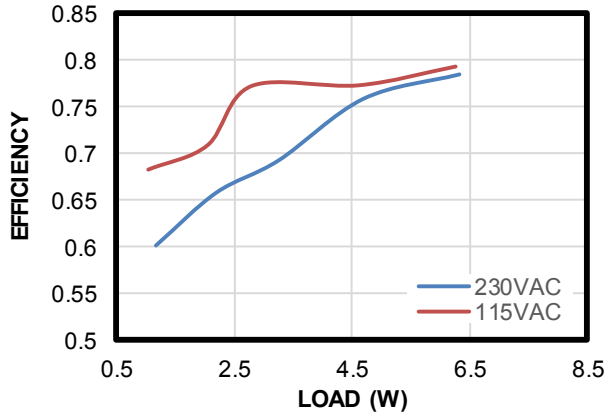

No Load Consumption

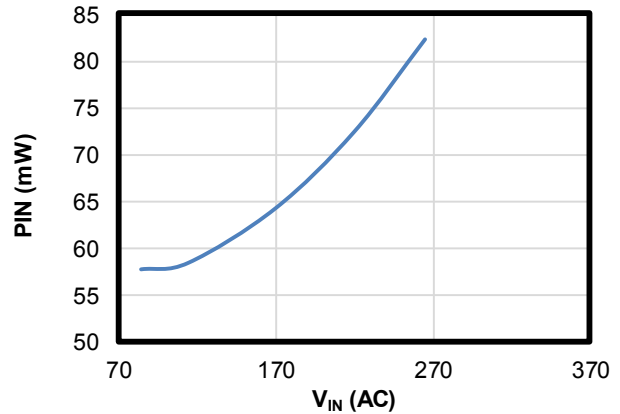

Power On

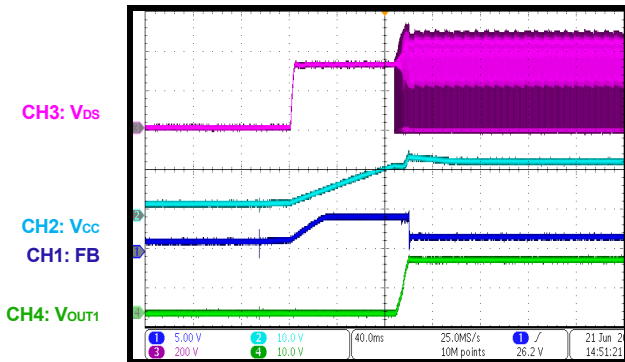

Power Off

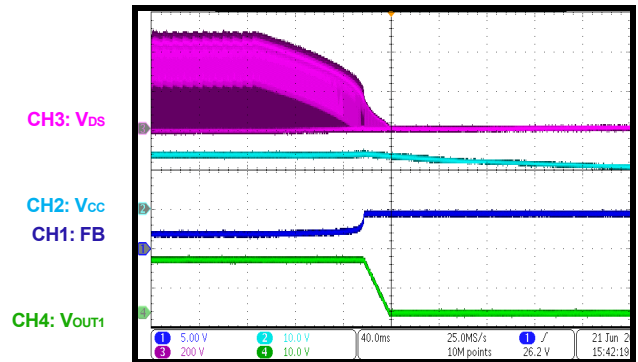

Normal Operation

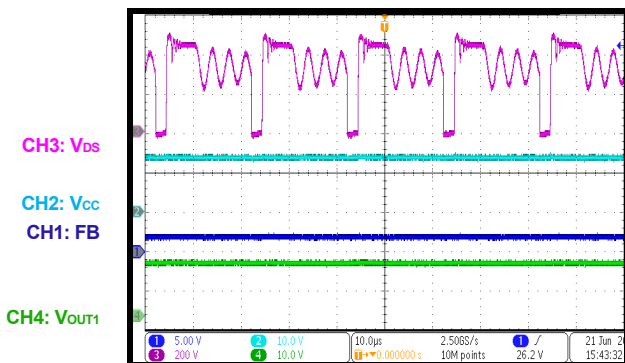

Short Circuit Entry

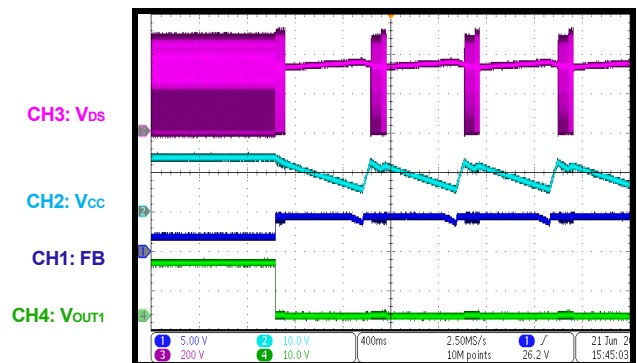

TYPICAL PERFORMANCE CHARACTERISTICS *(continued)*

Performance waveforms are tested on the evaluation board.

 $V_{IN} = 230VAC$, $V_{OUT1} = 13.5V$, $I_{OUT1} = 300mA$, $V_{OUT2} = V_{OUT3} = 8V$, $I_{OUT2} = I_{OUT3} = 50mA$, $T_A = 25^{\circ}C$, unless otherwise noted.

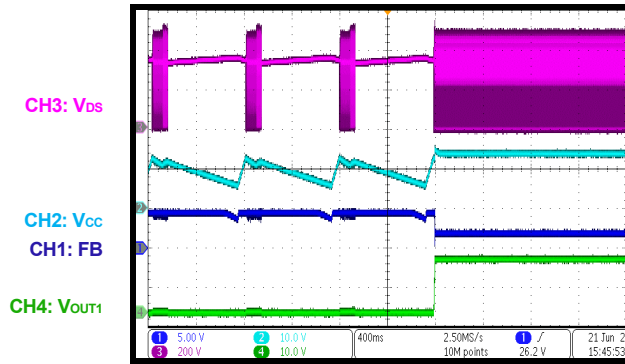
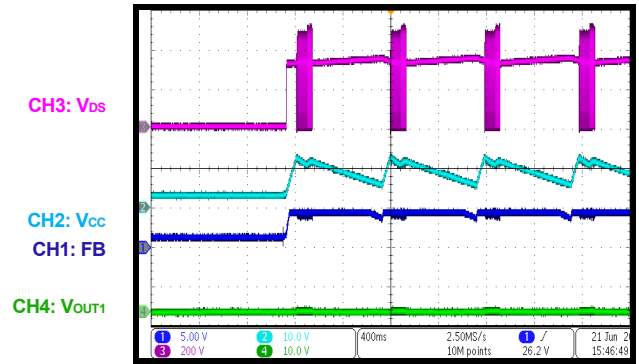
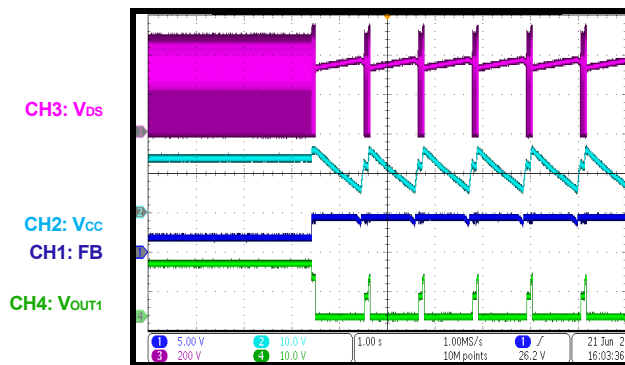
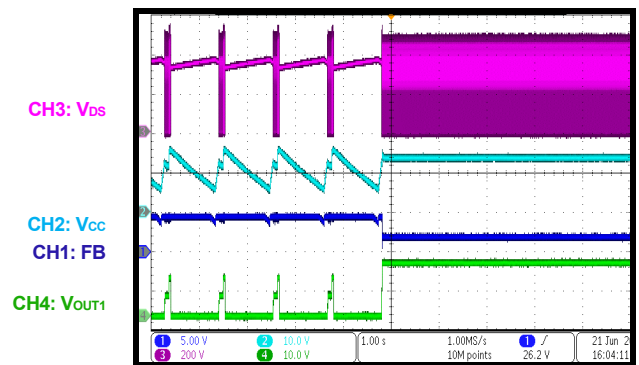
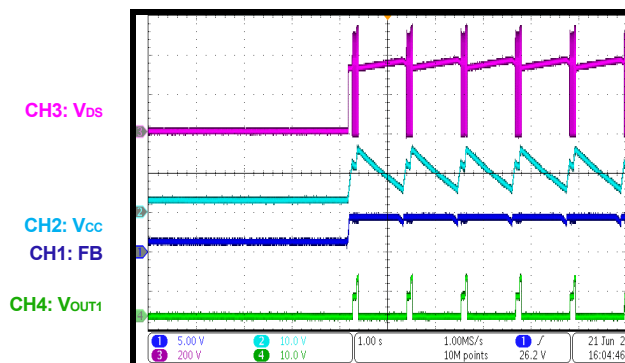
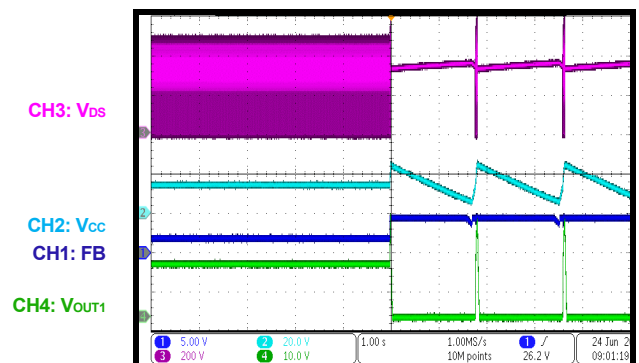
Short Circuit Recovery

Short Circuit Power On

OLP Entry

OLP Recovery

OLP Power On

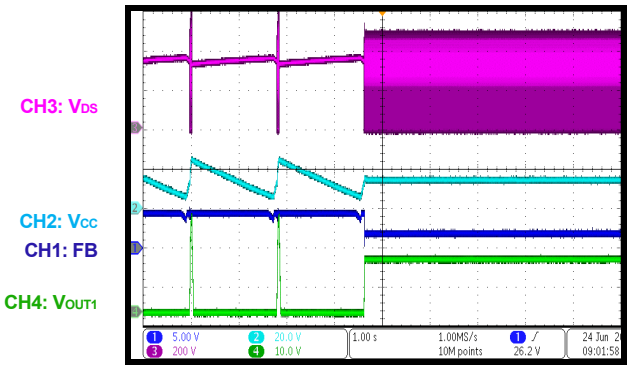
OVP Entry

TYPICAL PERFORMANCE CHARACTERISTICS *(continued)*

Performance waveforms are tested on the evaluation board.

$V_{IN} = 230VAC$, $V_{OUT1} = 13.5V$, $I_{OUT1} = 300mA$, $V_{OUT2} = V_{OUT3} = 8V$, $I_{OUT2} = I_{OUT3} = 50mA$, $T_A = 25^{\circ}C$, unless otherwise noted.

OVP Recovery



OVP Power On

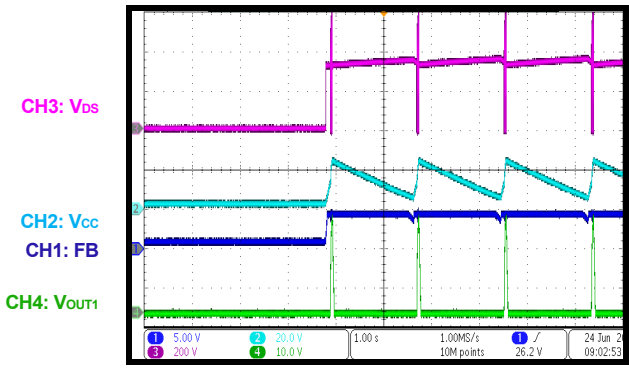

Conducted EMI

Two-Wire Input, L Line

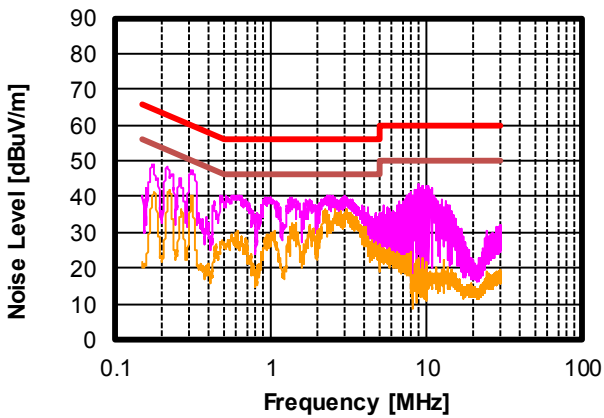

Conducted EMI

Two-Wire Input, N Line

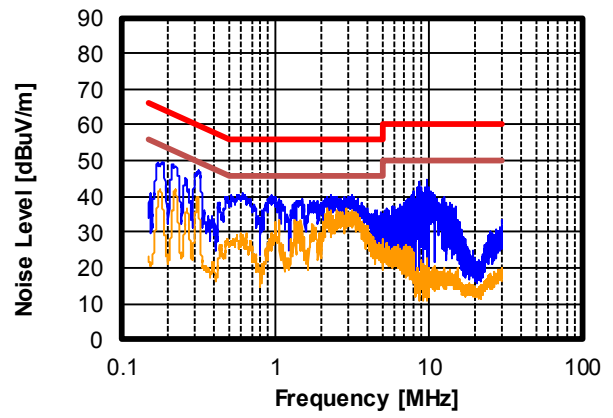

RE test result ($V_{IN} = 220VAC$, $V_{OUT1} = 13.5V$, $I_{OUT1} = 100mA$, $V_{OUT2} = V_{OUT3} = 8V$, $I_{OUT2} = I_{OUT3} = 50mA$.)

Horizontal

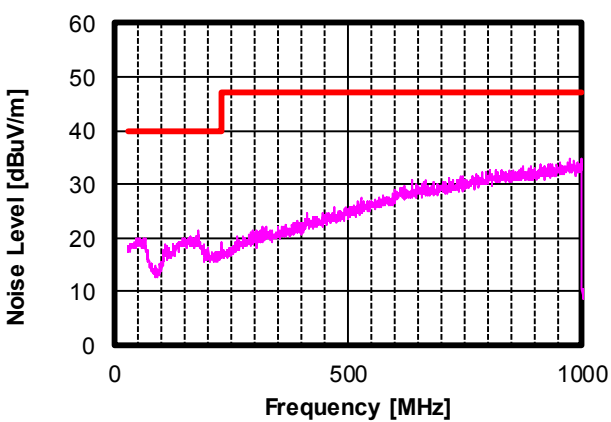

Vertical

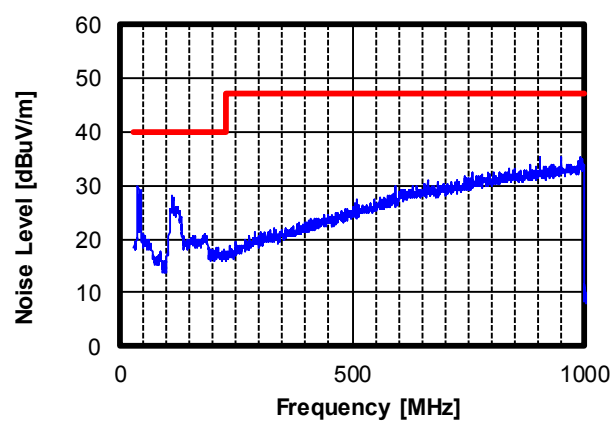

TRANSFORMER SPECIFICATION

Electrical Diagram

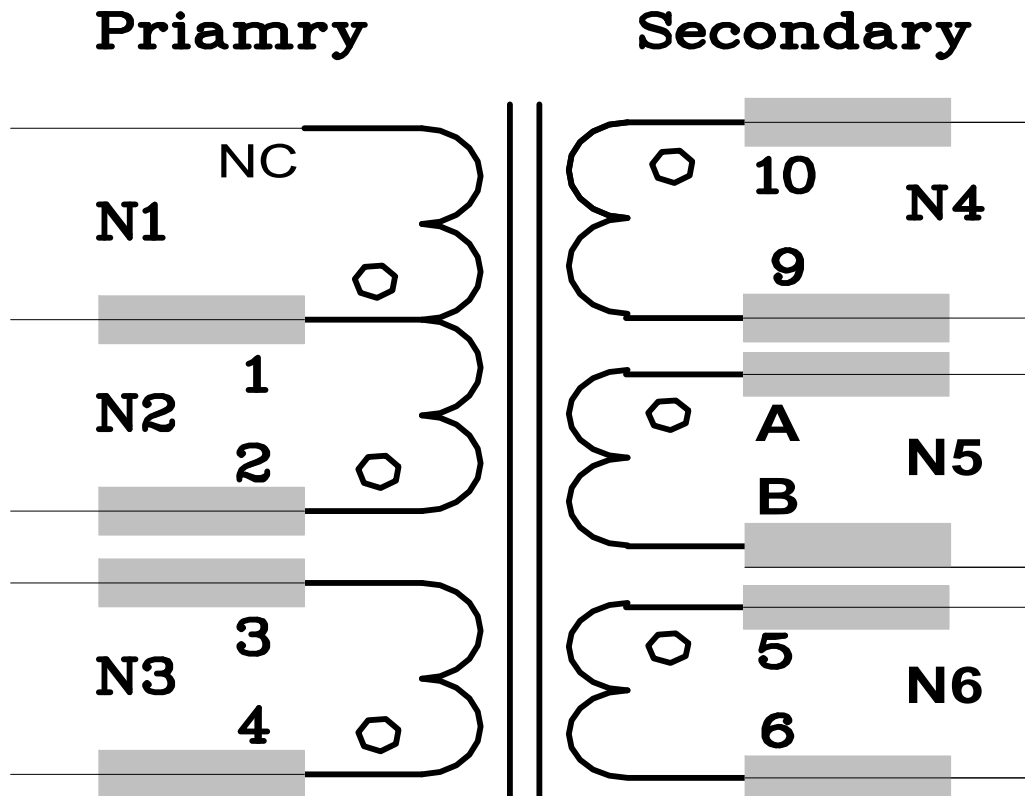

Figure 4—Transformer Electrical Diagram

Notes:

1. All winding terminals are added tube;
2. N5 is flying out from the bobbin. Terminal A is labeled with black and terminal B is labeled with white;
3. Remove Pin7 and Pin8;
4. Varnish the transformer.

Winding Diagram

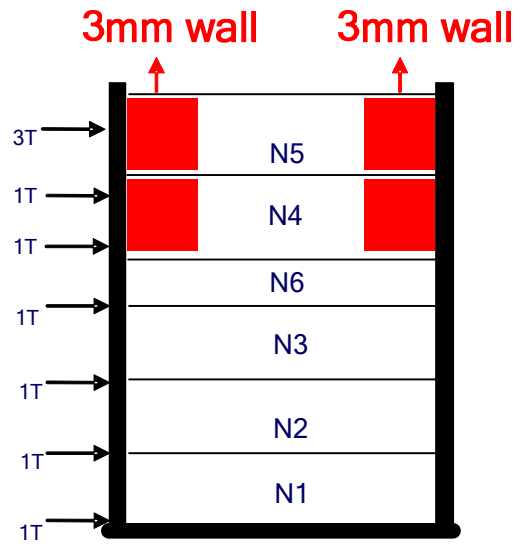

Figure 5—Winding Diagram

Winding Order

Winding No.	Tape Layer No.	Start & End	Magnet Wire ϕ (mm)	Turns
N1	1	1—\(\rightarrow\) NC	0.18mm*2	22
N2	1	2—\(\rightarrow\) 1	0.15mm*1	120
N3	1	4—\(\rightarrow\) 3	0.18mm*3	13
N6	1	5—\(\rightarrow\) 6	0.3mm*1 TIW	15
N4	1	10—\(\rightarrow\) 9	0.16mm*1 TIW	9
N5	1	A—\(\rightarrow\) B	0.16mm*1 TIW	9

Electrical Specifications

Electrical Strength	60 second, 60Hz, from PRI. to SEC.	4500VAC
	60 second, 60Hz, from N4. to N6	4500VAC
	60 second, 60Hz, from PRI. to CORE	500VAC
	60 second, 60Hz, from N5. to CORE	2500VAC
Primary Inductance	Pins 1-2, all other windings open, measured at 60kHz, 0.1VRMS	2.2mH \pm 5%

Materials

Item	Description
1	Core: EF16, UI=2300 \pm 25%, AL=1100nH/N ² \pm 25% UNGAPPED
2	Bobbin: EF16 Vertical, 4+6PIN 1SECT T-H
3	Wire: Φ 0.15mm, 2UEW, Class B
4	Wire: Φ 0.18mm, 2UEW, Class B
5	Triple Insulation Wire: Φ 0.30mm TIW
6	Triple Insulation Wire: Φ 0.16mm TIW
7	Tape: 8.5mm(W) \times 0.06mm(TH)
8	Tube: #26 BLACK; #26 CLEAR; #30 CLEAR; #23 CLEAR
9	Varnish: JOHN C. DOLPH CO, BC-346A or equivalent
10	Solder Bar: CHEN NAN: SN99.5/Cu0.5 or equivalent

CIRCUIT DESCRIPTION

EVHF920-S-00D is designed for smart power meter application with a total triple output power of 4.85W. One output with GND2 connected to L line is designed for the power line communications (PLC) supply.

FR1 is used to protect for the component failure or some excessive short events, also it can restrain the inrush current.

To meet the EN55022 standard, X-CAP CX1 and differential mode inductor LX1 is employed to filter EMI noise.

The diode-bridge rectifier, which is composed of D3, D4, D7 and D8, transforms input AC voltage to the dc-bus voltage.

C6 and C8 are connected in series for a high input voltage energy storage, which help to reduce line noise and protect against the line surge. R2, R6, R10, R12 and R20 are employed to balance the voltage on C6 and C8, and protect the input against over voltage.

The primary RCD consists of R7, C4 and D5, and it can restrain the high voltage spike to protect the MOSFET from damage.

R15 is for switching frequency setup, which should be positioned far away from the data

sampling frequency in power meter applications to avoid unwanted noise disturbance. Moreover, a low switching frequency is commonly used to get good thermal performance under high input voltage application. C19, typically 1nF, is used for double frequency mode selection.

C11 is the power supply capacitor for Vcc, and the ceramic C12 is used in parallel with C11 to decouple the voltage noise, it should be positioned to IC as close as possible.

R21, R22 are the current sense resistors with 1% tolerance for peak current setup.

The output electrolytic capacitor C1 C3 and C9 is used to satisfy the requirement for output voltage ripple.

R1 and R4 is dummy load to regulate the output voltage within designed value.

R14, R18 are configured to set the output voltage. U1, U3, R19 and C13 compose the control loop to feedback the output signal to FB pin and guarantee the quick control loop response and system stability.

Input Line wire is connected to GND2 of main output for input AC frequency sample in power meter.

QUICK START GUIDE

1. Preset power supply to $85\text{VAC} \leq V_{\text{IN}} \leq 350\text{VAC}$.
2. Turn power supply off.
3. Connect the Line and Neutral terminals of the power supply output to L and N port.
4. Connect different loads to corresponding outputs :
 - a. Positive (+): VOUTX
 - b. Negative (-): GNDX
5. Turn power supply on after making connections.

NOTICE: The information in this document is subject to change without notice. Please contact MPS for current specifications. Users should warrant and guarantee that third party Intellectual Property rights are not infringed upon when integrating MPS products into any application. MPS will not assume any legal responsibility for any said applications.